

Chemtech Scientific provides access to this content as a courtesy.
We do not own the content contained in this document.
All rights and credit go directly to its rightful owners.
www.chemtechsci.com
Call us at: 484-424-9415



Vacuum Products Division

***TriScroll™ 300
Series
Dry Scroll
Vacuum Pump***

*MAJOR MAINTENANCE
MANUAL*

Manual No. 699904260

Revision H

February 2011

TriScroll™ 300 Series Dry Scroll Vacuum Pump



TriScroll is a trademark of Agilent, Inc.

Loctite and PST are registered trademarks of Loctite Corporation.

Krytox, Teflon and Viton are registered trademarks of E. I. du Pont de Nemours and Company.

Table of Contents

Declaration of Conformity

Preface vi

Safety Considerations	vi
Related TriScroll Manuals	viii
Maintenance and Tool Kits	viii
Factory Service Options	ix
Contacting Agilent	ix

Major Maintenance..... 1

General Information	1
Required Equipment	1
Maintenance Tool Kit	1
Major Maintenance Kit	2
Tip Seal Kit	4

TriScroll 300 Disassembly..... 5

Remove and Disassemble the Outboard Housing	5
Remove and Disassemble the Orbiting Plate	11
Remove and Disassemble the Inboard Housing	19

Crankshaft Assembly..... 29

Crankshaft Exploded View	29
Assemble the Crankshaft	30

Inboard Housing Assembly..... 33

Inboard Housing Exploded View	33
Inboard Housing Assembly	36
Insert the Shaft Seal	36

Insert the Crankshaft	38
Insert the Seal Housing	40
Install the Vents and Plugs	43
Exhaust Port Reassembly	45
Bypass Port Reassembly	47

Orbiting Plate Assembly..... 51

Orbiting Plate Exploded View	51
Orbiting Plate Assembly	53
Install the Bearing Assembly	53
Install the Wave Washer and Shaft Seal	56
Install the Needle Bearings	59

TriScroll 300 Assembly..... 63

TriScroll 300 Exploded View	64
Final Assembly	67
Install the Orbiting Plate	70
Install the Outboard Housing	78
Install the Sync Crank into the Outboard Housing	82
Replace the Cowling and Cover	84
Put the Pump Back into Service	86

Appendix: Pre- TBD Version of the TriScroll 300 .. 87

TriScroll Disassembly	87
Inboard Housing Assembly	88

Request for Return Health and Safety Certification

Sales and Service Offices

TriScroll 300 Dry Scroll Vacuum Pump

This page intentionally left blank.

Declaration of Conformity
Konformitätserklärung
Déclaration de Conformité
Declaración de Conformidad
Verklaring de Overeenstemming
Dichiarazione di Conformità

We
Wir
Nous
Nosotros
Wij
Noi

declare under our sole responsibility that the product,
erklären, in alleiniger Verantwortung, daß dieses Produkt,
déclarons sous notre seule responsabilité que le produit,
declaramos, bajo nuestra sola responsabilidad, que el producto,
verklaren onder onze verantwoordelijkheid, dat het product,
dichiariamo sotto nostra unica responsabilità, che il prodotto,

TriScroll Series Vacuum Pump

to which this declaration relates is in conformity with the following standard(s) or other normative documents.
auf das sich diese Erklärung bezieht, mit der/den flogenden Norm(en) oder Richtlinie(n) übereinstimmt.
auquel se réfère cette déclaration est conforme à la (aux) norme(s) ou au(x) document(s) normatif(s).
al que se refiere esta declaración es conforme a la(s) norma(s) u otro(s) documento(s) normativo(s).
waamaar deze verklaring verwijst, aan de volende norm(en) of richtlijn(en) beantwoordt.
a cui se riferisce questa dichiarazione è conforme alla/e sequente/I norma/o documento/I normativo/i.

98/37/EEC, Machinery Directive

EN 1012-2:1996	Compressors and Vacuum pumps Safety Requirements; Part 2 Vacuum Pumps
EN 1050:1996	Safety of machinery - principles for risk assessment
EN 60204-1	Electrical equipment of industrial machines; general requirements

73/023/EEC, Low Voltage Directive

EN 60034 part 1	Rotating electrical machines - Part 1: Rating and performance
-----------------	---

89/336/EEC, Electromagnetic Compatibility Directive

EN 61000-4-2	Testing and Measurement Techniques - Electrostatic Discharge Immunity Test
--------------	--



John Ehmann
Operations Manager
Agilent, Inc.
Vacuum Products Division
Lexington, Massachusetts, USA

March 2003

Preface

This manual provides the information you need to successfully perform major maintenance on your TriScroll™ Dry Vacuum Pump. The time to perform major rebuild is typically 18,000 hours of run time. If you have questions that are not addressed in this manual, please contact the nearest Agilent service facility listed on the rear cover of this manual.

Safety Considerations

READ THE FOLLOWING INSTRUCTIONS. TAKE ALL NECESSARY PRECAUTIONS.

The following format is used in this manual to call attention to hazards:

WARNING *The warning messages are for attracting the attention of the operator to a particular procedure or practice which, if not followed correctly, could lead to serious injury.*



CAUTION *The caution messages are displayed before procedures, which if not followed, could cause damage to the equipment.*



NOTE *The notes contain important information taken from the text.*



Maintenance personnel must be aware of all hazards associated with this equipment. They must know how to recognize hazardous and potentially hazardous conditions, and know how to avoid them. The consequences of work performed by unskilled or improperly trained maintenance personnel, or careless operation of the equipment employed in the specified maintenance procedures can be serious.

Every maintenance person must read and thoroughly understand the materials discussed and the instructions provided in this manual, as well as any additional information provided by Agilent.

TriScroll 300 Dry Scroll Vacuum Pump

All warnings and cautions must be read carefully, fully understood, and strictly observed. Consult local, state/province, and national agencies regarding specific requirements and regulations. Address any safety, operation, and/or maintenance questions to the nearest Agilent location.

WARNING *Disconnect power from the TriScroll 300 before performing any maintenance procedure.*



Allow the pump to cool before performing any maintenance procedure. Approximate cool-down time is one to two hours.

CAUTION *Wipe all O-rings clean with a lint-free cloth before installation to ensure that no foreign matter is present to impair the seal.*



Do not use alcohol, methanol or other solvents on O-rings. To do so causes deterioration and reduces their ability to hold a vacuum.

If applicable, apply a small amount of Krytox[®] GPL 224 grease and wipe the O-rings “shiny” dry.

NOTE *Agilent recommends replacing all O-rings during routine maintenance or during any maintenance procedure requiring that O-rings be removed.*



Unless otherwise stated, apply Loctite[®] 242 or Loctite PST[®] to the first few threads only. Apply just enough to obtain a seal.

WARNING *The TriScroll 300 weighs 26.4 kg (58 lbs). To avoid injury, use proper lifting techniques when moving the pump.*



TriScroll 300 Dry Scroll Vacuum Pump

Related TriScroll Manuals

Manuals related to the installation and operation, tip seal and pump module replacement for TriScroll 300 series pumps are listed in the following table:

Title	Applicable TriScroll Model	Part Number
Pump Module Replacement	All TriScroll 300 Series Models	699904285
Tip Seal Replacement Manual	All TriScroll 300 Series Models	699904280
Installation and Operation Manual	All TriScroll 300 Series Models	699904265

Maintenance and Tool Kits

Material and tooling required to perform maintenance on TriScroll pumps is provided in kit form. A description of each kit and ordering information is provided in the following table:

Description	Contents	Applicable TriScroll Model	Part Number
Major Maintenance Kit	All bearings, bearing seals, bearing lubricant, O-rings, and tip seals required to rebuild TriScroll 300 Series pumps.	All TriScroll 300 Series models	PTSS0300MK
Maintenance Tool Kit	All fixtures and tools required to perform any maintenance on TriScroll 300 Series pumps.	All TriScroll 300 Series models	PTSS0300TK
Tip Seal Kit	All tools required to change the tip seals on any TriScroll Series pump.	All TriScroll Series models	PTSTSTKIT
Replacement Tip Seal Set	Replacement tip seals and static O-rings for TriScroll 300 Series pumps.	All TriScroll 300 Series models	PTSS0300TS
	<i>NOTE: The Maintenance Tool Kit or the Tip Seal Kit is required for tip seal replacement.</i>		

Factory Service Options

Agilent offers factory-rebuild service or advance exchange of complete TriScroll Pumps or TriScroll Pump Modules. Contact your nearest Vacuum, Inc. sales office for price and availability information. Select your preferred service option from the table below.

Factory Service Options	Part Number
Advance Exchange TriScroll 300 Single Phase	EXPPTS03001
Advance Exchange TriScroll 300 Three Phase	EXPPTS03003
Advance Exchange TriScroll 310 Single Phase	EXPPTS03101
Advance Exchange TriScroll 310 Three Phase	EXPPTS03103
Advance Exchange TriScroll 300 Pump Module Only	EXPTS0300SC
Advance Exchange TriScroll 310 Pump Module Only	EXPTS0310SC
Service/Rebuild TriScroll 300 Pump (Single or Three Phase)	PTS0300KMA
Service/Rebuild TriScroll 310 Pump (Single or Three Phase)	PTS0310KMA
Service/Rebuild TriScroll 300 Pump Module Only	PTS0300SCRP
Service/Rebuild TriScroll 310 Pump Module Only	PTS0310SCRP

Contacting Agilent

In the United States, you can contact Agilent Customer Service at 1-800-882-7426. See the back cover of this manual for a listing of our sales and service offices.

Visit our web site at:

<http://www.chem.agilent.com/en-US/Products/Instruments/vacuum/pages/default.aspx>.

TriScroll 300 Dry Scroll Vacuum Pump

This page intentionally left blank.

Major Maintenance

General Information

Agilent TriScroll 300 series pumps are designed to provide years of trouble-free service if maintenance procedures and intervals are observed. Bearing grease replenishment and tip seal replacement are recommended when the pump base pressure has risen to an unacceptably high level for your application. Bearings, rotary seals and O-rings should also be replaced if the pump exhibits humming or grinding noises from the bearings. Main bearing life may be shortened if your application requires the pumping of high quantities of water vapor. Use of the bearing purge will keep this water from impacting bearing life.

Required Equipment

- ❑ **Maintenance Tool Kit:** PTSS0300TK
- ❑ **Major Maintenance Kit:** PTSS0300MK
- ❑ **Arbor Press:** 1/2 ton or larger, 10" work diameter capacity, 8" capacity over table
- ❑ **Oven:** 400 °F temperature capability, 11" wide x 11" deep x 4" high minimum chamber, 500 watt or higher heating capacity
- ❑ **Heat Resistant Surface**
- ❑ **Vacuum Gauge:** Capable of measuring pressure of 5 mTorr to 20 mTorr with an accuracy of ± 1 mTorr. A capacitance manometer or Pirani gauge is recommended.

Maintenance Tool Kit



Major Maintenance Kit

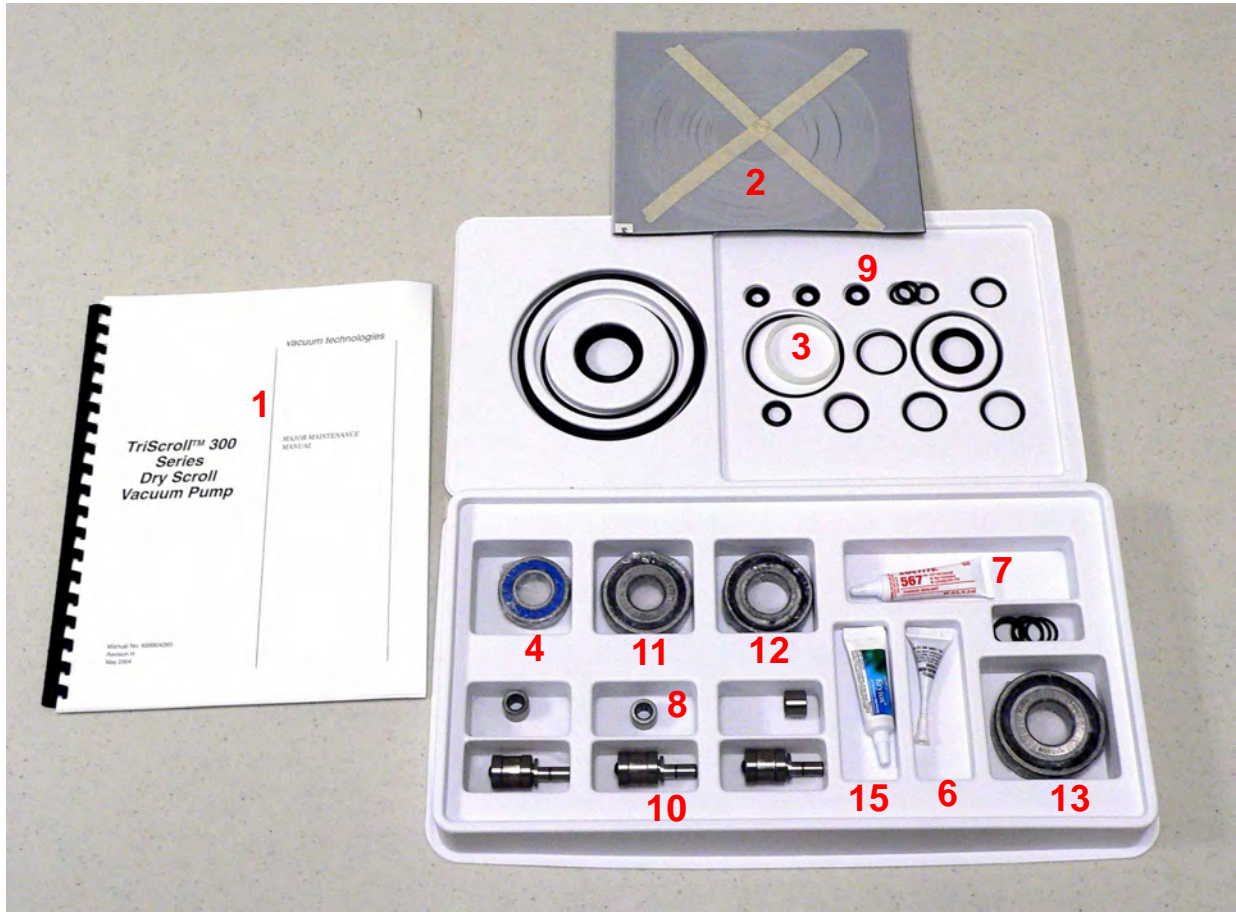

Major Maintenance Kit Components

Item	Description
1	TriScroll 3000 Series Dry Scroll Vacuum Pump Major Maintenance Manual
2	Tip Seal
3	Nylon Sleeve
4	7305BE Bearing
5	Shaft Seal 32X42X4
6	Loctite #242
7	Loctite 567 Pipe Sealant
8	Needle Bearing
9	Shaft Seal 8X15X3

TriScroll 300 Dry Scroll Vacuum Pump

Major Maintenance Kit Components

Item	Description
10	Sync Crank Assemblies
11	6004VRLD Bearing
12	7205DE Bearing
13	7304BE Bearing
14	Shaft Seal 24X32X4
15	Krytox GPL 22 4 Grease

TS-300 O-rings

O-ring Part Number	Quantity	Inside Diameter (in.)	Cross-Section (in.)
2-016	6	0.614	0.070
2-111	3	0.424	0.103
2-115	1	0.674	0.103
2-118	3	0.862	0.103
2-121	1	1.049	0.103
2-137	1	2.050	0.103
2-152	1	3.237	0.103
2-157	1	4.487	0.103
2-205	1	0.421	0.139
2-269	1	8.734	0.139
2-140	1	2.237	0.103

Tip Seal Kit



Tip Seal Tools

TriScroll 300 Disassembly



Remove and Disassemble the Outboard Housing

1. Remove the three M5 screws that attach the cowling to the module.
2. Remove the cowling.



3. Remove the six M5x22 screws that attach the outboard cover to outboard housing.

TriScroll 300 Disassembly (continued)

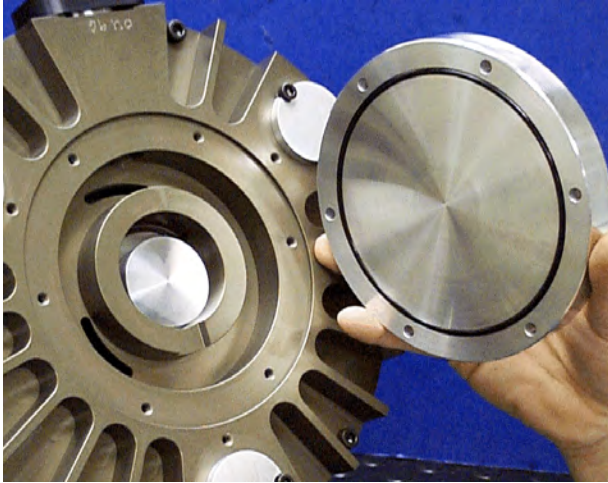

4. Remove the outboard cover.
5. Remove and discard the O-ring.

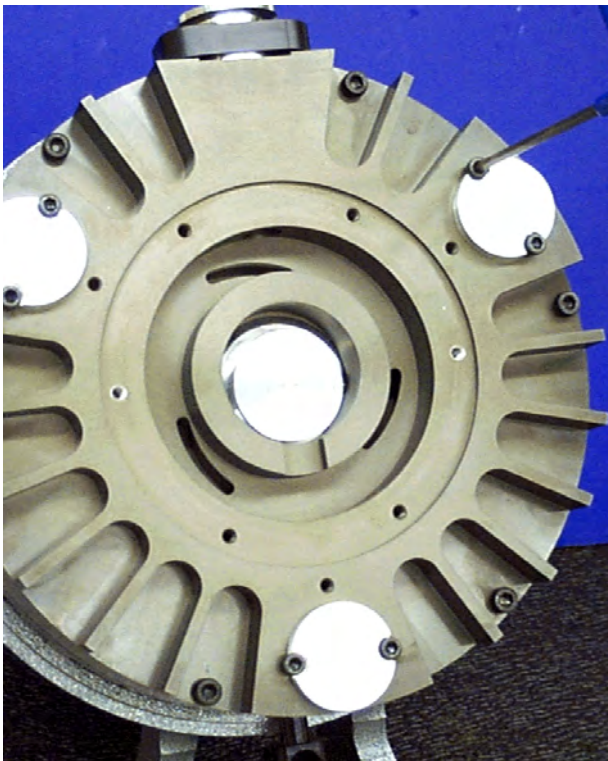

6. Remove the six M5x10 screws that attach the three sync crank covers to the outboard housing.

TriScroll 300 Disassembly (continued)

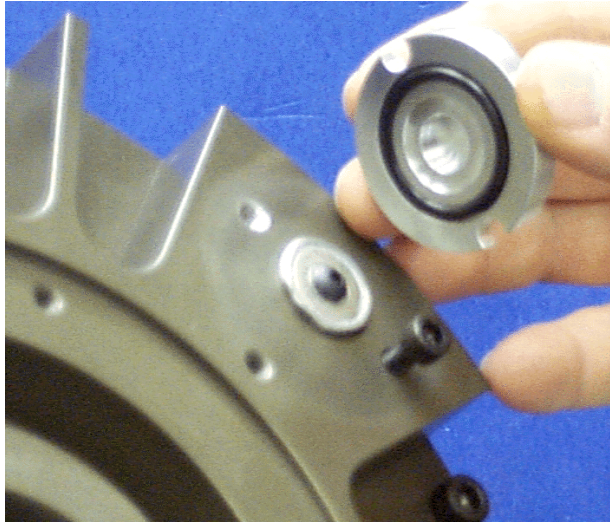

7. Remove the sync crank covers.
8. Remove and discard the O-rings.

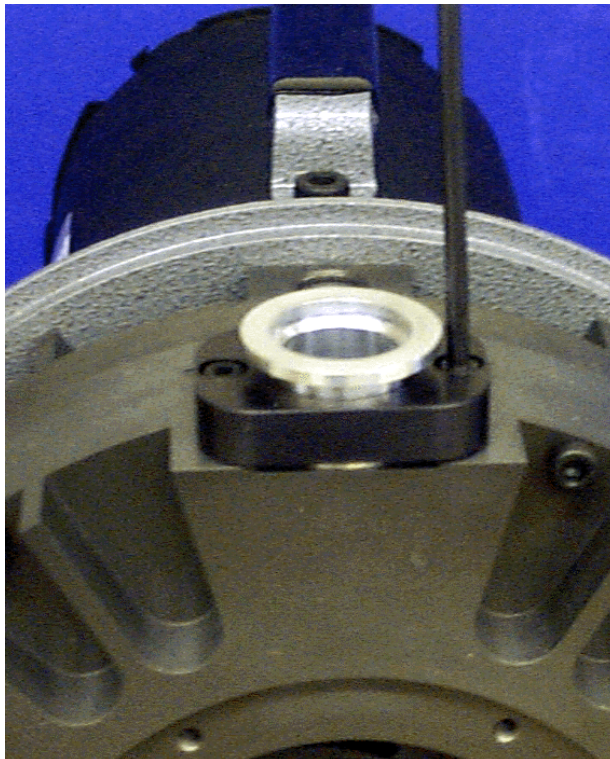

9. Remove the two M5x16 screws that attach the intake clamp to the outboard housing.

TriScroll 300 Disassembly (continued)

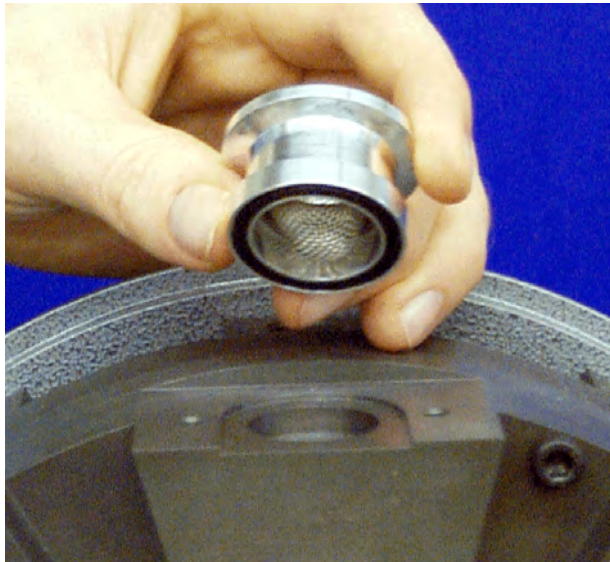

10. Remove the intake clamp and intake fitting.
11. Remove and discard the O-ring.

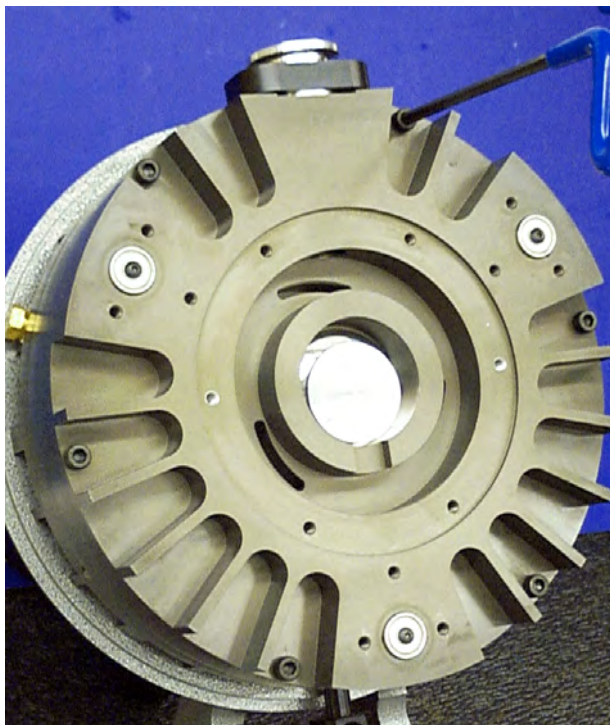

12. Remove the six M6x45 screws that attach the outboard housing to inboard housing.
13. Remove the outboard housing.

TriScroll 300 Disassembly (continued)

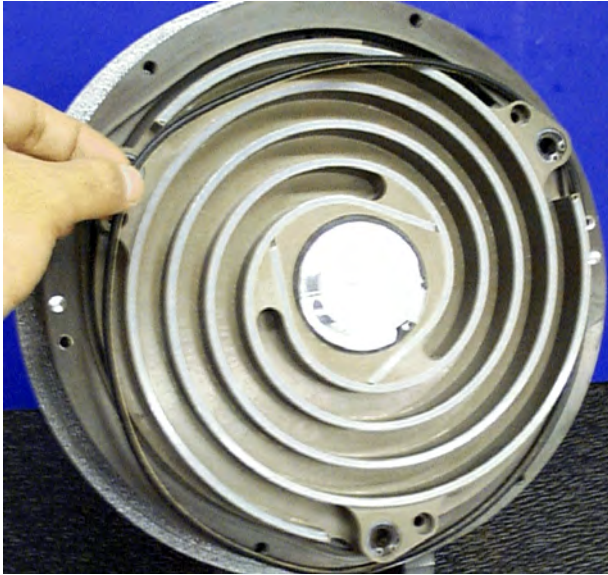

14. Remove and discard the O-ring.

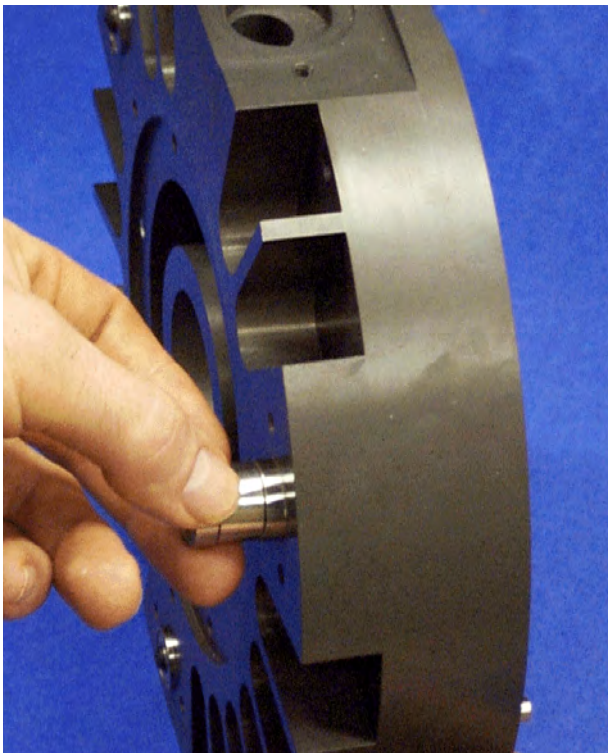

15. Remove and discard the three sync crank assemblies.

TriScroll 300 Disassembly (continued)

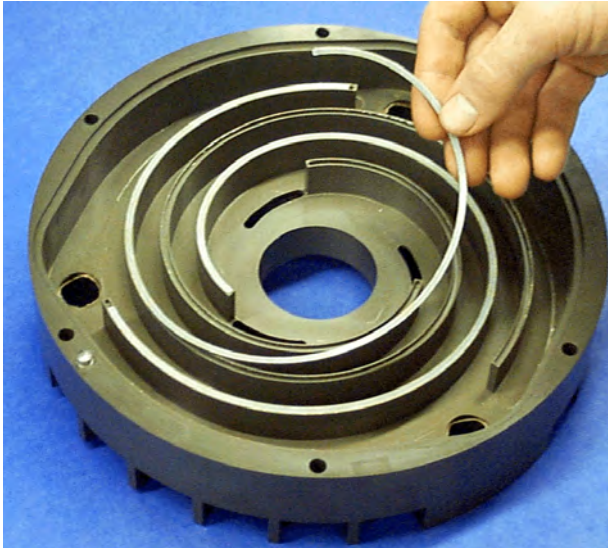

16. Remove and discard the tip seals from the outboard housing.

TriScroll 300 Disassembly (continued)



Remove and Disassemble the Orbiting Plate

17. Remove the snap ring that is holding the orbiting cup in the orbiting plate.

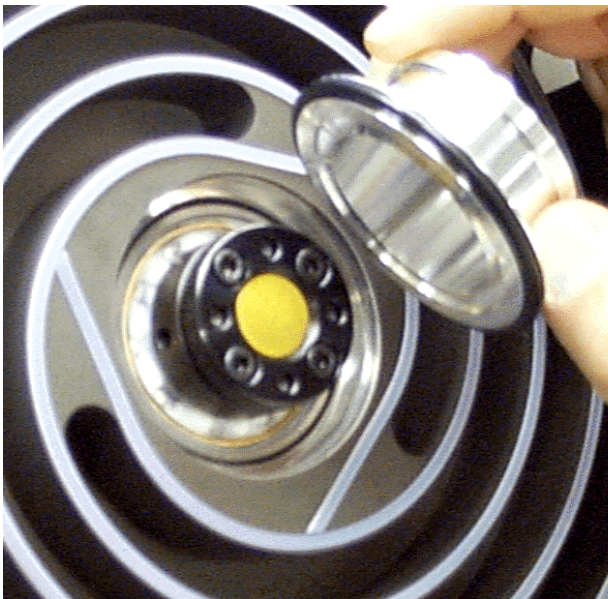

18. Remove the orbiting cup.
19. Remove and discard the O-ring.

TriScroll 300 Disassembly (continued)

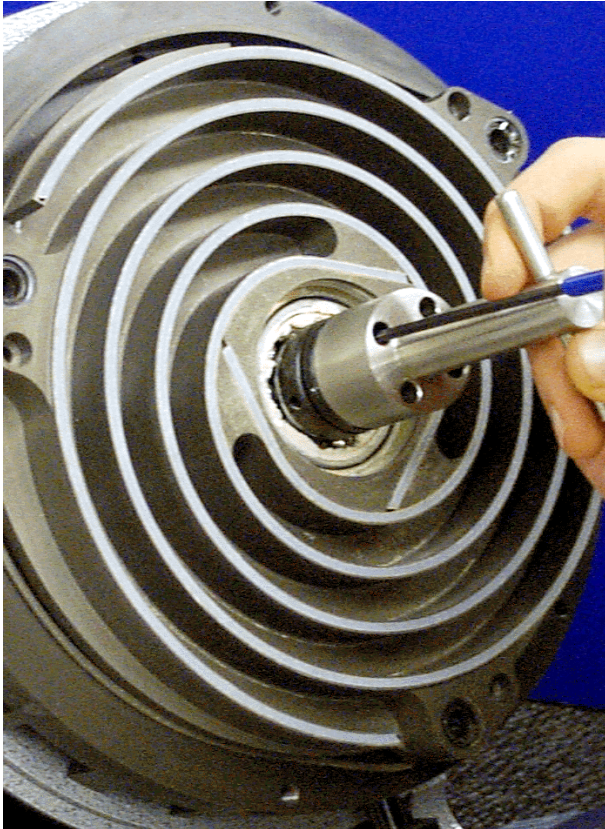

20. Use the locking nut wrench to hold the locking nut.
21. Loosen the four M4x12 screws in the locking nut. Reserve the screws for later use.
22. Remove the locking nut.

TriScroll 300 Disassembly (continued)

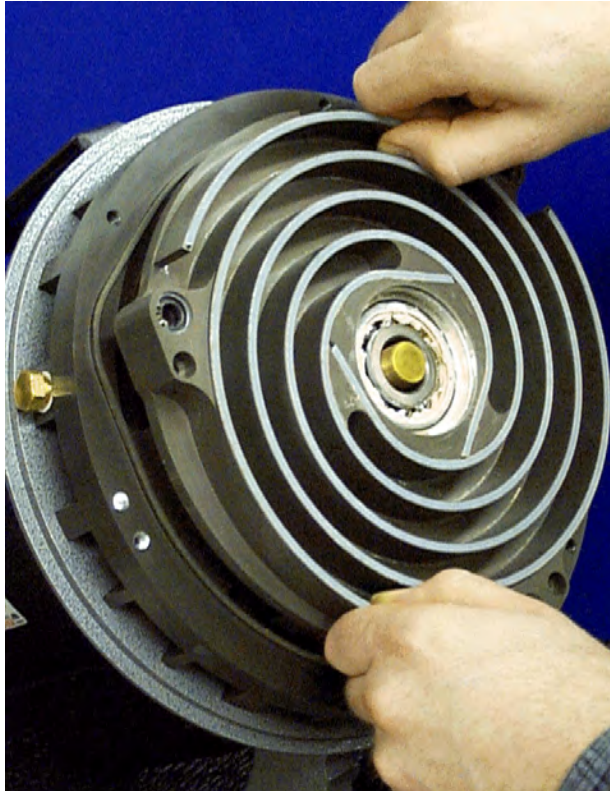

23. Remove the orbiting plate from the crankshaft.



24. Remove and discard the tip seals from both sides of the orbiting plate.

TriScroll 300 Disassembly (continued)

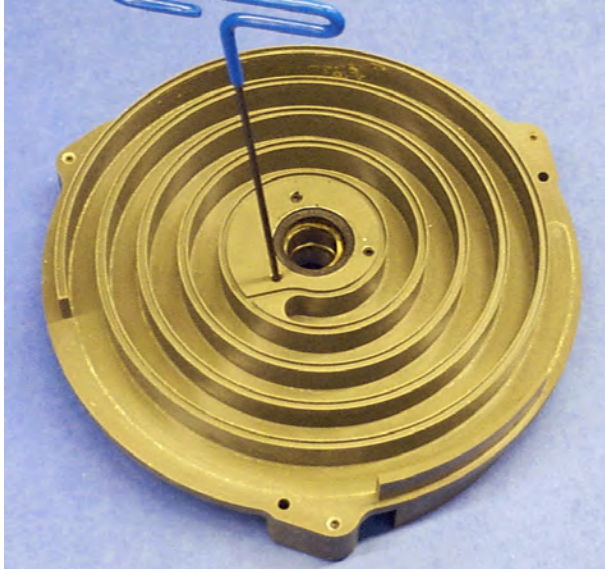

25. Remove the six M5x5 set screws from the orbiting plate.

NOTE



Set screws are held in with Loctite.

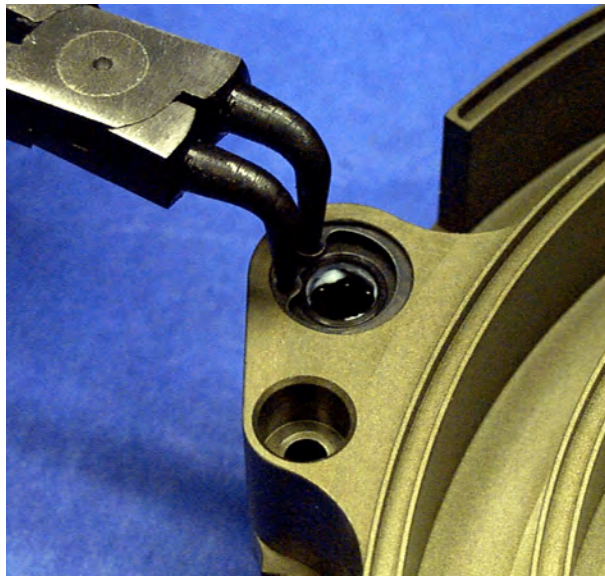

26. Remove the three snap rings holding the needle bearings and shaft seals in the orbiting plate.

TriScroll 300 Disassembly (continued)

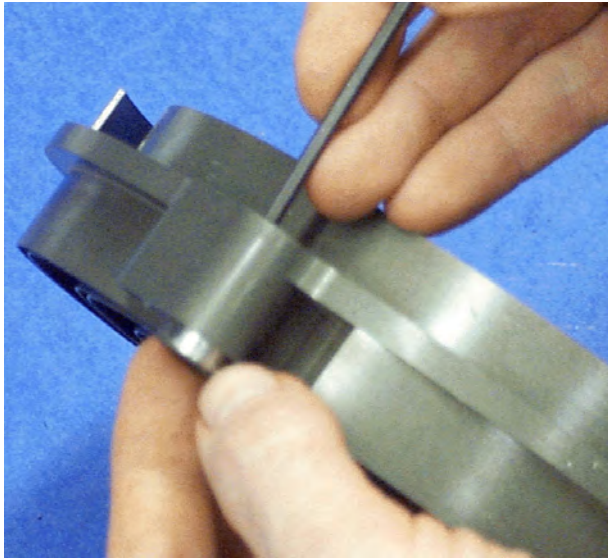

27. Push out and discard the three needle bearings and shaft seals.

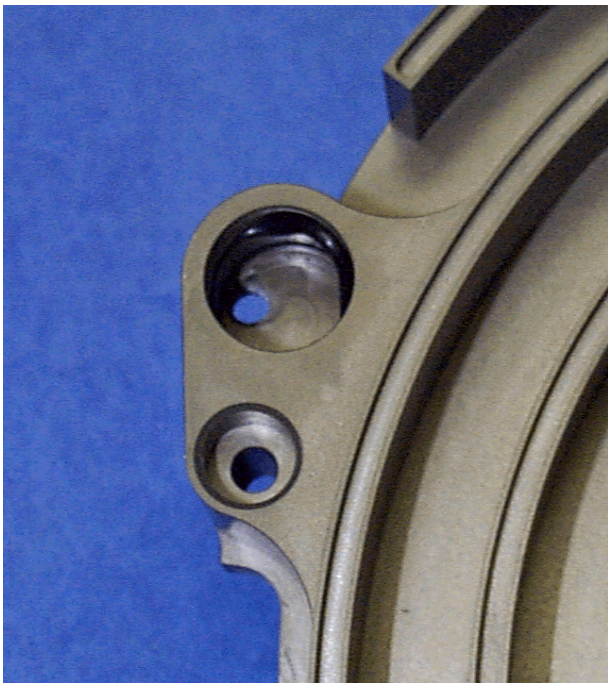

28. Remove and discard the six O-rings from the three sync bearing bores in the orbiting plate.

TriScroll 300 Disassembly (continued)

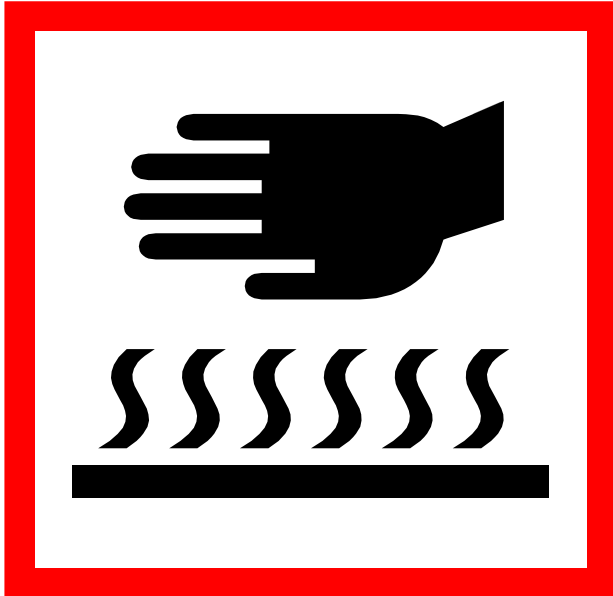

WARNING *This step requires the use of heat resistant gloves. Do not proceed without them!*



29. Heat the orbiting plate for a minimum of 1 hour in a 350 °F oven.

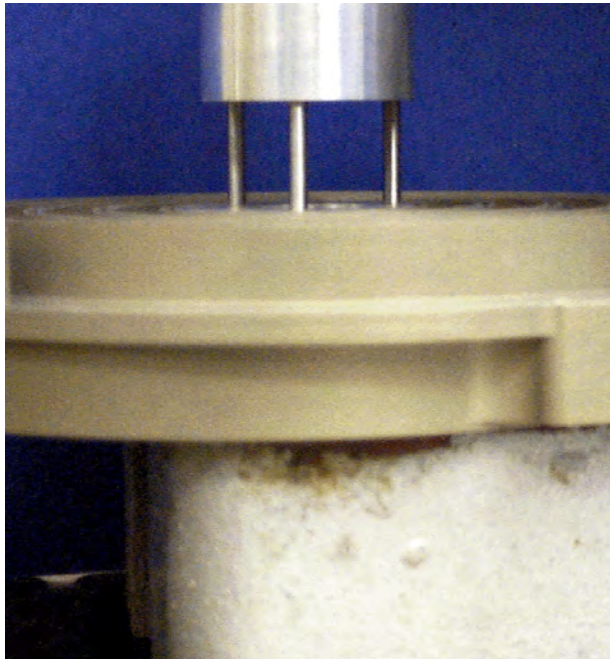

30. Immediately after removing the orbiting plate from oven, use the bearing extractor tool and arbor press to press out the two bearings, orbiting spacer, nylon sleeve and wave washer from the orbiting plate.

The parts are shown in the photo on page 17.

TriScroll 300 Disassembly (continued)



The parts removed from the orbiting plate are:

- ① Wave washer
- ② Nylon sleeve
- ③ 7305 or 7305BE bearing
- ④ J9104P or 6004VRLD bearing
- ⑤ Orbiting spacer

31. Allow the orbiting plate to air cool until it can be handled with bare hands.

This generally takes a few hours.

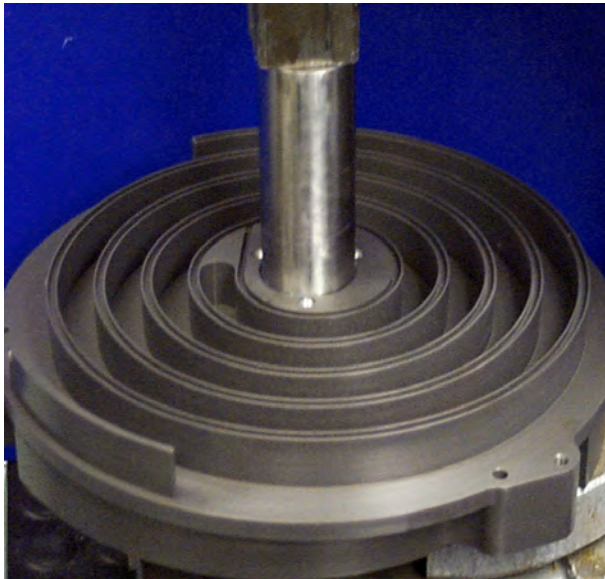

32. Remove and discard the shaft seal from the orbiting plate.

TriScroll 300 Disassembly (continued)

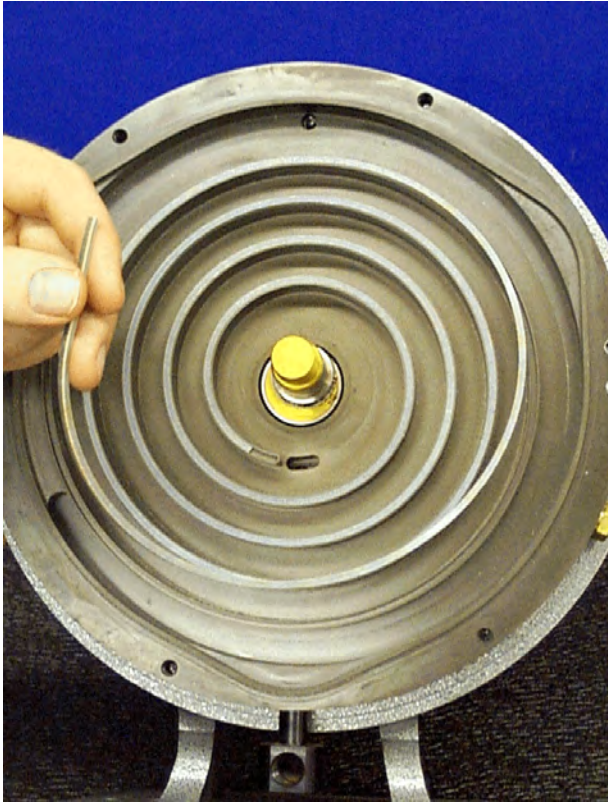

33. Remove and discard the tip seal from the inboard housing.

TriScroll 300 Disassembly (continued)

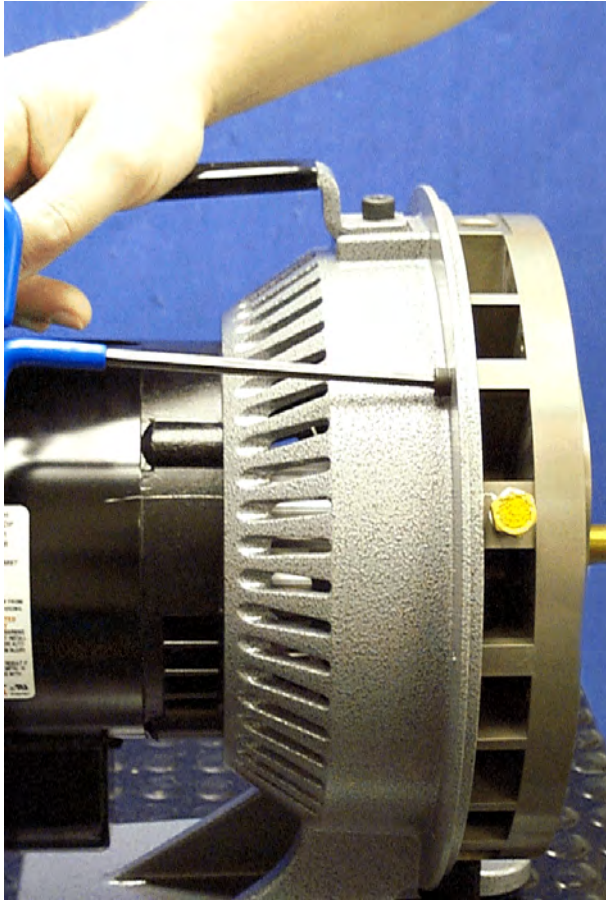

Remove and Disassemble the Inboard Housing

1. Remove the four M6x16 screws that attach the inboard housing to the frame.

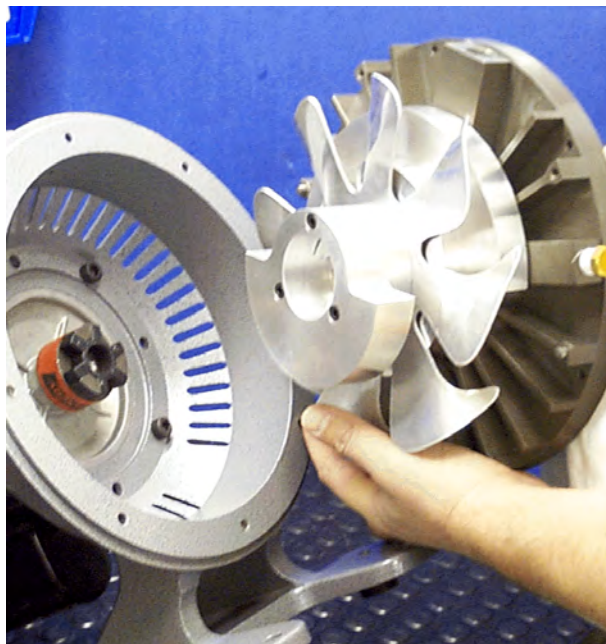

2. Remove the inboard housing from the frame.

TriScroll 300 Disassembly (continued)

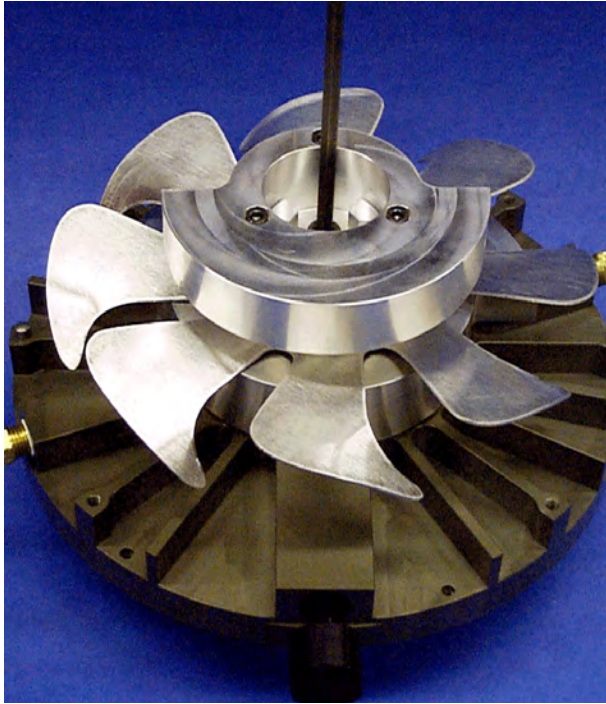

3. Remove the M8x12 screw and washer that attach the fan assembly to the crankshaft, then remove the fan assembly.

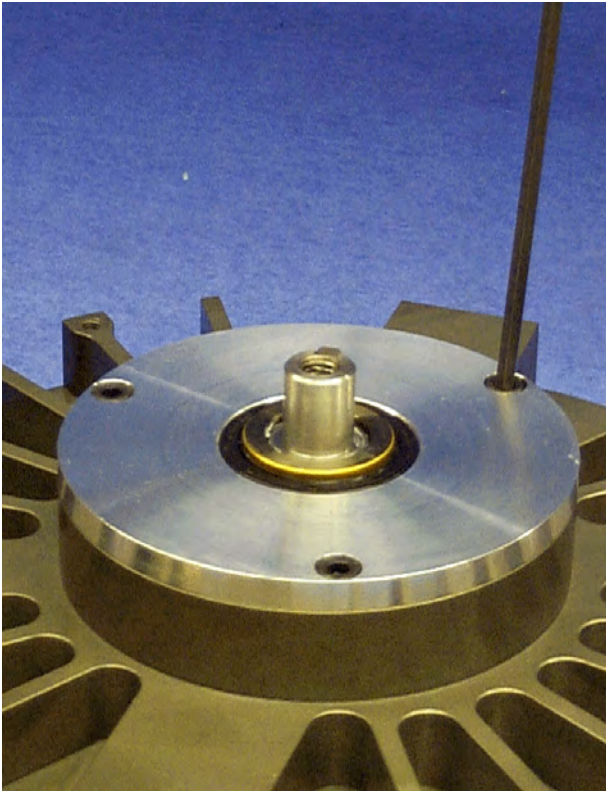

4. Remove the three M5x10 screws that hold the seal housing to the inboard housing.

TriScroll 300 Disassembly (continued)



5. Remove the seal housing.
6. Remove and discard the O-rings and the shaft seal from seal housing.

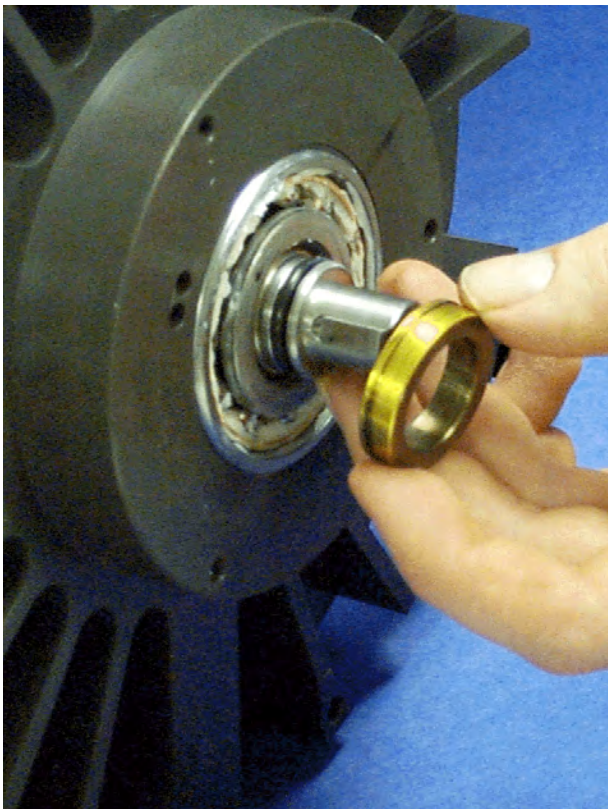

7. Remove the shaft seal spacer from the crankshaft.

TriScroll 300 Disassembly (continued)

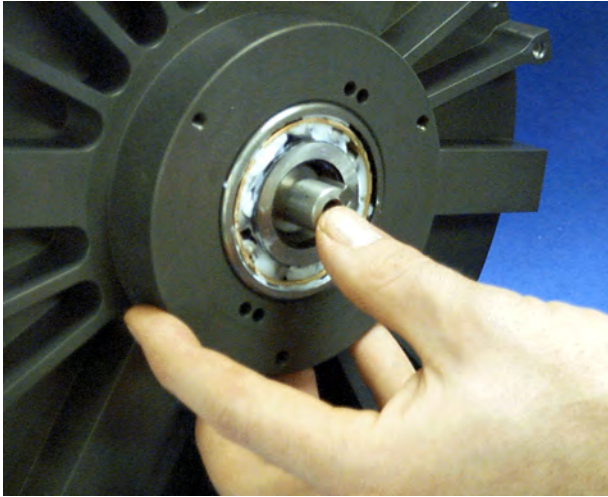

8. Push the crankshaft out of the inboard housing.
9. Remove the key from slot in the crankshaft.
10. Remove and discard the O-ring from the crankshaft.

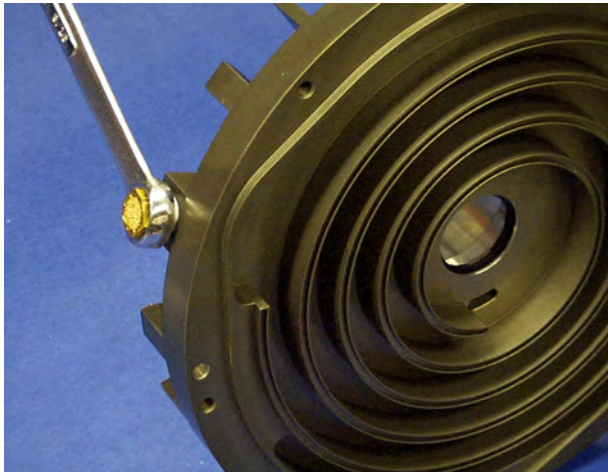

11. Remove the two pipe plugs from the inboard housing.

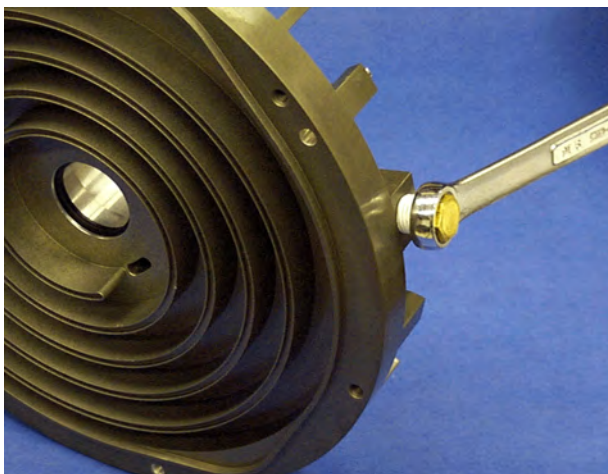

TriScroll 300 Disassembly (continued)

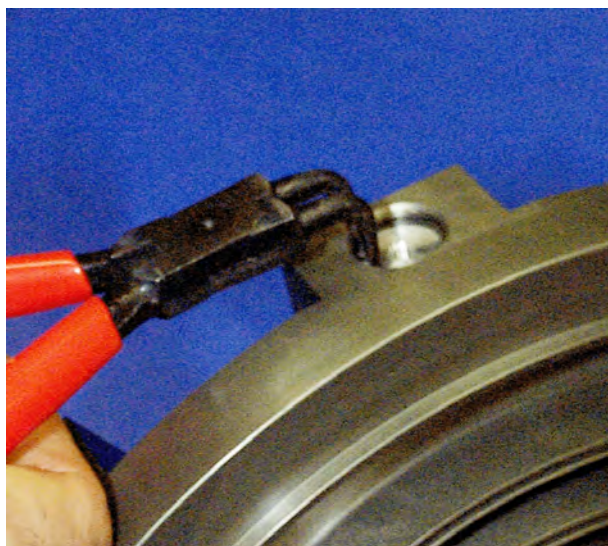

12. Remove the snap ring that is holding the bypass cover in the inboard housing.



13. Remove the bypass cover and spring.



14. Remove the check valve plug by installing an M4 screw and then pulling out the plug. Use the screw from step 21 for this.

15. Remove and discard the three O-rings.

TriScroll 300 Disassembly (continued)

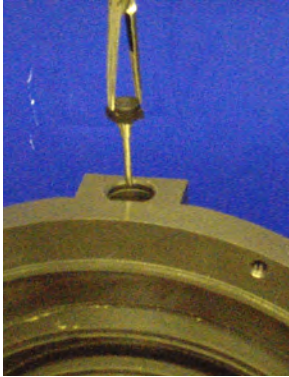

16. Using the hemostat pliers, remove the two check valves, two small springs, plunger guide and spacer from the port in the inboard housing.

See TBD for units manufactured prior to TBD.

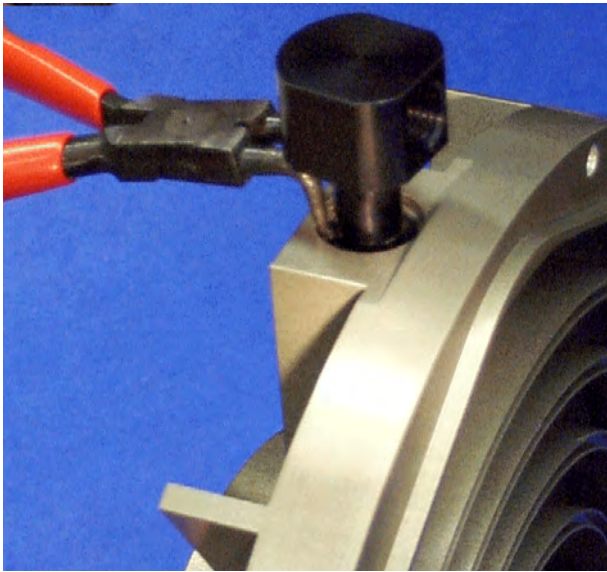

17. Remove the snap ring that is holding the exhaust fitting in the inboard housing.

TriScroll 300 Disassembly (continued)



18. Remove the exhaust fitting.

19. Remove and discard the O-ring.

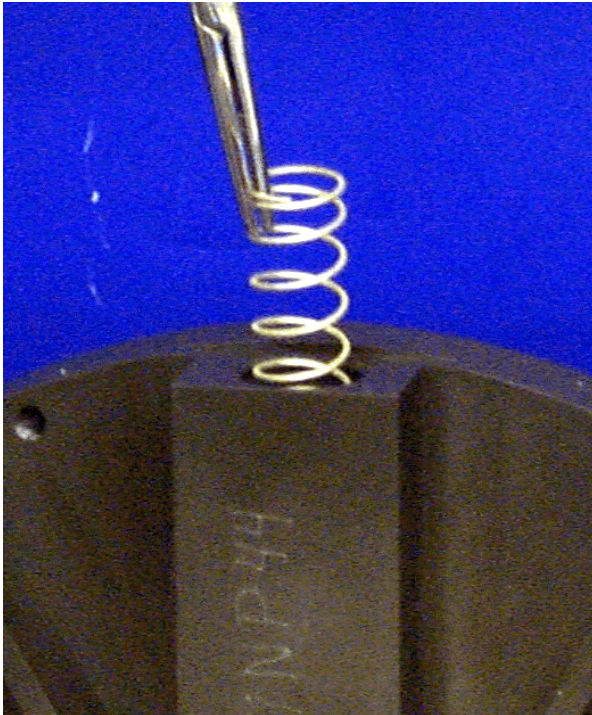

NOTE

The next step applies to all models except the 310.



20. Using the hemostat pliers, remove the large spring, plunger guide, small spring and check valve from the exhaust port in the inboard housing.

TriScroll 300 Disassembly (continued)

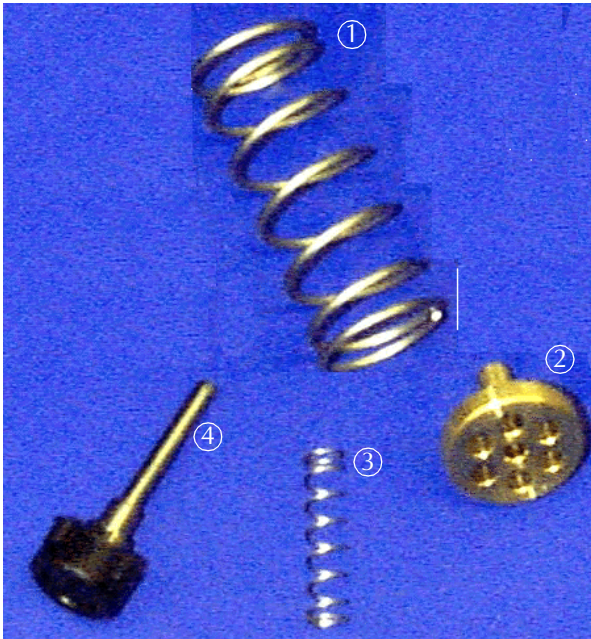

The parts removed from the exhaust are:

- ① Large spring
- ② Plunger guide
- ③ Small spring
- ④ Check valve

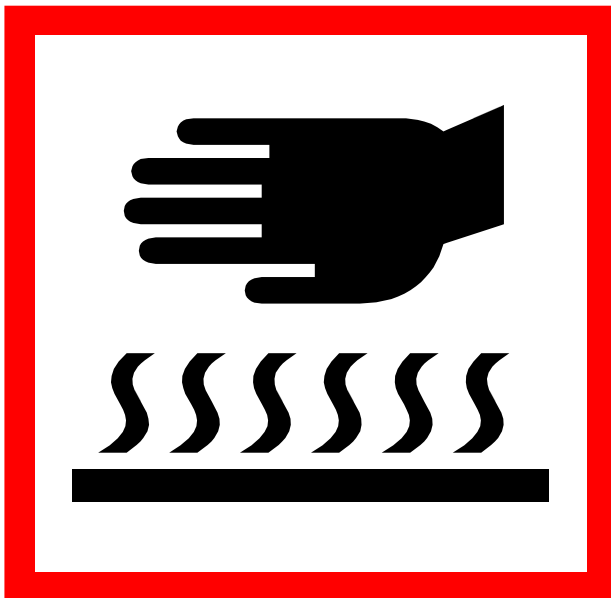

WARNING *This step requires the use of heat resistant gloves. Do not proceed without them!*



21. Heat the inboard housing for a minimum of 1 hour in a 350 °F oven.

TriScroll 300 Disassembly (continued)

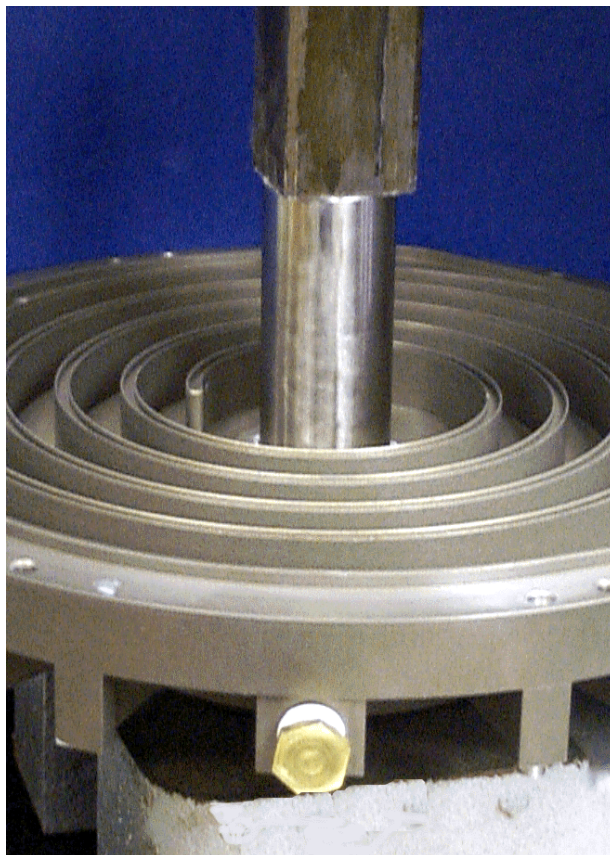

22. Immediately after removing the inboard housing from oven, remove the two bearings, bearing spacer and wave washer from inboard housing.
23. Use the main bearing extractor tool to push bearings out if the bearings do not fall out.



The parts removed from the inboard housing are:

- ① Bearing spacer
- ② 7205W SU or 7205DE bearing, included in maintenance kit
- ③ 7305WN SU or 7305BE bearing, included in maintenance kit
- ④ Wave washer

TriScroll 300 Disassembly (continued)

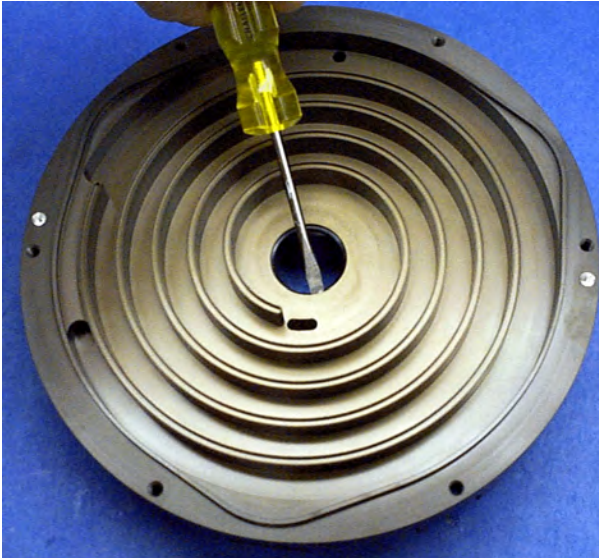

24. Allow the inboard housing to air cool until it can be handled with bare hands.
25. Remove and discard the shaft seal from the inboard housing.

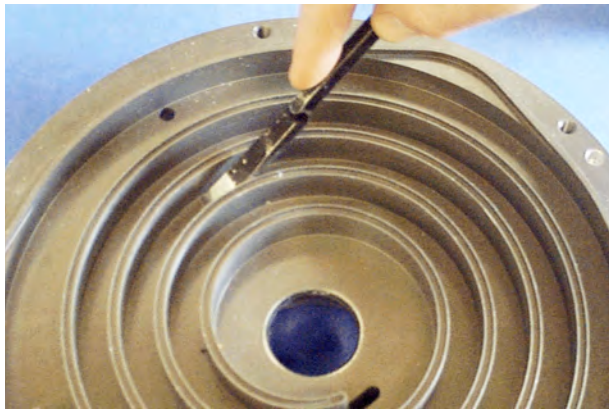

26. Carefully scrape with a chisel to loosen the tip seal dust from the orbiting plate, inboard and outboard housing. If seal debris is attached to the sides of the scroll walls, use a razor blade or Exacto knife to scrape this debris off.
27. Use dry compressed air to remove the tip seal debris.
28. Clean all the parts.

NOTE



The use of an industrial detergent and water is recommended.

29. Ensure that all parts are dry.

Crankshaft Assembly

Crankshaft Exploded View

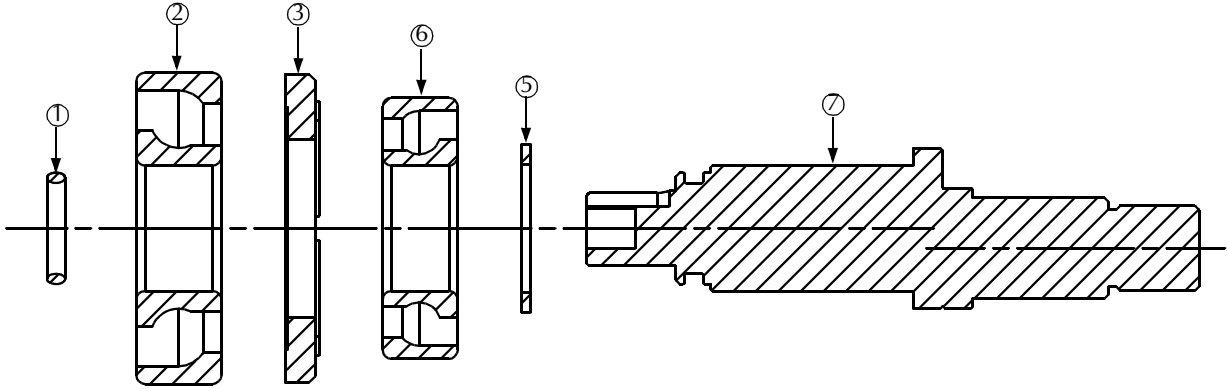

Callout	Part Number	Description	Quantity
①	MK*	2-115 Viton [®] O-ring	1
②	MK*	7305BE Bearing	1
③	S4770001	VDS4- Bearing Spacer	1
⑤	S4769001	Wave Washer - Crank	1
⑥	MK*	7205DE Bearing	1
⑦	S4711001	VDS4- Crankshaft	1

MK = Included in major maintenance kit

TSK = Included in tip seal kit

NSS = Not sold separately

Assemble the Crankshaft

Tools required:

- ❑ Allen wrench
- ❑ Bearing pre-load tool
- ❑ Arbor press
- ❑ Krytox GPL 224 grease, included in maintenance kit



Locate the following parts shown in the photo to the left:

- ① Crankshaft
- ② Bearing spacer
- ③ 7205DE bearing, included in maintenance kit
- ④ Seal spacer
- ⑤ 7305BE bearing, included in maintenance kit
- ⑥ Wave washer-crank
- ⑦ O-ring, 2-115, included in maintenance kit

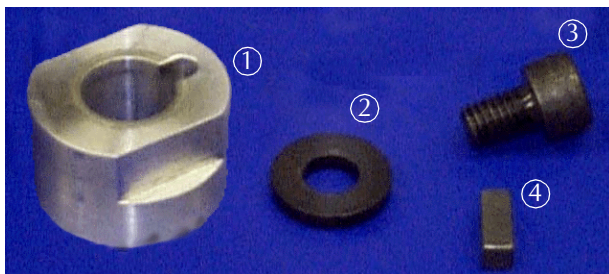

Locate the following parts in the photo to the left:

- ① Bearing pre-load tool
- ② Washer
- ③ M8x12 screw
- ④ 5x5x12 key



1. Install the wave washer onto the crankshaft.

Assemble the Crankshaft (continued)

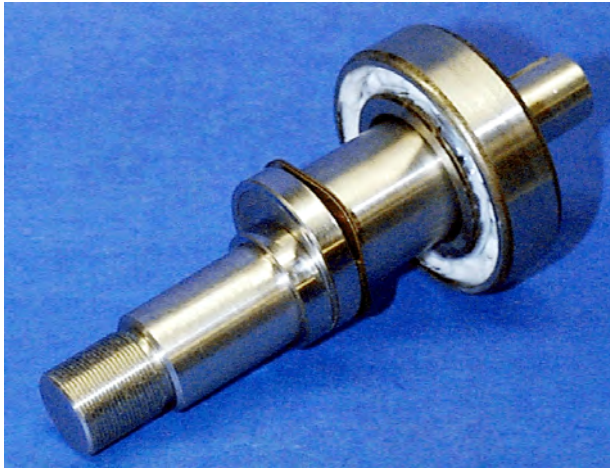

2. Install 7205DE bearing on crankshaft.

Observe Proper Orientation



↓
Toward Wave Washer

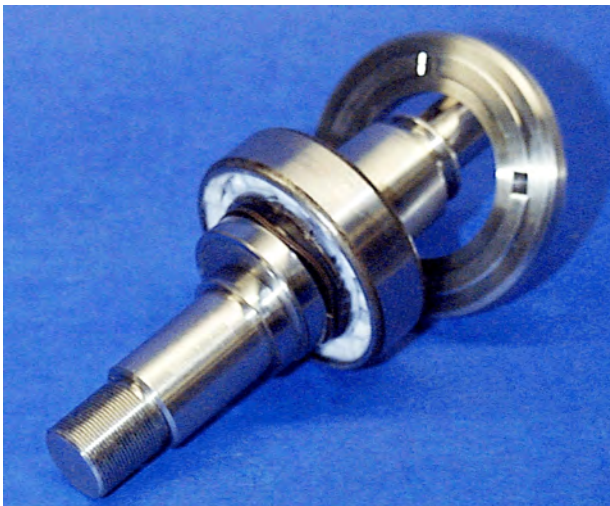

3. Install bearing spacer on crankshaft.

Observe Proper Orientation

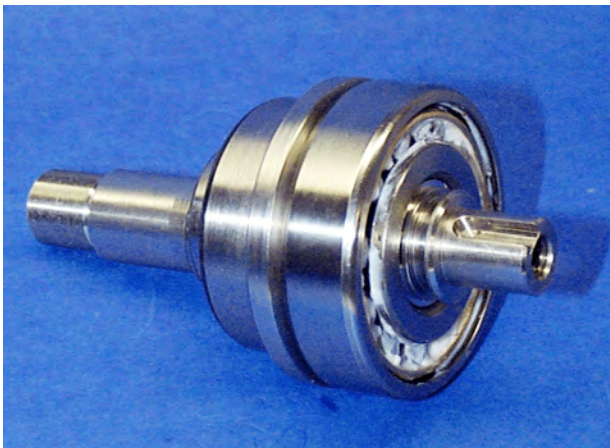

4. Install 7305BE bearing on crankshaft.

Observe Proper Orientation



↓
Toward Wave Washer

Assemble the Crankshaft (continued)

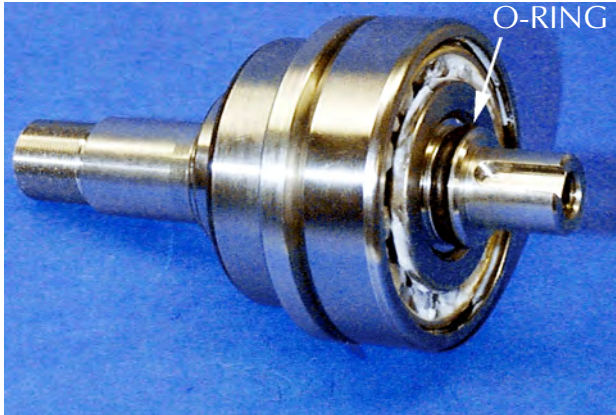

5. Lightly grease the O-ring and install it in the groove on the crankshaft.
6. Install the key in the slot.
7. Install the seal spacer over the O-ring.

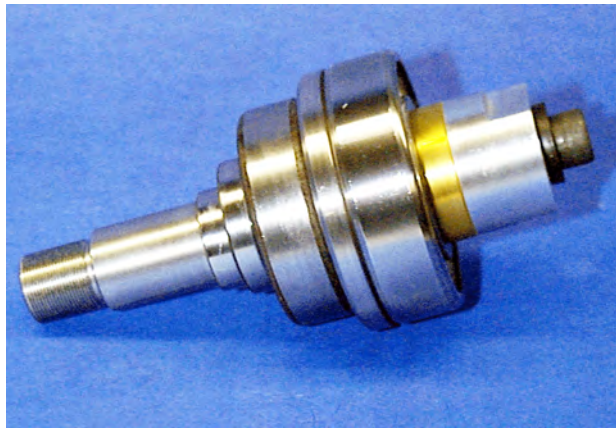

8. Slide the bearing pre-load tool onto the crankshaft engaging key and secure it with the M8x12 screw and washer. Assure that the outside diameter of the bearing spacer is centered on the OD of the 7305BE bearing.

Inboard Housing Assembly

Inboard Housing Exploded View

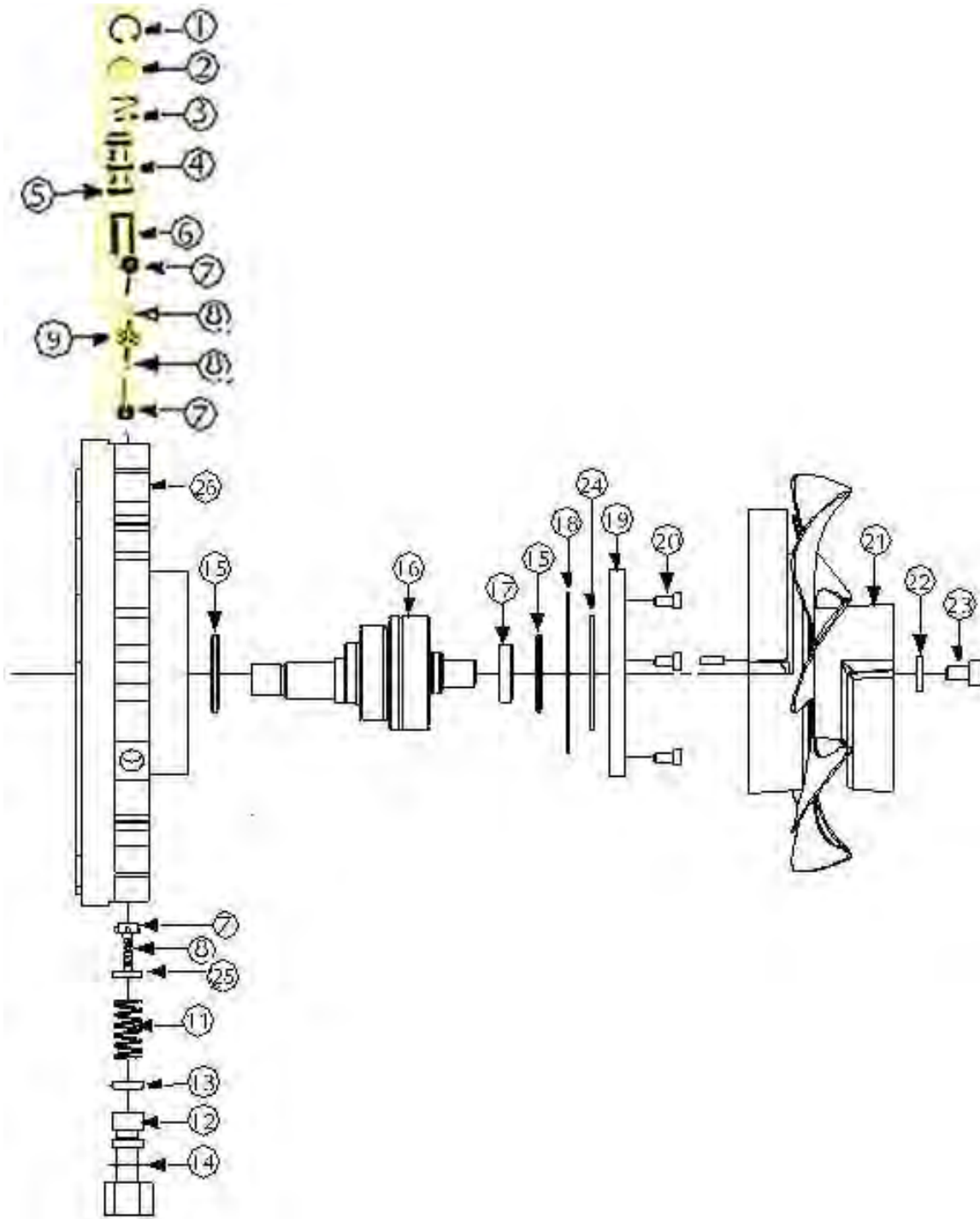

TriScroll 300 Dry Scroll Vacuum Pump

Callout	Part Number	Description	Quantity	
			PTS03101UNIV, PTS03103UNIV	PTS03001UNIV, PTS03003UNIV
①	NSS*	Snap Ring N500-62	1	1
②	S4855001	VDS4- Bypass Cover	1	1
③	660285565	Spring, S/S, .60 OD x .50 L x .045 Wire OD	1	1
④	S4851001	Check Valve Plug	1	1
⑤	MK*	O-ring, Viton 2-111	3	3
⑥	S4853001	VDS4- Check Valve Spacer	1	1
⑦	S4856001	VDS4- Check Valve Assembly	2	3
⑧	660285573	Spring, S/S, .18 OD x .75 L x .014 Wire OD	2	3
⑨	S4852001	VDS4- Plunger Guide	1	1
⑪	660285568	Spring, S/S, .60 x 1.50 L x .045 Wire OD	-	1
⑫	S4706001	VDS4- Exhaust Fitting	1	1
⑬	MK*	O-ring, Viton 2-205	1	1
⑭	NSS*	Snap Ring, N5000-75	1	1
⑮	MK*	Shaft Seal, 32mm x 42mm x 4mm	2	2
⑯	NSS*	VDS4- Crankshaft Assembly	1	1
⑰	S4727001	VDS4- Seal Spacer	1	1
⑱	MK*	O-ring, Viton 2-152	1	1
⑲	S4712001	VDS4- Seal Housing	1	1
⑳	NSS*	Screw, Socket Head Cap, M5x10, Black Steel	3	3
㉑	NSS*	VDS4- Fan Assembly	1	1
㉒	NSS*	Washer, 11/32 x 3/4 x 1/8	1	1
㉓	NSS*	Screw, Socket Head Cap, M8x12, Black Steel	1	1
㉔	MK*	O-ring, Viton 2-140	1	1

MK = Included in major maintenance kit

TSK = Included in tip seal kit

NSS = Not sold separately

TriScroll 300 Dry Scroll Vacuum Pump

Callout	Part Number	Description	Quantity	
			PTS03101UNIV, PTS03103UNIV	PTS03001UNIV, PTS03003UNIV
②⑤	S4854001	Plunger Guide	1	1
②⑥	NSS*	VDS4- Inboard Housing	1	1

MK = Included in major maintenance kit

TSK = Included in tip seal kit

NSS = Not sold separately

Inboard Housing Assembly



Insert the Shaft Seal

Tools required:

- Arbor press
- Seal installation tool
- Krytox GPL 224 grease

Locate the following parts shown in the photos to the left:

- ① Shaft seal, 32x42x4, included in maintenance kit
- ② Inboard housing

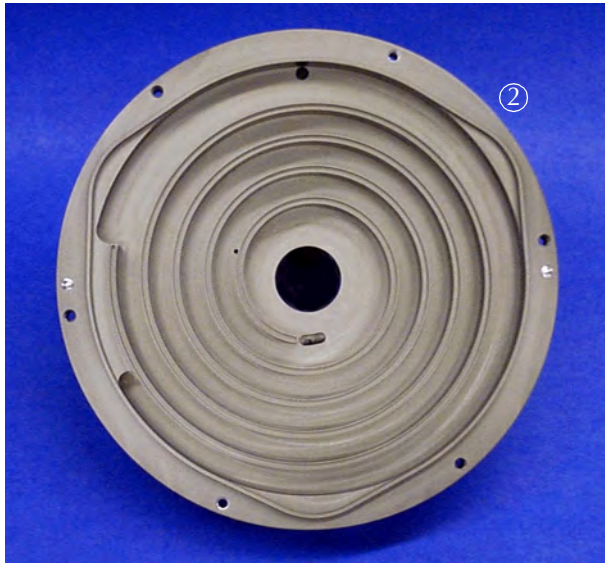

Inboard Housing Assembly (continued)



1. Using Krytox GPL 224, grease the inner diameter of the shaft seal between its lips.

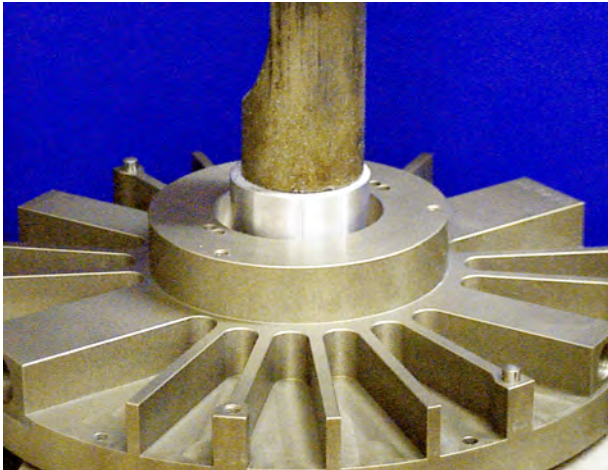

2. Using the seal insertion tool, press the shaft seal (32x42x4) into the bore of inboard housing from the fin side.

Observe Proper Orientation

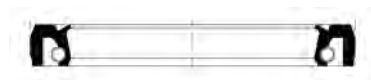

↓
Into Bore

Inboard Housing Assembly (continued)

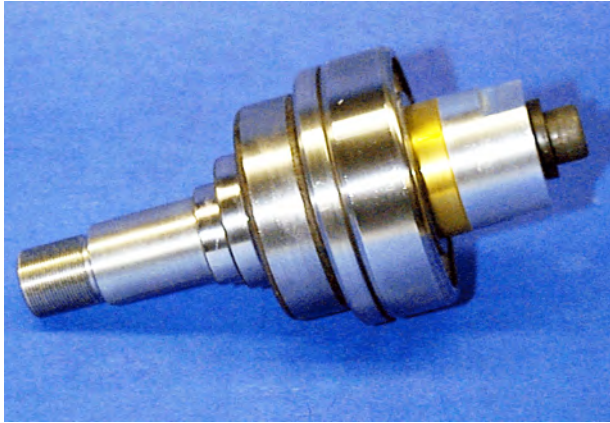

Insert the Crankshaft

Tools required:

- Cooling stand
- Gloves

Locate the following items:

- Crankshaft assembly
- Inboard housing

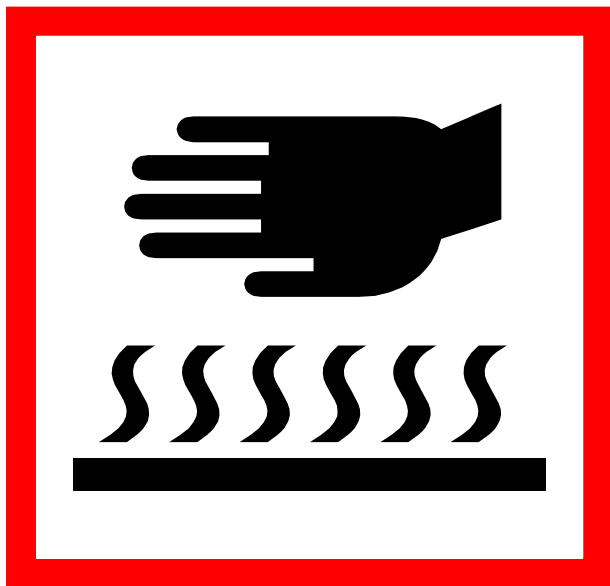
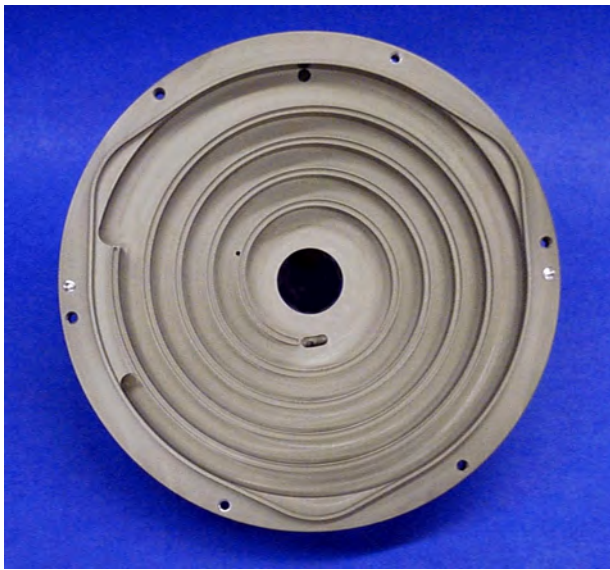

WARNING *This step requires the use of heat resistant gloves. Do not proceed without them!*



1. Heat the inboard housing for a minimum of 1 hour in a 350 °F oven.

Inboard Housing Assembly (continued)

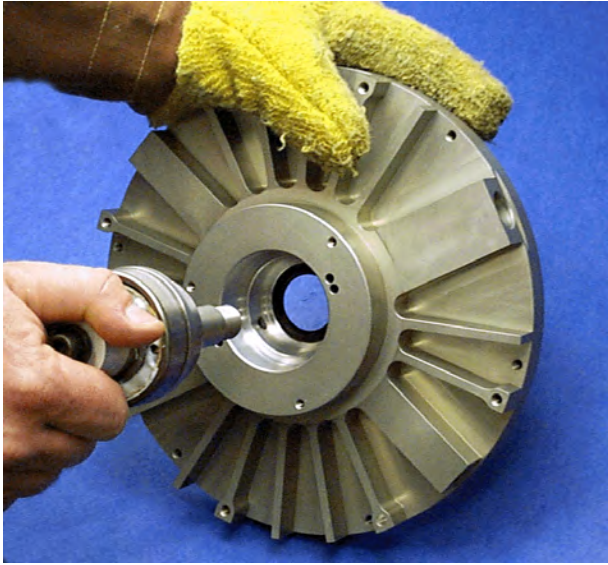

WARNING *Assembly is hot. Use heat resistant gloves for this step.*



2. Immediately after removing the inboard housing from oven, push the crankshaft assembly into the inboard housing, external threads first.

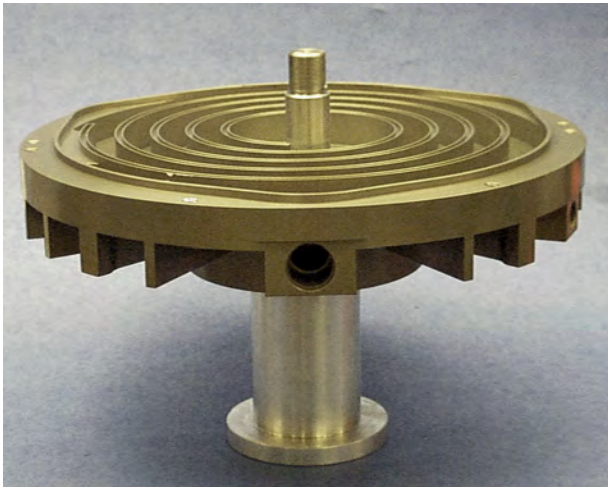

3. Place assembly in cooling stand and allow to air cool.

CAUTION *Be careful not to let crankshaft drop out.*



Inboard Housing Assembly (continued)



Insert the Seal Housing

Tools required:

- Allen wrench
- Seal installation tool
- Krytox GPL 224 grease
- Locite[®] 242

Locate the following parts shown in the photo on the left:

- ① Seal housing
- ② Shaft seal, 32x42x4, included in maintenance kit
- ③ M5x10 screw (3)
- ④ O-ring, 2-152, included in maintenance kit
- ⑤ O-ring, 2-140, included in maintenance kit

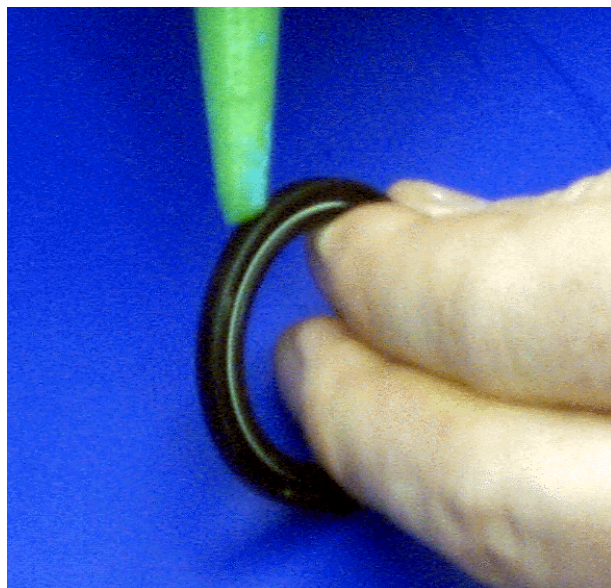

1. Spread a thin film of Locite[®] 242 onto the outer surface of the shaft seal, (32x42x4).

Inboard Housing Assembly (continued)

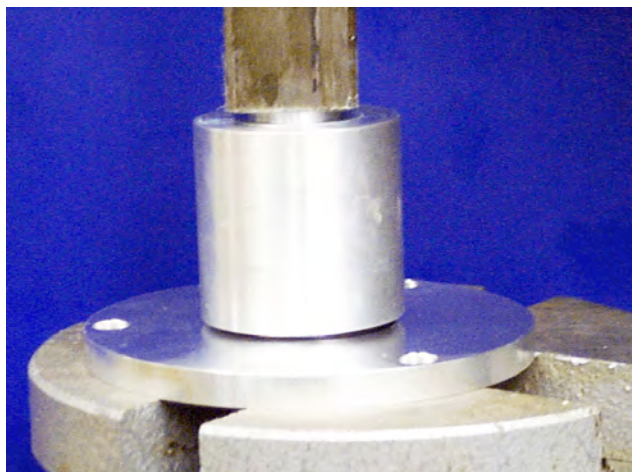

2. Press the shaft seal into the seal housing.

Observe Proper Orientation

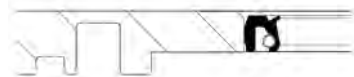

3. Using Krytox GPL 224, grease the inner diameter of the shaft seal between lips.
4. Remove the screw, washer and bearing pre-load tool from crankshaft.
5. Lightly grease the 2-152 O-ring and insert it into the outer groove on the seal housing.
6. Lightly grease the 2-140 O-ring and insert it into the middle groove on the seal housing.

Inboard Housing Assembly (continued)

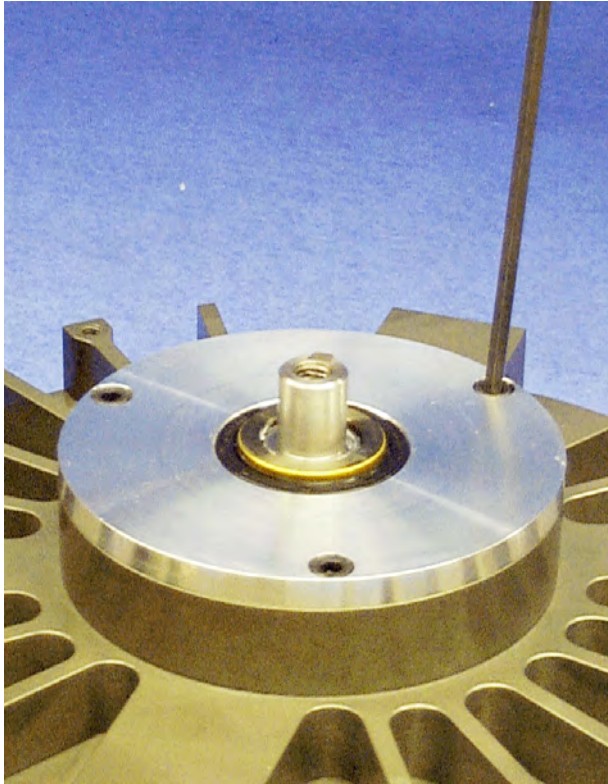

7. Secure the seal housing to the inboard housing with three M5x10 screws.
8. Tighten the screws to 75 in-lb.

CAUTION



Avoid damage to the seal. Carefully rocking the seal housing onto the crankshaft will avoid damage to the seal during installation.

9. Place the key into the slot in the crankshaft.

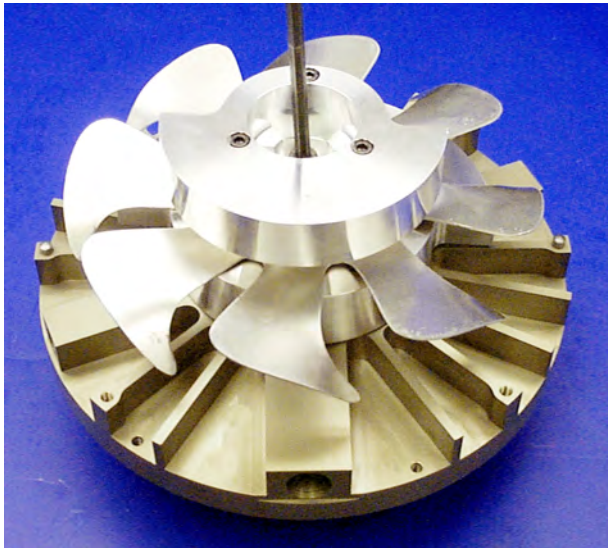

10. Slide the fan assembly onto the crankshaft, engaging the key and against the seal spacer.
11. Secure with the M8x12 screw and washer previously removed (see page 20).
12. Tighten screws to 250 in-lb.

Inboard Housing Assembly (continued)

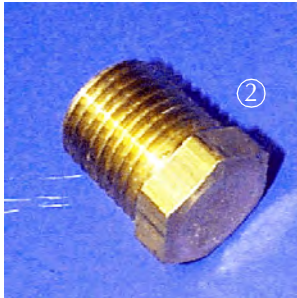
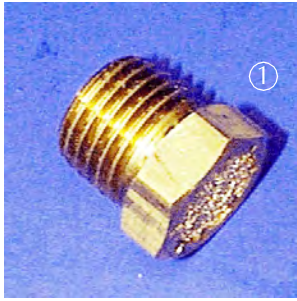

Install the Vents and Plugs

Tools required:

- ❑ 14 mm wrench
- ❑ Loctite PST 567 pipe sealant, included in maintenance kit

Locate the following parts:

- ① Breather Vent, PTS03001UNIV and PTS03003UNIV, 1 required
- ② 1/4 NPT brass plug, PTS03001UNIV and PTS03003UNIV, 1 required
PTS03101UNIV and PTS03103UNIV, 2 required

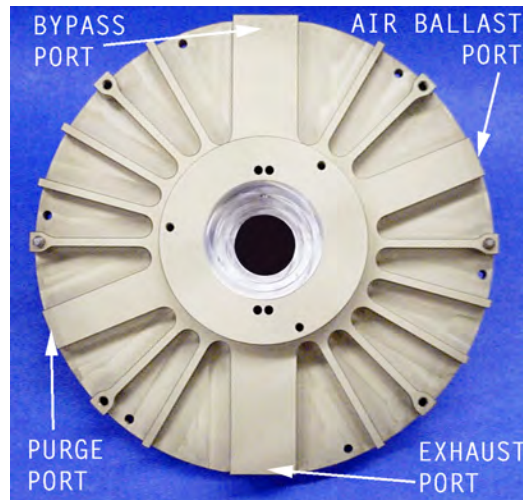
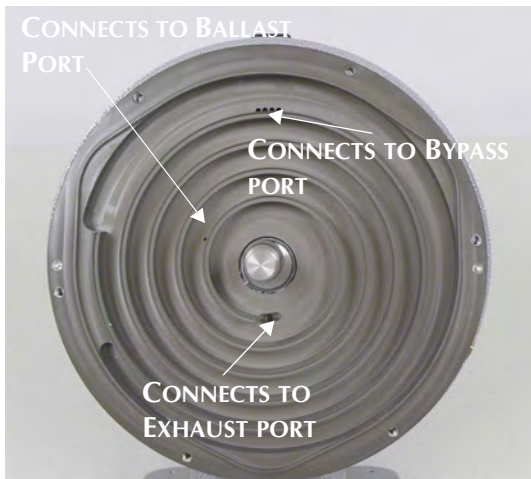

Inboard Housing Port Definition

Inboard Housing Assembly (continued)

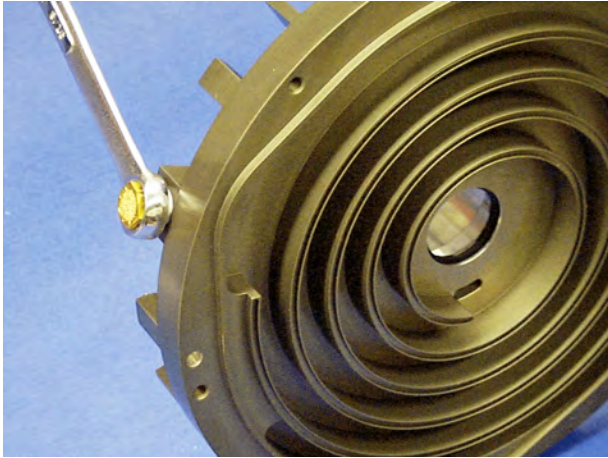

PTS03001UNIV and PTS03003UNIV *only*

1. Apply a small amount of Loctite PST 567 pipe sealant to the first few threads of breather vent.
2. Insert and tighten the breather vent into the air ballast port.

PTS03101UNIV and PTS03103UNIV *only*

1. Apply a small amount of Loctite PST 567 pipe sealant to the first few threads of 1/4 NPT brass plug.
2. Insert the plug into the air ballast port and tighten.

NOTE



The photo shows a breather vent being installed into the air ballast port.

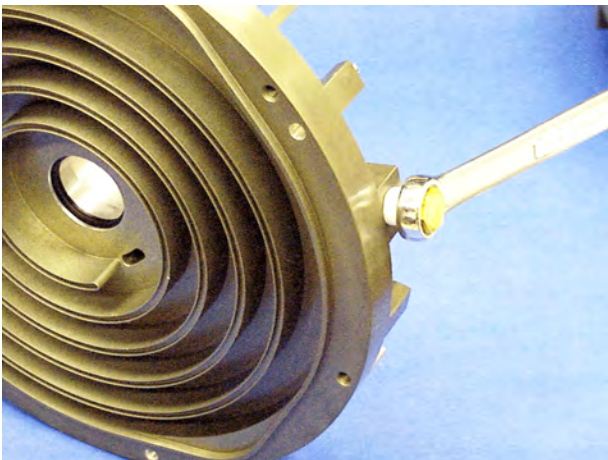

3. Apply a small amount of Loctite PST 567 pipe sealant to the first few threads of the second 1/4 NPT brass plug.
4. Insert the plug into the bearing purge port and tighten.

Inboard Housing Assembly (continued)

Exhaust Port Reassembly

PTS03001UNIV and PTS03003UNIV only

Tools required:

- ❑ Right angle snap ring pliers
- ❑ Krytox GPL 224 grease

Locate the following parts:

- ① Spring, large
- ② Plunger guide
- ③ Spring, small
- ④ Check valve assembly
- ⑤ Snap Ring

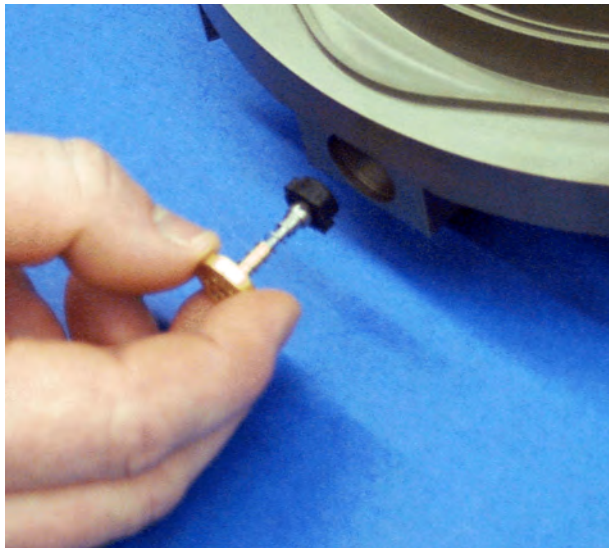
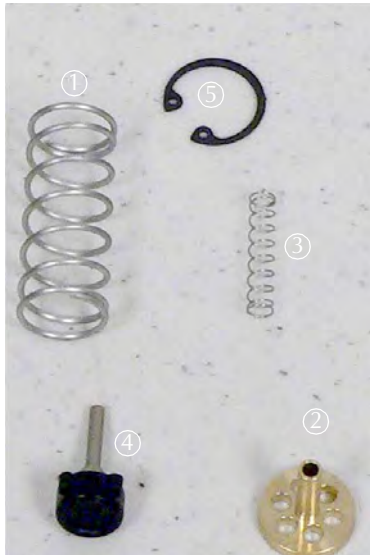

PTS03001UNIV and PTS03003UNIV only

1. Place the small spring onto the plunger guide.
2. Place the check valve onto the plunger guide.
3. Insert the check valve assembly, check valve first, into the exhaust port on the inboard housing.
4. Observe the proper orientation as shown in photo on the left.

Inboard Housing Assembly (continued)

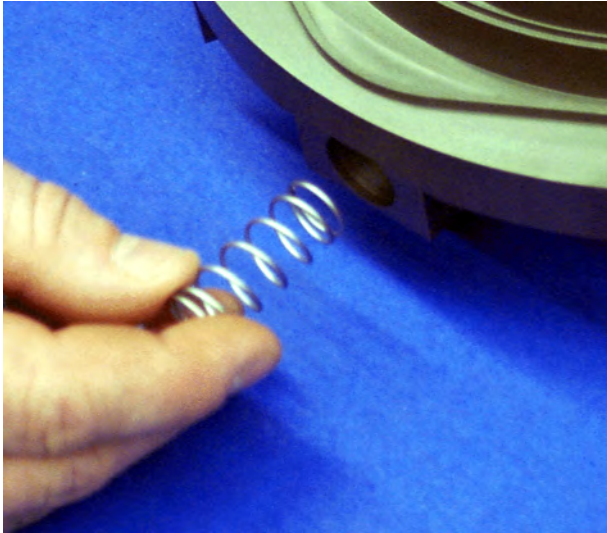

PTS03001UNIV and PTS03003UNIV only

- ❑ Insert the larger spring into the exhaust port, pushing against the plunger guide.

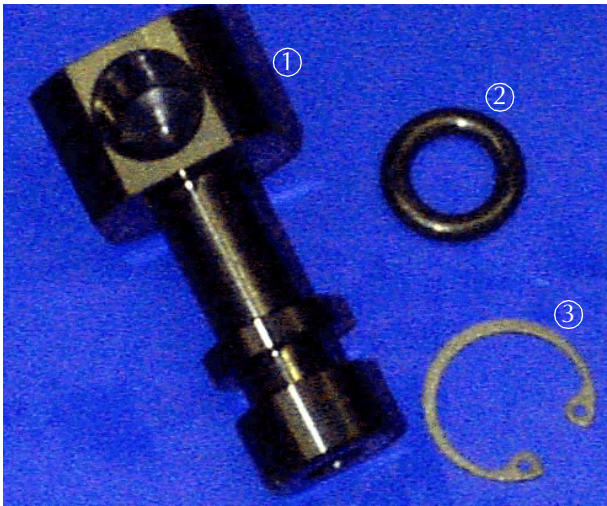

Tools required:

- ❑ Right angle snap ring pliers
- ❑ Krytox GPL 224 grease

Locate the following parts:

- ① Exhaust fitting
- ② O-ring, 2-205, included in maintenance kit
- ③ Snap ring



1. Lightly grease the O-ring, then install it in the groove on exhaust fitting.
2. Place the snap ring on the exhaust fitting. The snap ring must be bent slightly to fit around the exhaust fitting.

Inboard Housing Assembly (continued)

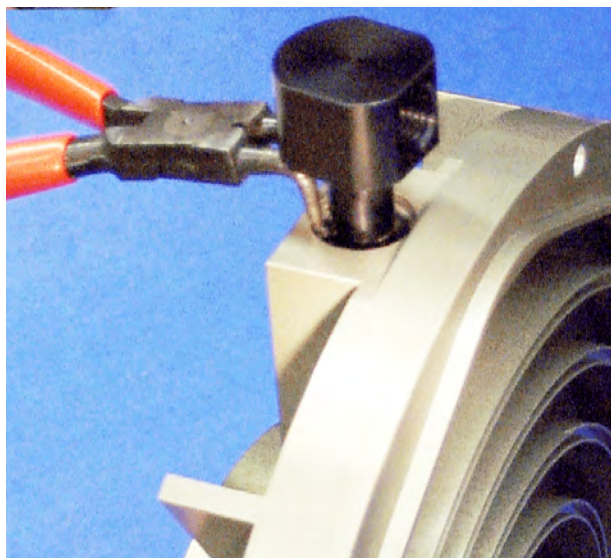

3. Push the exhaust fitting into the exhaust port and against the spring.
4. Secure it by inserting the snap ring into the groove in the exhaust port.



Bypass Port Reassembly

Tools required:

- ❑ Hemostat Pliers
- ❑ Right angle snap ring pliers
- ❑ Krytox GPL 224 grease

Locate the following parts:

- ① Check valve spacer
- ② Plunger guide
- ③ Check valve assembly (2)
- ④ Spring, small (2)
- ⑤ Spring, large
- ⑥ O-rings, 2-111 (3), included in maintenance kit.
- ⑦ Check valve plug
- ⑧ Snap ring
- ⑨ Bypass Cover

Inboard Housing Assembly (continued)



5. Place the two small springs onto the plunger guide.
6. Place one check valve into the long end of the plunger guide.
7. Insert the check valve assembly, check valve first, into the bypass port on the inboard housing.
8. Observe the proper orientation as shown in the photo on the left.

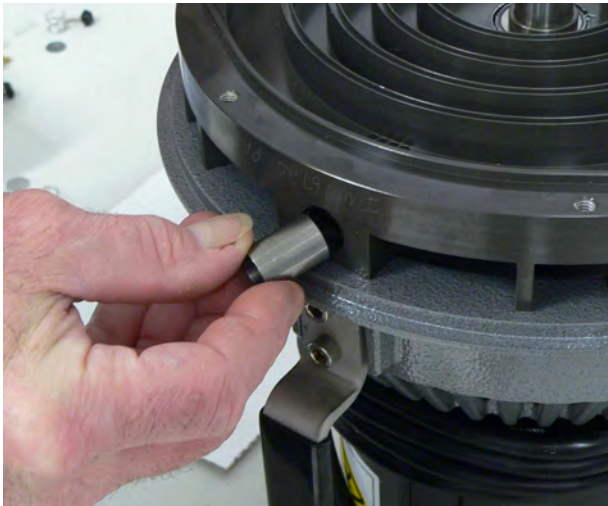

9. Insert the check valve spacer into the bypass port, pushing against the plunger guide.

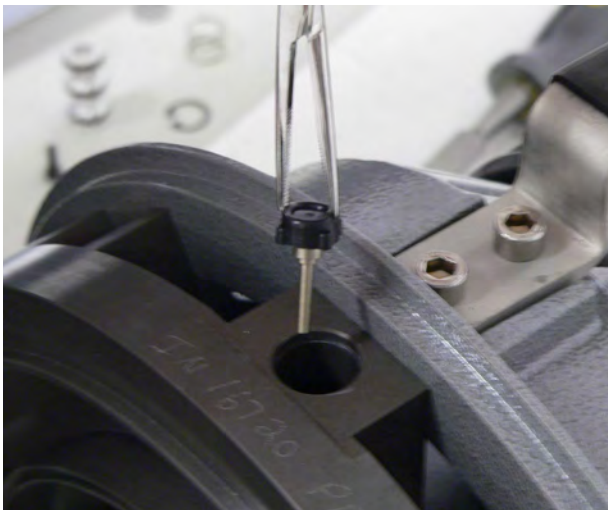

10. Using the Hemostat pliers, insert the other check valve into the short end of the plunger guide.

Inboard Housing Assembly (continued)

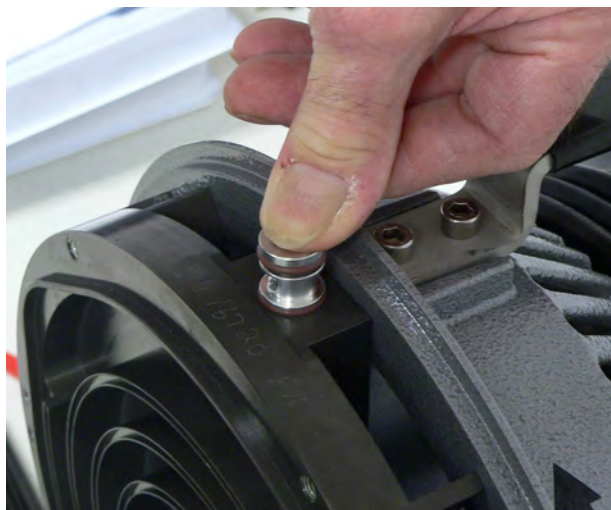

11. Lightly grease the three O-rings and install them in the grooves on the check valve plug.
12. Insert the check valve plug into bypass port against the check valve spacer.



13. Insert the large spring into the bypass port against the bypass plug.

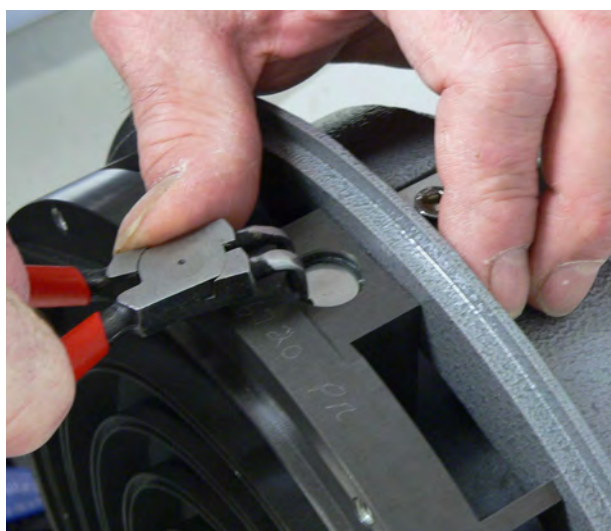

14. Insert the bypass cover onto the spring on the bypass port and compress the large spring using the bypass cover.
15. Secure the bypass cover by inserting the snap ring into the bypass port groove.

TriScroll 300 Dry Scroll Vacuum Pump

This page intentionally left blank.

Orbiting Plate Assembly

Orbiting Plate Exploded View

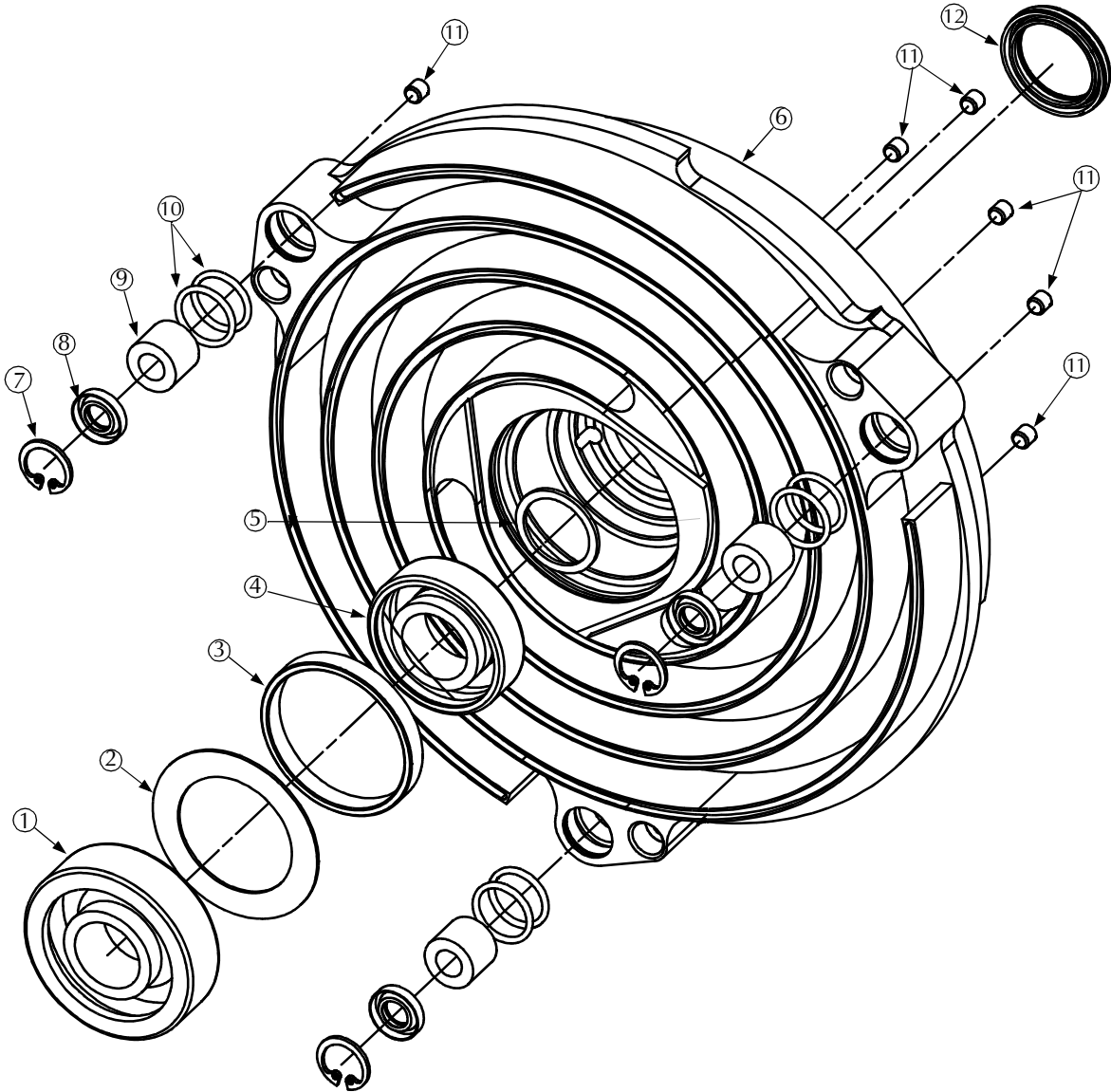

TriScroll 300 Dry Scroll Vacuum Pump

Callout	Part Number	Description	Quantity
①	MK*	7304BE Bearing	1
②	S4729001	VDS4- Orbiting Spacer	1
③	MK*	VDS4- Nylon Sleeve	1
④	MK*	6004VRLD Bearing	1
⑤	S4758001	Wave Washer - Nested	1
⑥	NSS*	VDS4- Center Orbiting Plate	1
⑦	NSS*	DIN472-0150 Snap Ring	3
⑧	MK*	Shaft Seal, 8x15x3	3
⑨	MK*	NK 8/12 Needle Bearing	3
⑩	MK*	2-016 Viton O-ring	6
⑪	NSS*	M5x5 Set Screw	6
⑫	MK*	Shaft Seal 24x32x4	1

MK = Included in major maintenance kit

TSK = Included in tip seal kit

NSS = Not sold separately

Orbiting Plate Assembly

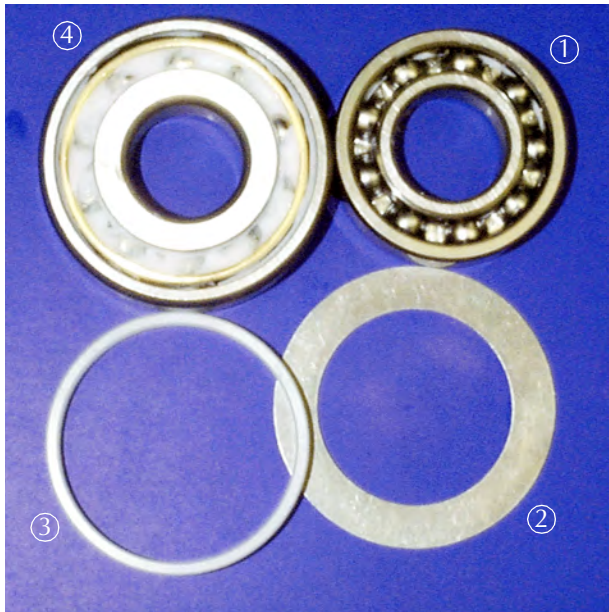

Install the Bearing Assembly

Tools required:

- ❑ Heat resistant gloves
- ❑ Orbiting plate fixture

Locate the following parts:

- ① 6004VRLD bearing, included in maintenance kit
- ② Nylon sleeve, included in maintenance kit
- ③ Orbiting spacer
- ④ 7304BE bearing, included in maintenance kit

Orbiting plate (not shown in photo)

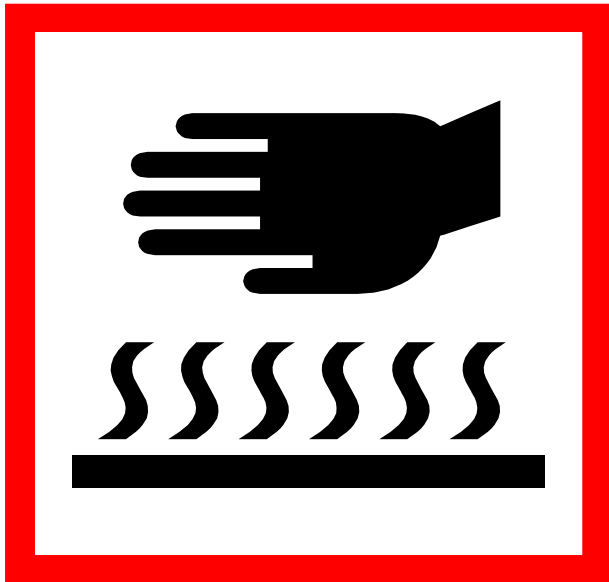

WARNING *This step requires the use of heat resistant gloves. Do not proceed without them!*



1. Heat the orbiting plate for a minimum of 1 hour in 350 °F oven. While the orbiting plate is heating, prepare the bearing fixture.

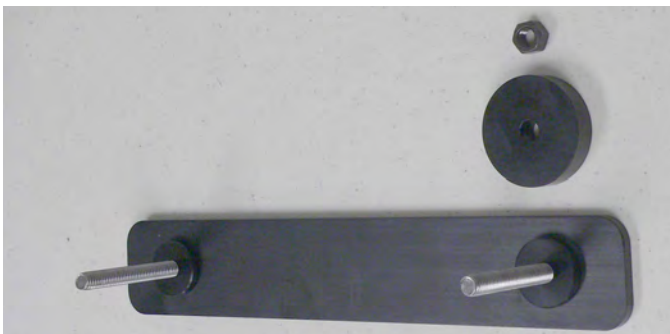

The posts of the orbiting plate bearing fixture have two different sized bottom disks. Use the end that has the larger of the bottom disks.

2. Remove the nut and large washer from the post with the larger bottom disk from the fixture in preparation for clamping the orbiting plate assembly.

Orbiting Plate Assembly (continued)

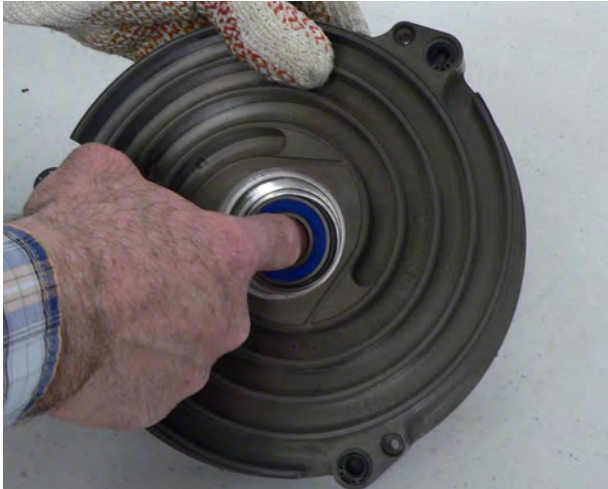

WARNING *Assembly is hot, use heat resistant gloves.*



3. Immediately after removing the orbiting plate from the oven, insert the 60004VRLD bearing. The bearing can be installed in either direction.



WARNING *Assembly is hot, use heat resistant gloves.*



4. Immediately, and while the orbiting plate is still hot, drop the nylon sleeve into bore and around the 6004VRLD bearing.



5. Drop the orbiting spacer on top of the nylon sleeve.

Orbiting Plate Assembly (continued)

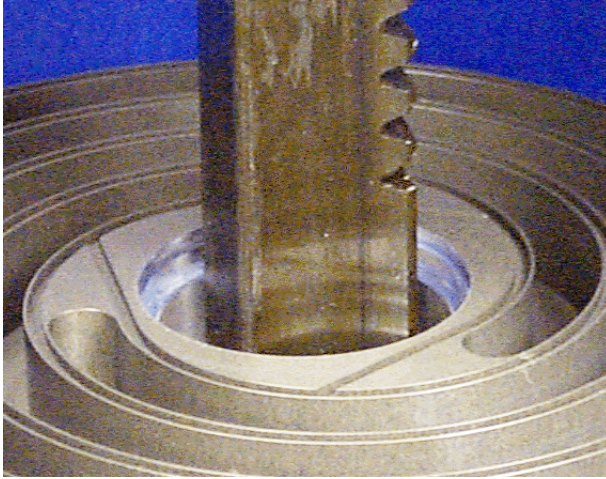

WARNING *Assembly is hot, use heat resistant gloves.*



6. Using an arbor press, press against the orbiting spacer until it is flush with the open end of the J9104P bearing.

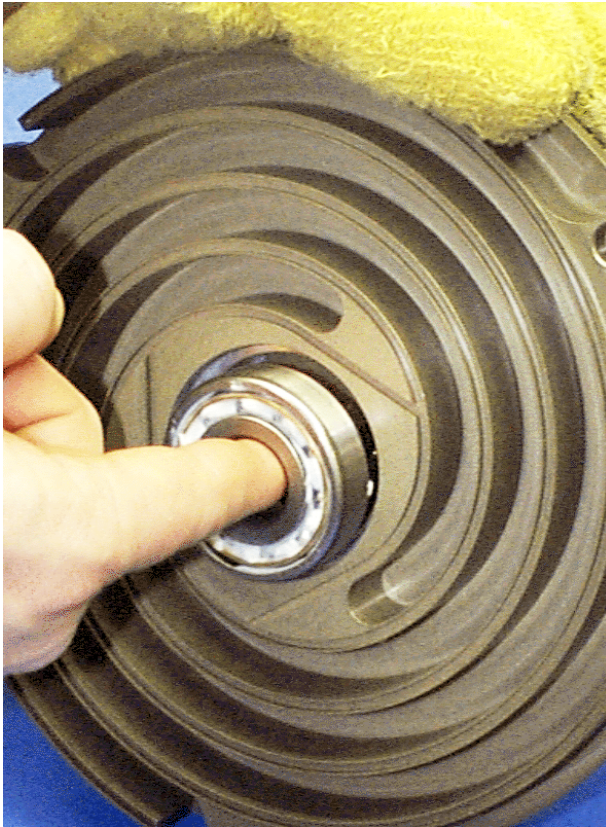

WARNING *Assembly is hot, use heat resistant gloves.*



7. Immediately, while orbiting plate is still hot, insert the 7304BE bearing into the bore and against the orbiting spacer.

Observe Proper Orientation



↓
Toward Bore

Orbiting Plate Assembly (continued)



8. Immediately, while the orbiting plate is still hot, place the orbiting plate onto the post of the orbiting plate fixture that has the larger bottom disk.
9. Place the large washer and the locking nut onto the post and tighten the entire assembly.

WARNING *Assembly is hot, use heat resistant gloves.*



10. Allow the orbiting plate to air cool completely.
11. Once it is cooled, remove the orbiting plate from the orbiting plate fixture.
12. Replace the large washer and tighten the nut onto the orbiting plate fixture.

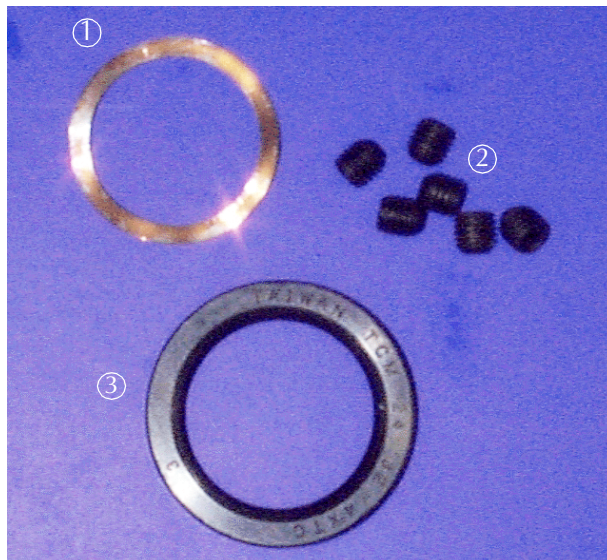

Install the Wave Washer and Shaft Seal

Tools required:

- Allen wrench
- Arbor press
- Seal installation tool
- Krytox GPL 224 grease
- Loctite 242

Locate the following parts:

- ① Wave washer - nested
- ② M5x5 set screw (6)
- ③ Shaft seal, 24x32x4, included in maintenance kit

Orbiting Plate Assembly (continued)

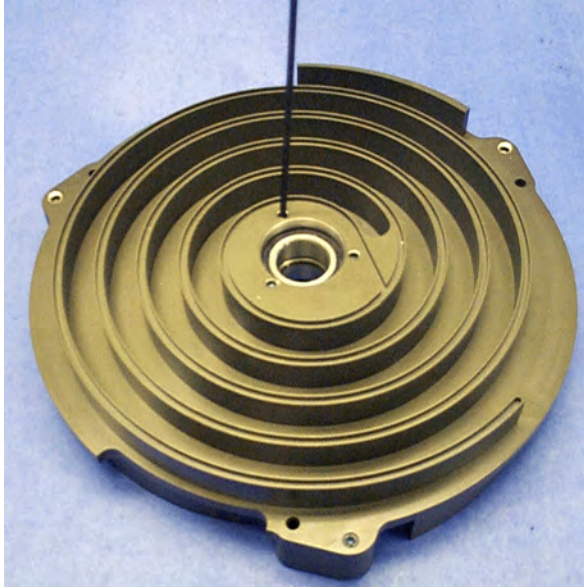

1. Apply a small amount of Loctite 242 to the lower threads of the six M5x5 screws, then install one screw into each threaded hole in the orbiting plate.
2. Tighten the screws until they are slightly below the surface.



3. Install the wave washer into the orbiting plate.

Orbiting Plate Assembly (continued)

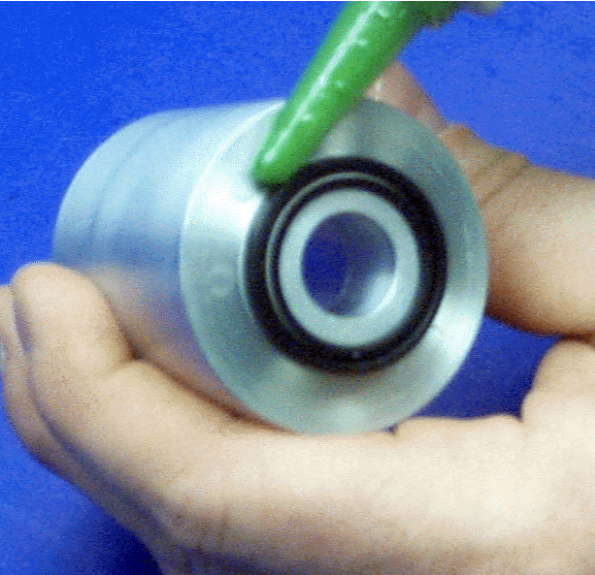

4. Apply a thin film of Loctite 242 to the outer edge of the shaft seal.

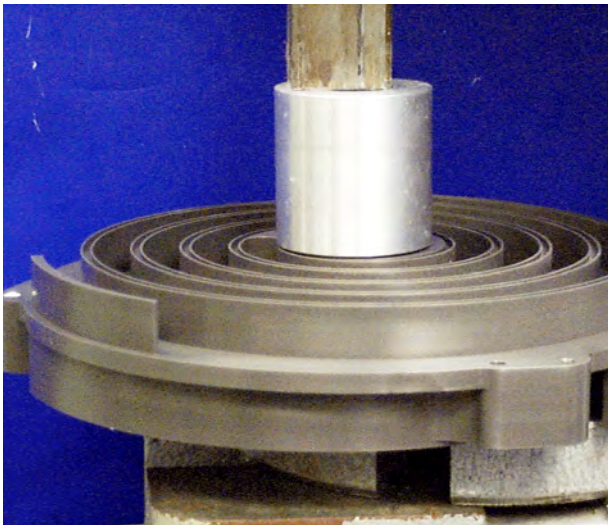

5. Place the shaft seal onto the shaft seal installation tool.
6. Using the shaft seal installation tool, press the shaft seal into the orbiting plate.

Observe Proper Orientation

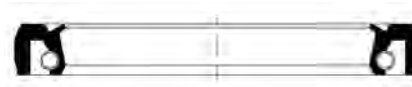

Toward Bore

7. Apply Krytox GPL 224 to the inner diameter of the seal between the lips.

Orbiting Plate Assembly (continued)

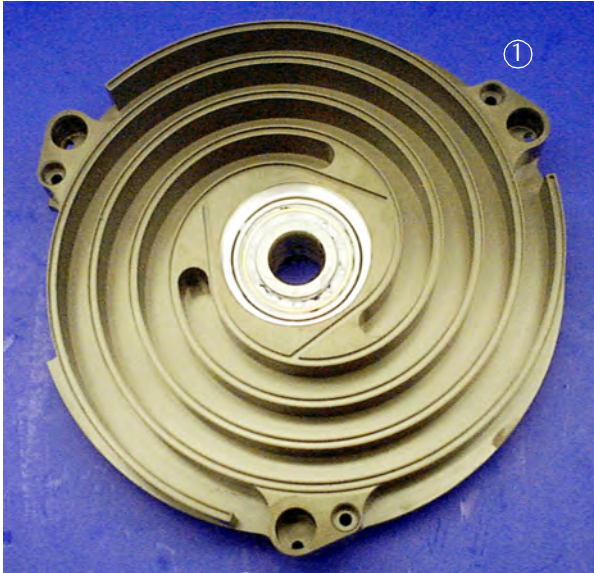

Install the Needle Bearings

Tools required:

- ❑ Right angled snap ring pliers
- ❑ Krytox GPL 224 grease

Locate the following part in the photo on the left:

- ① Orbiting plate



Locate the following parts in the photo on the left:

- ① Snap rings (3)
- ② O-rings, 2-016 (6), included in maintenance kit
- ③ Needle bearing (3), included in maintenance kit
- ④ Shaft seals, 8x15x3 (3), included in maintenance kit

Orbiting Plate Assembly (continued)



1. Lightly grease the O-rings, then insert them into the two grooves in each of three sync crank bearing bores in the orbiting plate.
2. Push one needle bearing into each bearing bore.

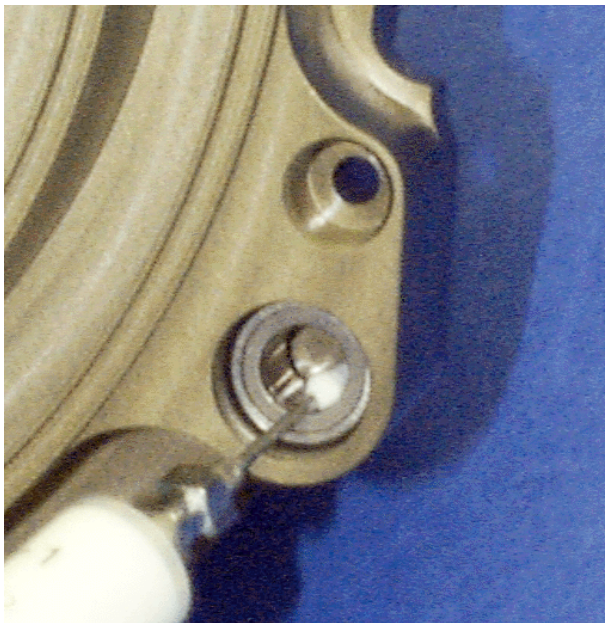

3. Squeeze a 1/4" diameter dot of Krytox into each of the three needle bearings.
4. Smear grease over all the needles.

Orbiting Plate Assembly (continued)



5. Coat the lips of the three shaft seals with grease.
6. Insert one shaft seal into each bore against the needle bearing.

Observe Proper Orientation

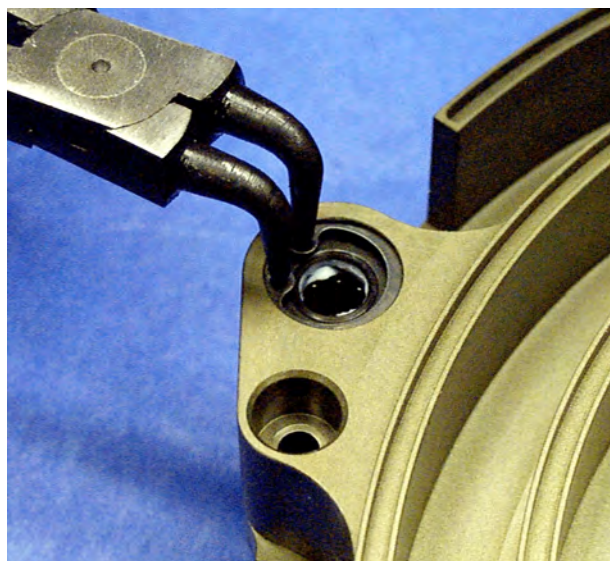
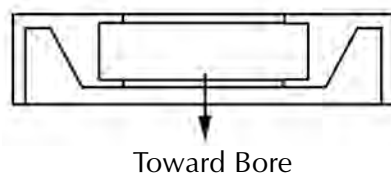

7. Secure each needle bearing and seal by inserting a snap ring into each bearing bore groove.

TriScroll 300 Dry Scroll Vacuum Pump

This page intentionally left blank.

TriScroll 300 Assembly

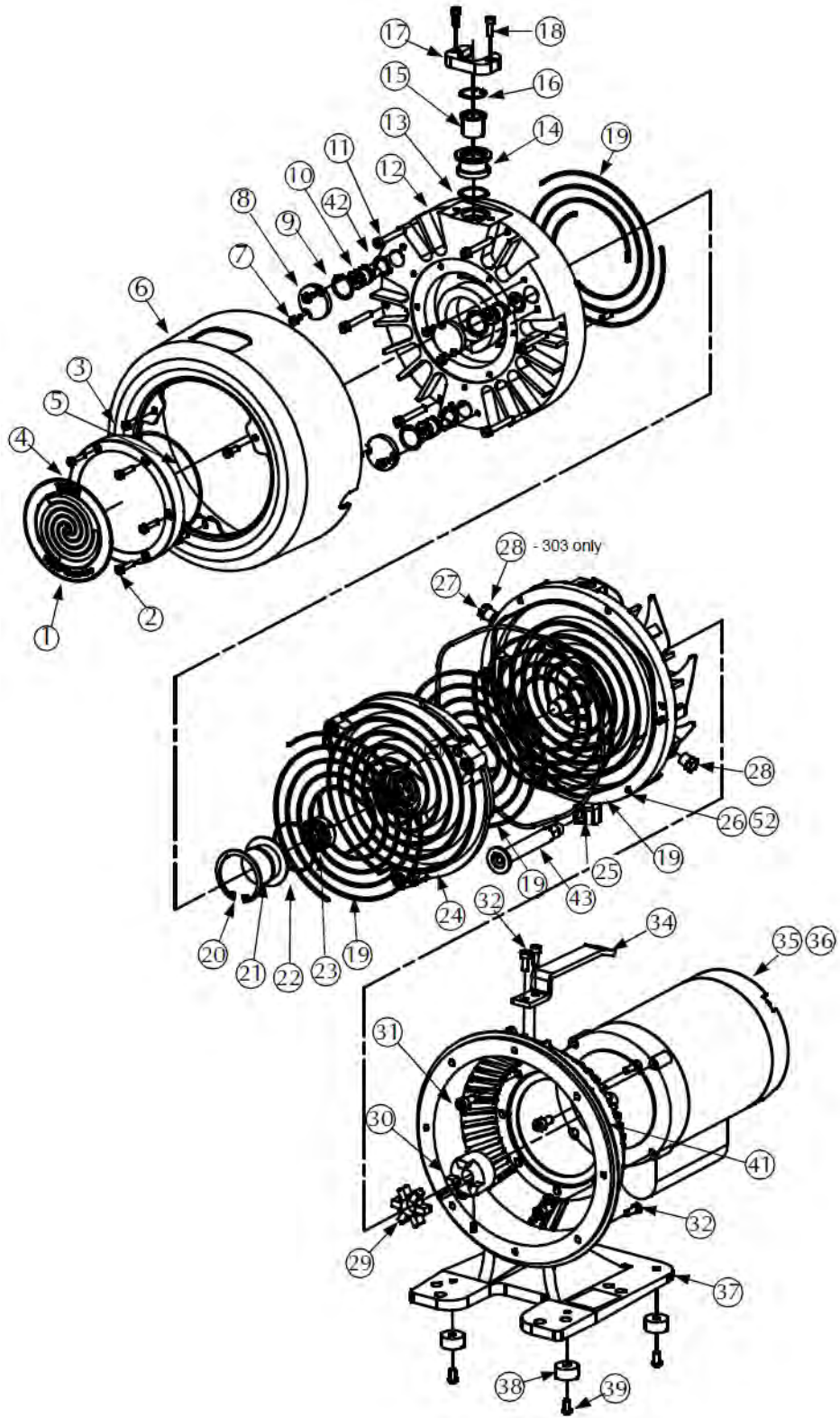

TriScroll 300 Dry Scroll Vacuum Pump

TriScroll 300 Exploded View

Callout	Part Number	Description	Quantity			
			PTS03103UNIV	PTS03101UNIV	PTS03003UNIV	PTS03001UNIV
①	S4744001	TriScroll Pump Front Label	1	1	1	1
②	NSS*	M5x22 SHCS	6	6	6	6
③	NSS*	M5x10 SHCS, Shoulder Screw	3	3	3	3
④	S4703001	VDS4 - Outboard Cover	1	1	1	1
⑤	MK*	2-157 Viton O-ring	1	1	1	1
⑥	S4705001	VDS4 - Cowling	1	1	1	1
⑦	NSS*	M5x10 SHCS	6	6	6	6
⑧	S4717001	VDS4 - Sync Crank Cover	3	3	3	3
⑨	MK*	2-118 Viton O-ring	3	3	3	3
⑩	MK*	VDS4 - Sync Crank Assembly	3	3	3	3
⑪	NSS*	M6x45 SHCS	6	6	6	6
⑫	NSS*	VDS4 - Outboard Housing	1	1	1	1
⑬	MK*	2-121 Viton O-ring	1	1	1	1
⑭	S4709001	VDS4 - NW25 Intake Fitting	1	1	1	1
⑮	S4724001	VDS4 - Intake Screen	1	1	1	1
⑯	NSS*	N5000-106 Snap Ring	1	1	1	1
⑰	S4708001	VDS4- Intake Clamp	1	1	1	1

MK = Included in major maintenance kit

TSK = Included in tip seal kit

NSS = Not sold separately

TriScroll 300 Dry Scroll Vacuum Pump

Callout	Part Number	Description	Quantity			
			PTS03103UNIV	PTS03101UNIV	PTS03003UNIV	PTS03001UNIV
⑱	NSS*	M5x16 SHCS	2	2	2	2
⑲	MK* & TSK*	VDS4 - Tip Seal	1	1	1	1
⑳	NSS*	N5000-225 Snap Ring	1	1	1	1
㉑	S4719001	VDS4- Orbiting Cup	1	1	1	1
㉒	MK* & TSK*	2-137 Viton O-ring	1	1	1	1
㉓	617919032	Spieth Locknut	1	1	1	1
㉔	NSS*	VDS4- Orbiting Plate Assembly	1	1	1	1
㉕	MK* & TSK*	2-269 Viton O-ring	1	1	1	1
㉖	NSS*	TS300 Inboard Assembly	-	-	1	1
㉗	642971040	Breather Vent	-	-	1	1
㉘	NSS*	1/4 Brass Plug	2	2	1	1
㉙	670086120	Spider, L075 Open	1	1	1	1
㉚	622471058	Coupling, L075 W/15 mm Key	1	1	1	1
㉛	NSS*	M8x16 SHCS	4	4	4	4
㉜	NSS*	M6x16 SHCS	6	6	6	6
㉝	S4721001	VDS4- Handle	1	1	1	1
㉞	S4743001	VDS4- 3/4 HP Single Phase Motor	-	1	-	1
㉟	S4739002	VDS4-3/4 HP 3 Phase Motor	1	-	1	-
㊱	S4704001	VDS4- Transition Frame	1	1	1	1

MK = Included in major maintenance kit

TSK = Included in tip seal kit

NSS = Not sold separately

TriScroll 300 Dry Scroll Vacuum Pump

Callout	Part Number	Description	Quantity			
			PTS03103UNIV	PTS03101UNIV	PTS03003UNIV	PTS03001UNIV
③⑧	648099055	Rubber Foot	4	4	4	4
③⑨	NSS*	M6x12 Socket Head Button Screw	4	4	4	4
④①	NSS*	Arrow Decal	1	1	1	1
④②	660288087	SSB-0087, Wave Spring	3	3	3	3
④③	S4707002	VDS4- NW16 Pipe Fitting	-	1	1	1
⑤②	NSS*	TS310 Inboard Assembly	1	1	-	-

MK = Included in major maintenance kit

TSK = Included in tip seal kit

NSS = Not sold separately

Final Assembly

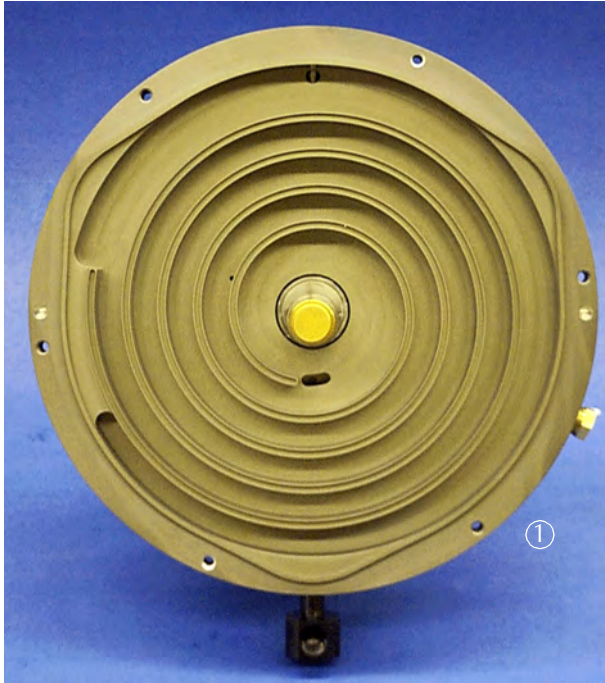

Tools required:

- Allen wrench

Locate the following items:

- ① Inboard housing assembly
- ② Spider coupling
- ③ M6x16 screws (4)

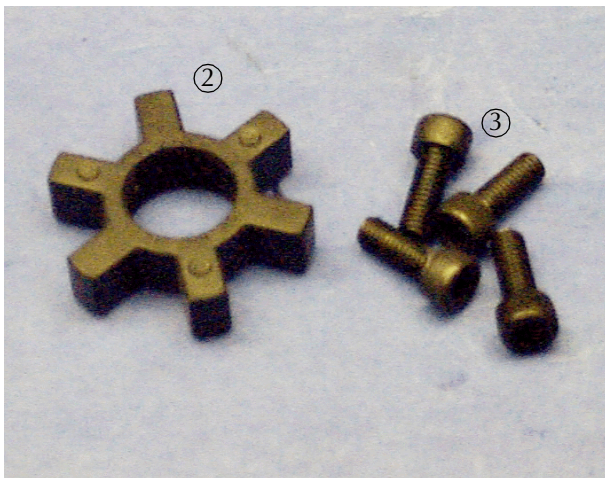

Final Assembly (continued)



1. Insert the spider into the motor coupling.



2. Install the inboard assembly into the TriScroll frame, aligning the fingers on the fan assembly with the fingers on the coupling.

Ensure that the dowel pins fit properly on the mating holes in frame.

NOTE



Exhaust fitting located in the downward position.

Final Assembly (continued)

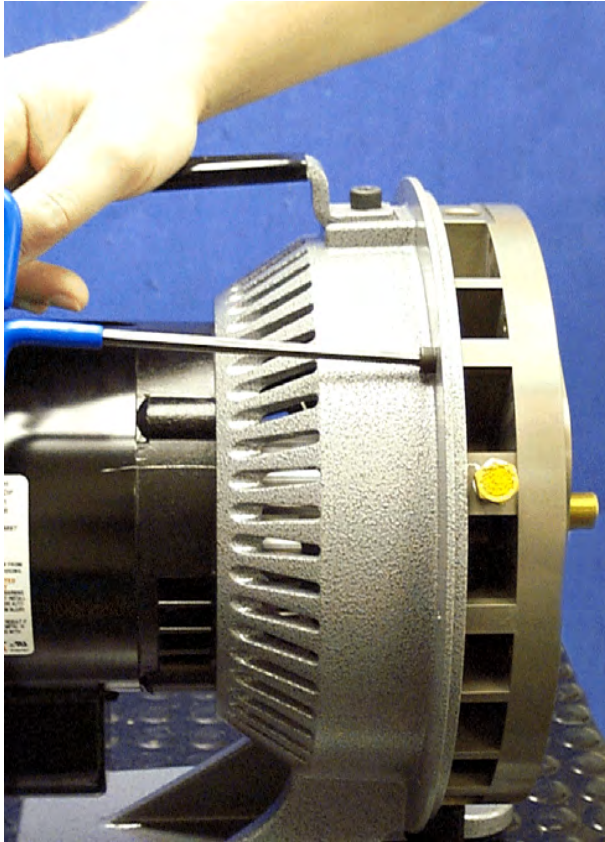

3. Secure the inboard assembly to the frame with the four M6x16 screws.

Final Assembly (continued)

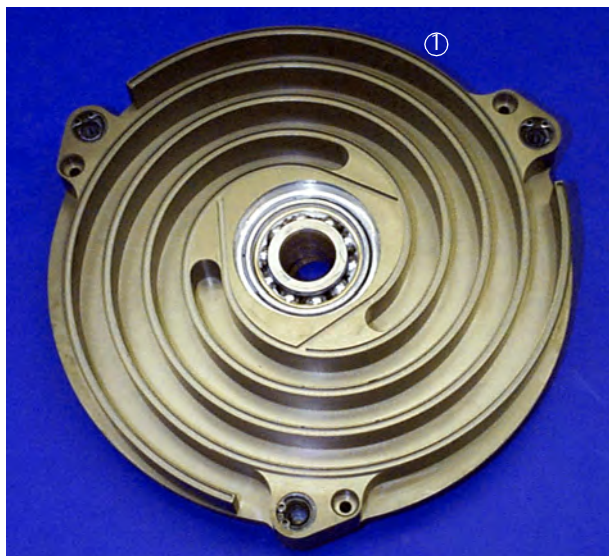

Install the Orbiting Plate

Tool required:

- Locking nut wrench
- Snap ring pliers
- Allen wrench
- Depth Gauge
- Krytox GPL 224 grease

Locate the following parts:

- Orbiting plate assembly



Locate the following parts:

- ① O-ring, large, 2-269, included in maintenance kit
- ② Orbiting cup
- ③ Locking nut
- ④ O-ring, small, 2-137, included in maintenance kit
- ⑤ Snap ring
- ⑥ Tip seals, included in maintenance kit

Final Assembly (continued)



1. Slide the orbiting plate assembly onto the crankshaft and into the inboard housing.

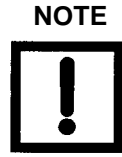

NOTE *The balance fin on the orbiting plate should be oriented in the downward position when sliding the orbiting plate onto the crankshaft and into the inboard housing.*

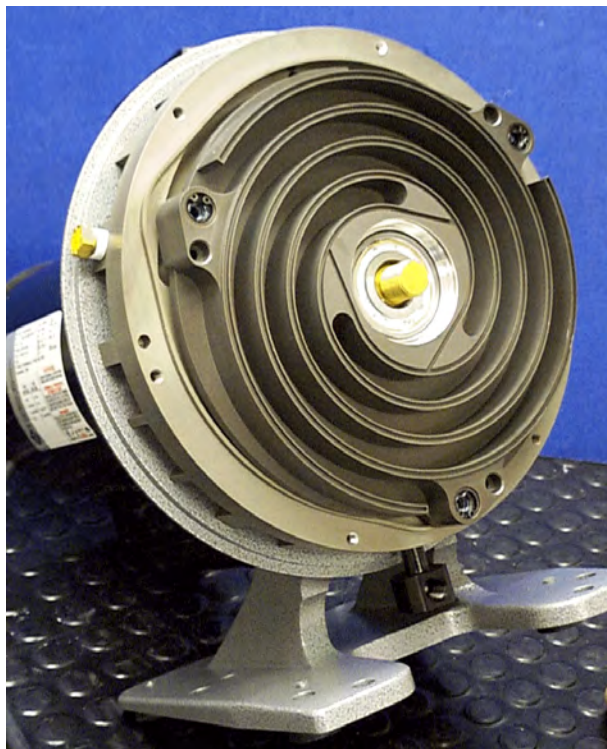

Final Assembly (continued)

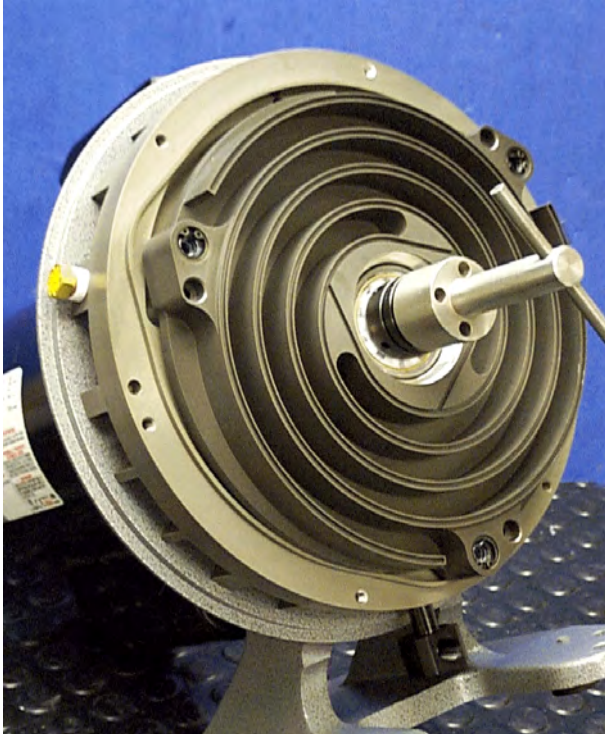

2. Remove the four M4x12 locking screws from the locking nut.
3. Secure the orbiting plate with the locking nut.
4. Tighten snugly with locking nut wrench.

CAUTION *Do not overtighten.
Overtightening can cause
bearing damage.*

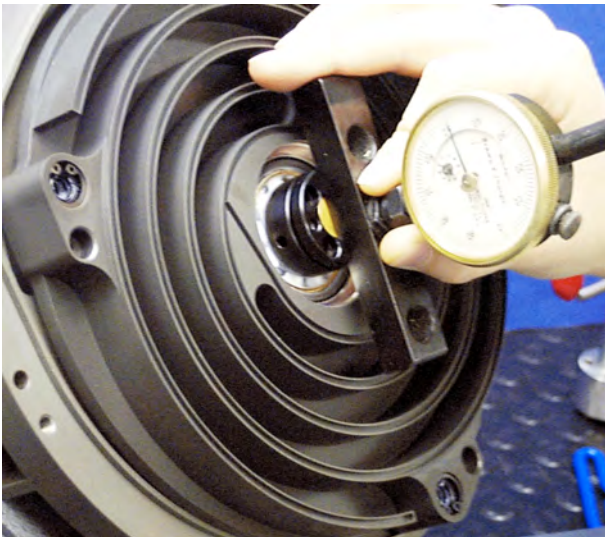

5. Measure the distance from the face of the locking nut to the crankshaft end using the depth gauge.
6. Note and record the distance.

Date _____
Distance _____

7. Disassemble the locking nut and orbiting plate assembly from the inboard assembly.

Final Assembly (continued)

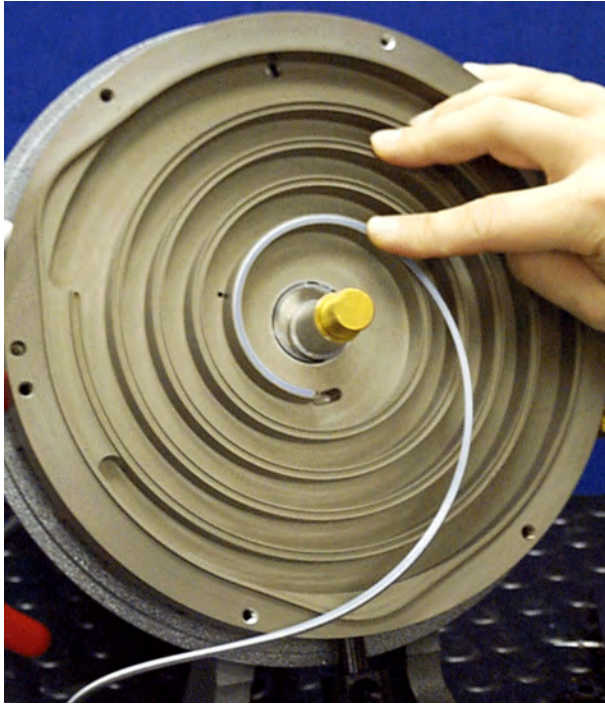

8. Insert the tip seal into the scroll tip groove on the inboard housing.



9. Cut the tip seal length so as to leave a 1/4" to 3/8" gap at the end of the groove.

Final Assembly (continued)

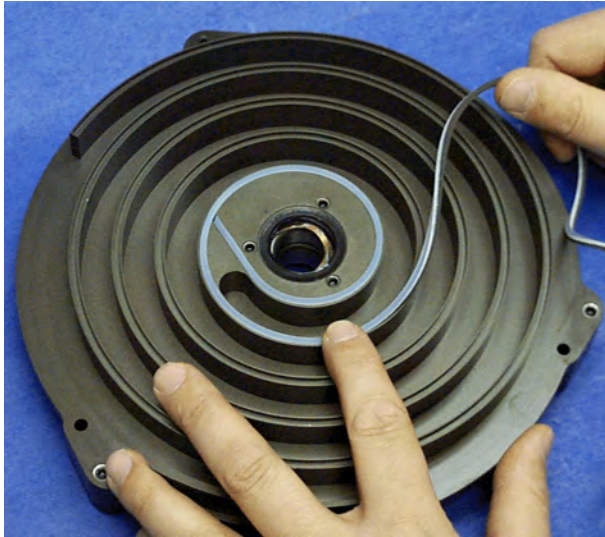

10. Insert the tip seal into the scroll tip grooves on the inboard side of orbiting plate.



11. Cut the tip seal length so as to leave a 1/4" to 3/8" gap at the end of the groove.

Final Assembly (continued)

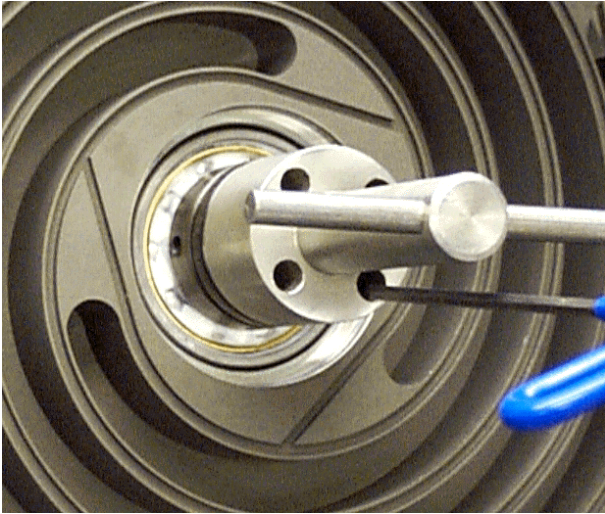

12. Repeat steps 1 through 3 to reassemble the orbiting plate assembly and locking nut on the inboard assembly.
13. Using the locking nut wrench, tighten the locking nut until the distance from the face of the locking nut to the crankshaft end equals the distance noted in step 6 on page 72, plus 0.007 inch.
14. Secure the locking nut by installing the four M4x12 locking screws.
15. Use the locking nut wrench to maintain the locking nut position while tightening the locking screws.

CAUTION *Make sure that the locking nut does not rotate relative to the crankshaft.*



16. Ensure that all four locking screws are tightened to at least 40 in-lb.
17. Insert a tip seal into each tip groove on orbiting plate.



Final Assembly (continued)

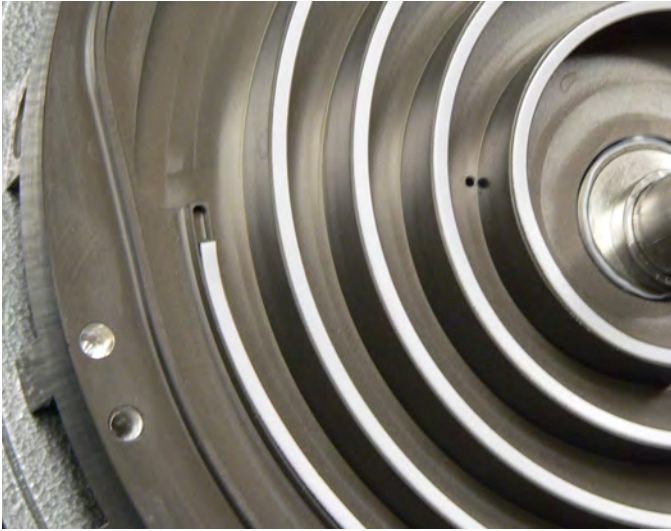

18. Cut the tip seal length so as to leave a 1/4" to 3/8" gap at the end of the groove.

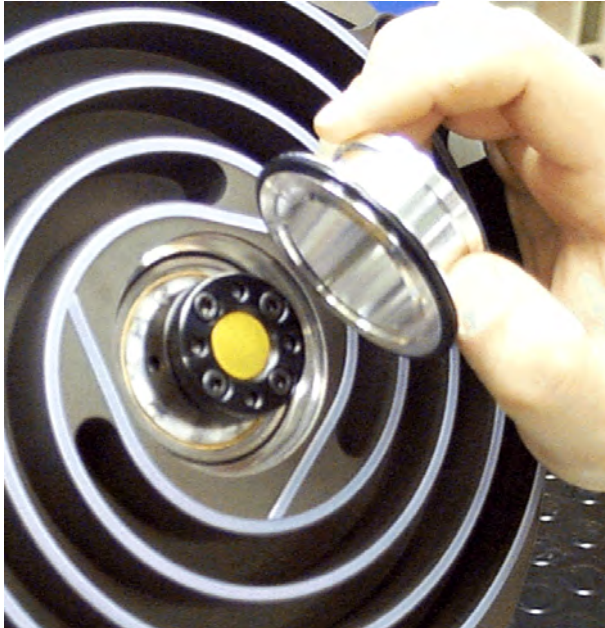

19. Lightly grease the O-ring and place it onto the orbiting cup.

Final Assembly (continued)

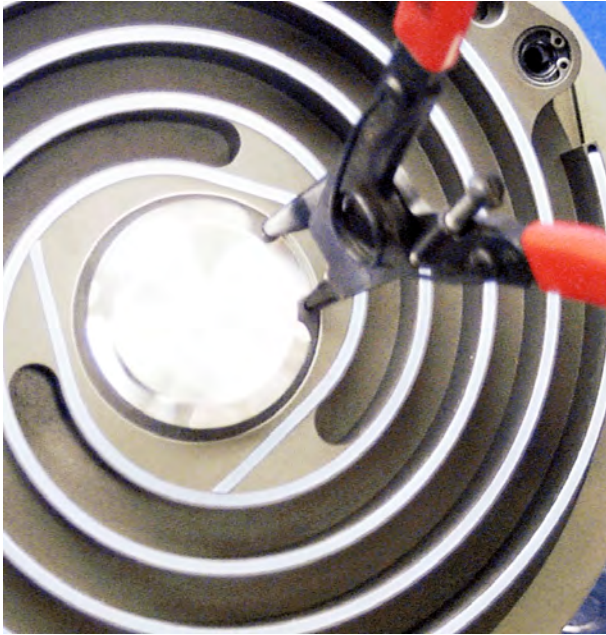

20. Insert the orbiting cup into the center of the orbiting plate.

21. Push the orbiting cup into place and hold it securely while engaging the snap ring

CAUTION



If the orbiting cup slips out prior to installing the snap ring, remove the orbiting cup, re-install the O-ring and re-insert the orbiting cup into the orbiting plate.

Use care not to shear the O-ring while pushing the orbiting cup into the orbiting plate.

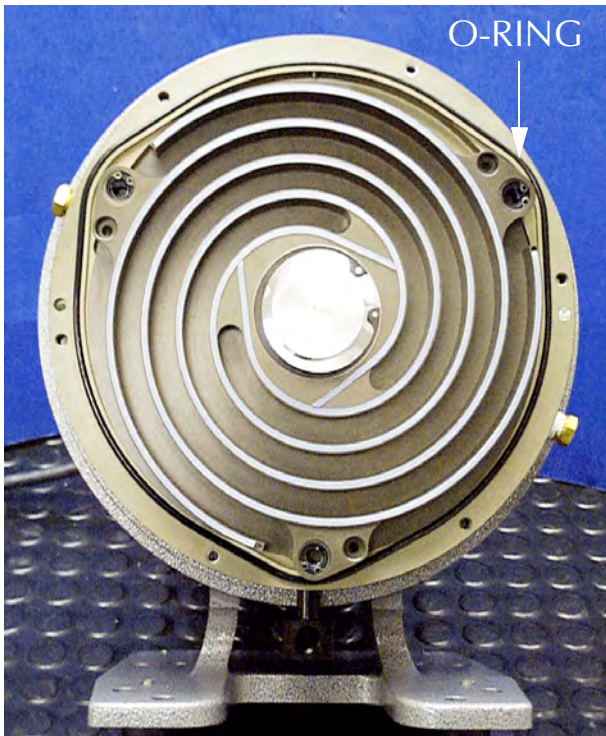

22. Lightly grease the large O-ring and install it around the lip of the inboard housing.

Final Assembly (continued)



Install the Outboard Housing

Tools required:

- ❑ Snap ring pliers
- ❑ Allen wrench
- ❑ Krytox GPL 224 grease

Locate the following items shown in the photo to the left:

- ① Intake fitting
- ② M5x16 screws (2)
- ③ O-ring, 2-121, included in maintenance kit
- ④ Intake clamp

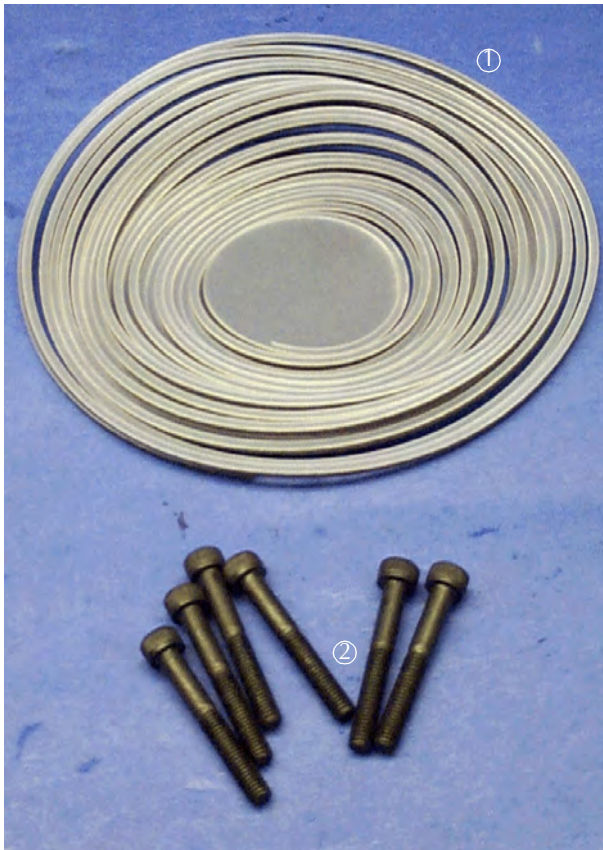

Locate the following items shown in the photo to the left:

- ① Tip seal, included in maintenance kit
- ② M6x45 screws (6)
 - Outboard housing (not shown in photo)

Final Assembly (continued)

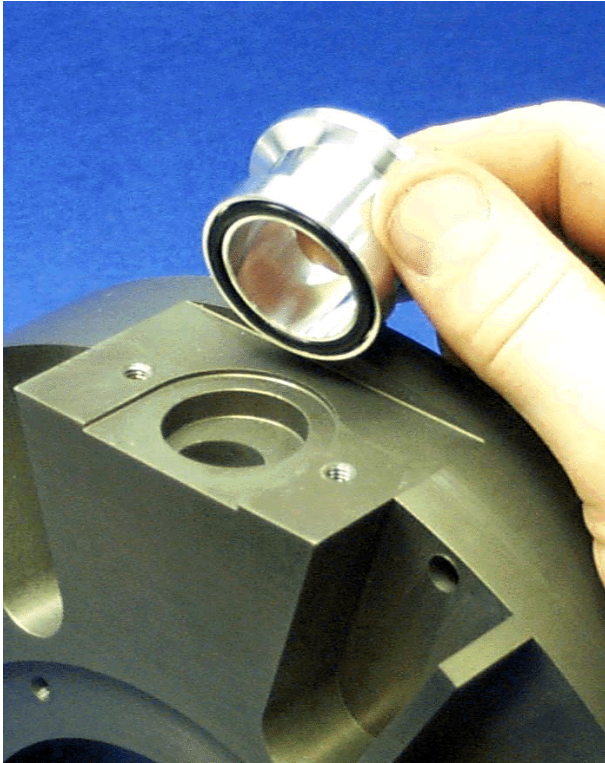

1. Lightly grease the O-ring and insert it in the groove on the intake fitting.



2. Place the intake fitting over the intake hole in the outboard housing.
3. Slide the intake clamp around the intake fitting.
4. Secure it with two M5x16 screws.
5. Tighten to 75 in-lb.

Final Assembly (continued)

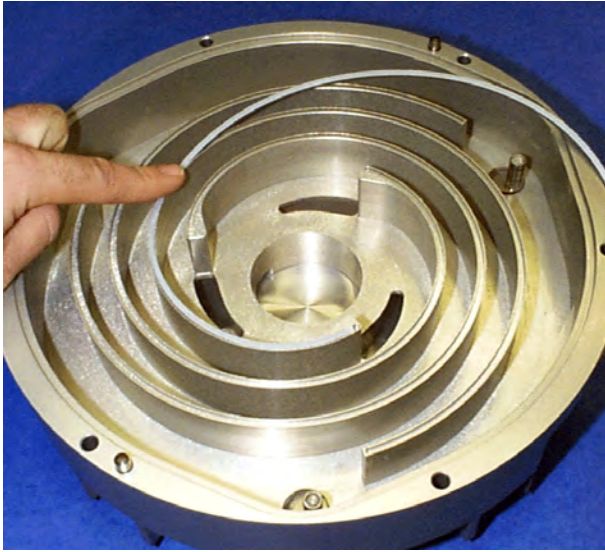

6. Insert a tip seal into each groove on the outboard housing.

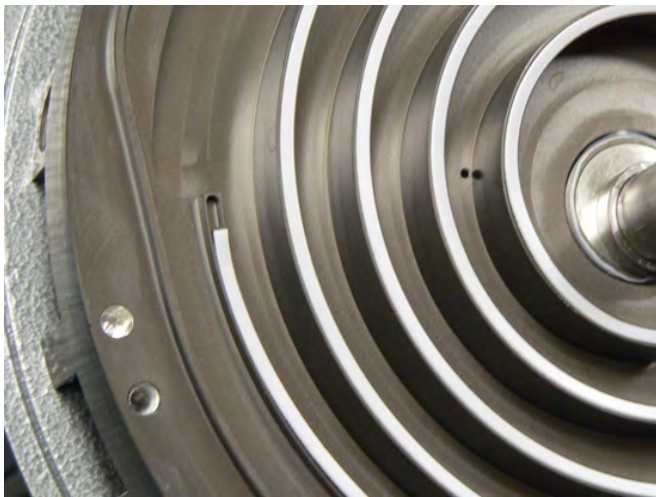

7. Cut the tip seal length so as to leave a 1/4" to 3/8" gap at the end of the groove.



8. Install the outboard housing over the orbiting plate and against the inboard housing, engaging the dowel pins.

Final Assembly (continued)

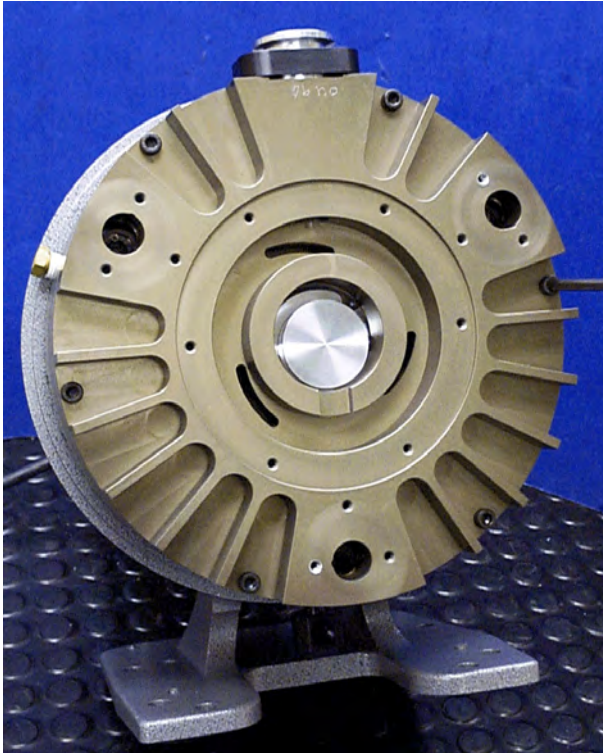

9. Secure the outboard housing to the inboard housing with the six M6x45 screws.
10. Tighten the screws sequentially in a diagonal pattern to 130 in-lb.

Final Assembly (continued)

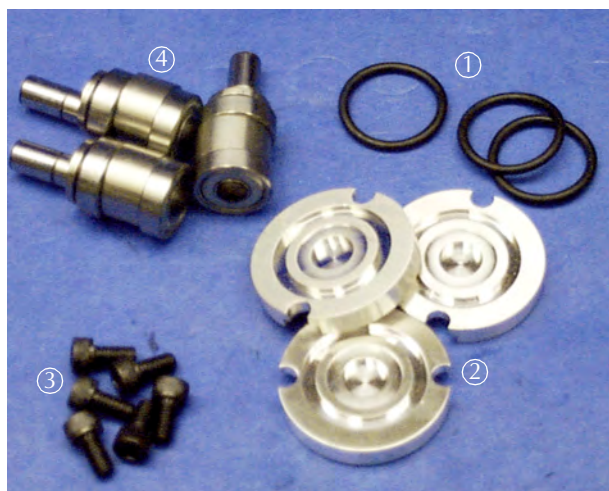

Install the Sync Crank into the Outboard Housing

Tools required:

- ❑ Allen wrench
- ❑ Krytox GPL 224 grease

Locate the following parts shown in the photo at the left:

- ① O-ring, 2-118 (3) included in maintenance kit
- ② Sync crank cover (3)
- ③ M5x10 screws (6)
- ④ Sync crank assembly (3) included in maintenance kit

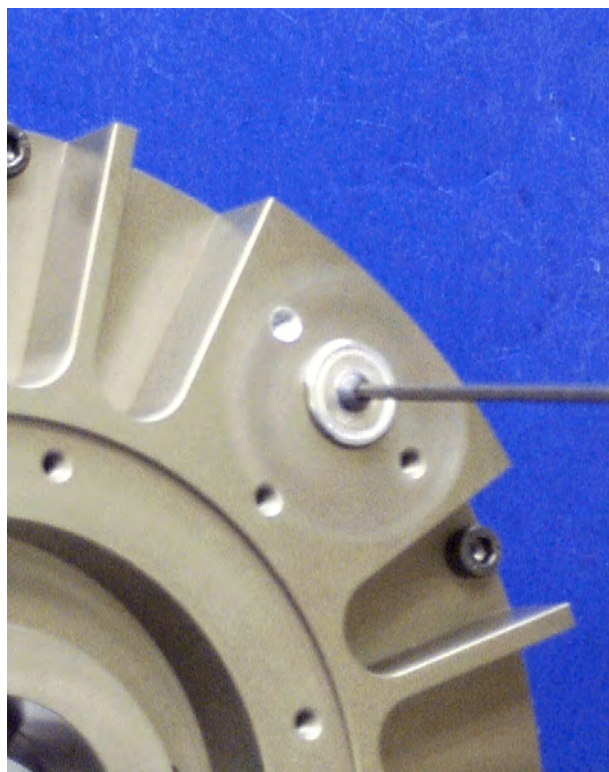

1. Insert one sync crank assembly into each of three bores in the outboard housing.
2. Ensure that the pin on the sync crank assembly end engages with the needle bearing in the orbiting plate.

Final Assembly (continued)

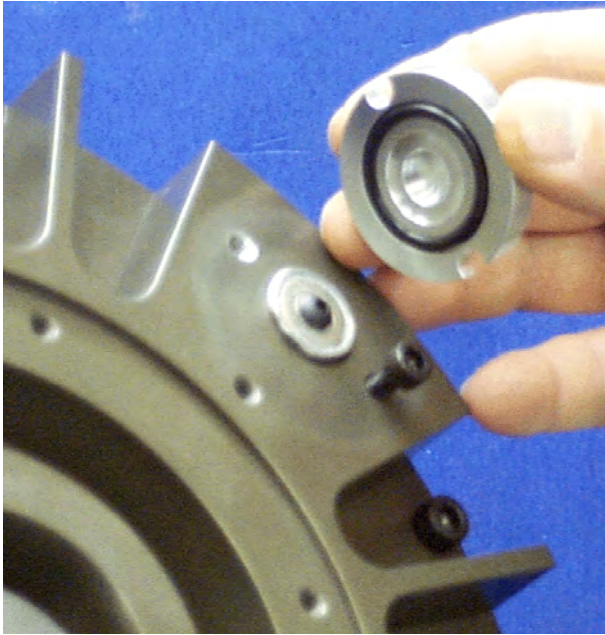

3. Lightly grease the three O-rings and insert them into the grooves on the three sync crank covers.

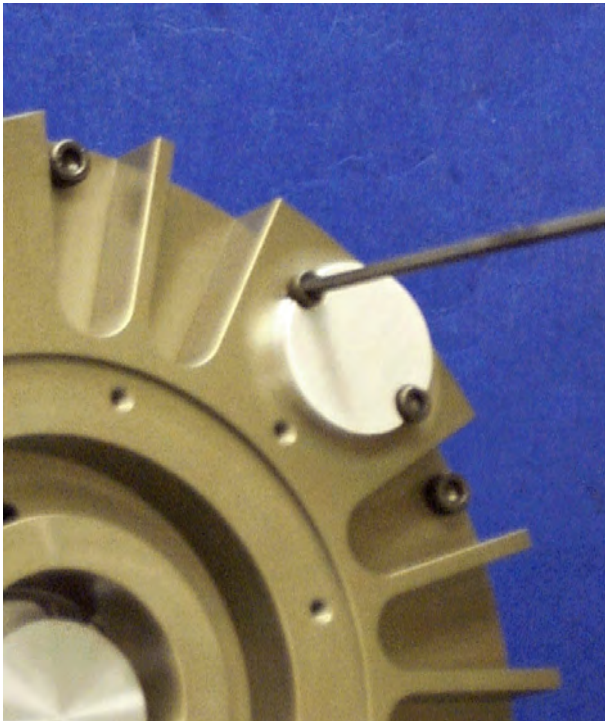

4. Install one sync crank cover over each sync crank bore.
5. Secure each cover with two M5x10 screws.
6. Tighten to 75 in-lb.

Final Assembly (continued)

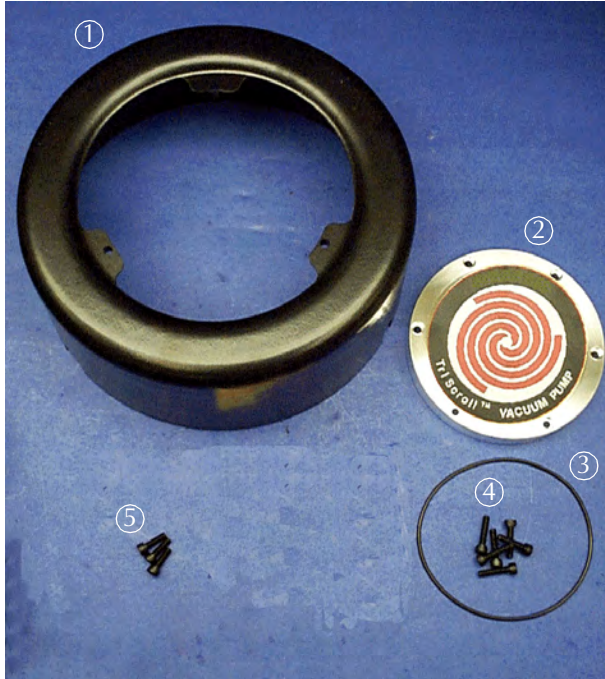

Replace the Cowling and Cover

Tools required:

- Allen wrench
- Krytox GPL 224 grease

Locate the following parts:

- ① Cowling
- ② Outboard cover
- ③ O-ring, 2-157, included in maintenance kit
- ④ M5x22 screws (6)
- ⑤ M5x10 shoulder screws (3)

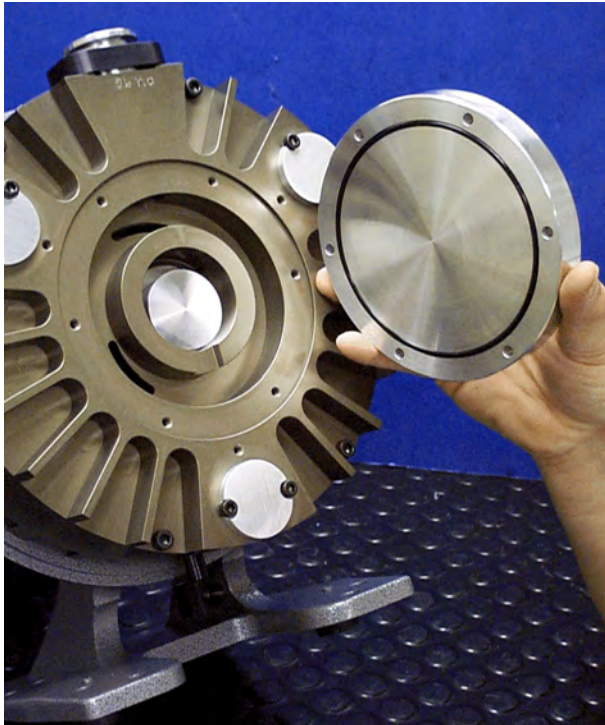

1. Lightly grease the O-ring and insert it into the groove on the outboard cover.

Final Assembly (continued)



2. Secure the outboard cover to the outboard housing with the six M5x22 screws.

Final Assembly (continued)



3. Install the cowling over the pump module.
4. Secure it with the three M5x10 shoulder screws.



This figure illustrates a fully reassembled TriScroll 300 pump.

Put the Pump Back into Service

The TriScroll 300 pump can be placed into service immediately after maintenance is complete. However, 24 hours of run time is required before base pressure of 10 mTorr can be achieved.

NOTE  *The 24 hour run time does not have to be continuous. If your application requires a low base pressure, it is wise to run the pump for the 24-hour period for optimum performance.*

Appendix: Pre- TBD Version of the TriScroll 300

This appendix details the differences between the TBD and later versions of the TriScroll 300.

TriScroll Disassembly

This figure shows the older check valve springs and plunger guides. This is relevant to TriScroll 300 disassembly. The older step is reproduced below the picture.



Older Check Valve Springs and Plunger Guides

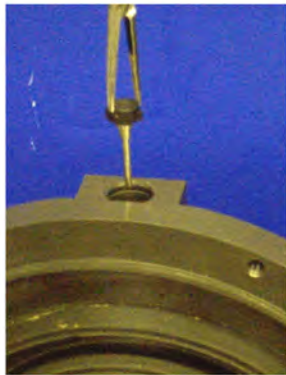

15. Using the hemostat pliers, remove the two check valves, two small springs, one large spring, two plunger guides and one spacer from the port in the inboard housing.

Inboard Housing Assembly

The inboard assembly is somewhat different and the figure below shows the exploded view for the older version.

Inboard Housing Exploded View

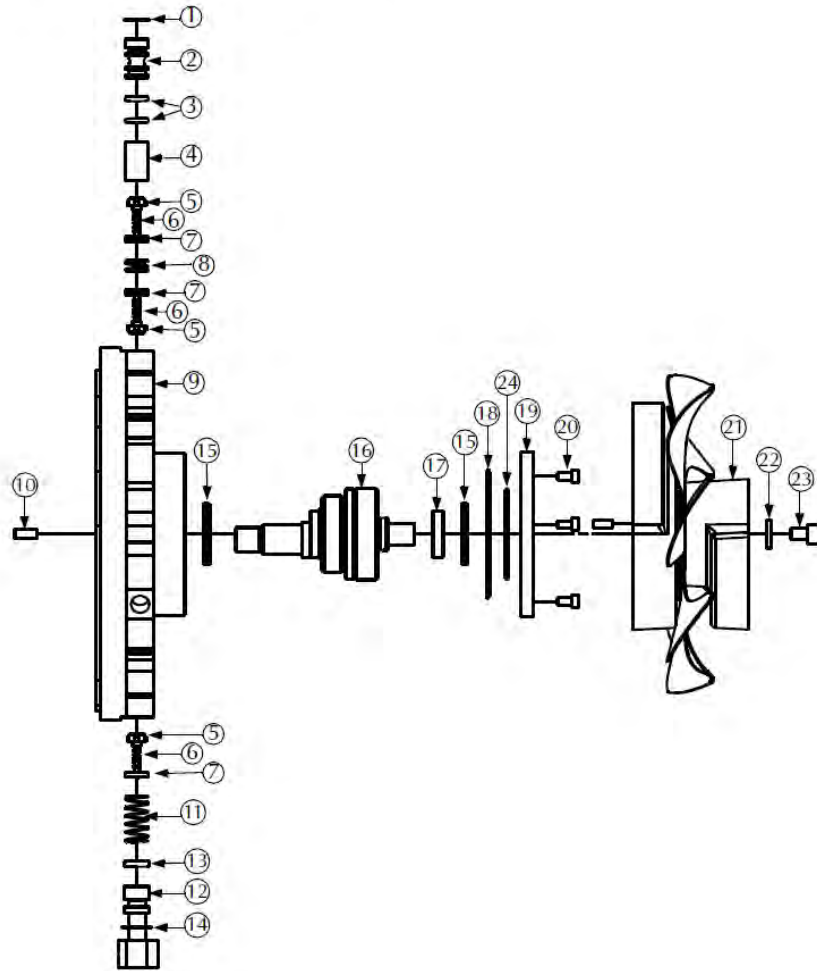

TriScroll 300 Dry Scroll Vacuum Pump

Callout	Part Number	Description	Quantity	
			PTS03101UNIV, PTS03103UNIV	PTS03001UNIV, PTS03003UNIV
①	NSS*	Snap Ring N500-62	1	1
②	S4735001	VDS4- Check Valve Plug	1	1
③	MK*	O-ring, Viton 2-111	2	2
④	S4737001	VDS4- Check Valve Spacer	1	1
⑤	S4723001	VDS4- Check Valve Assembly	2	3
⑥	660285573	Spring, S/S, .18 OD x .75 L x .014 Wire OD	2	3
⑦	S4720001	VDS4- Plunger Guide	2	3
⑧	660285565	Spring, S/S, .60 OD x .50 L x .045 Wire OD	1	1
⑨	NSS*	VDS4- Inboard Housing	1	1
⑩	NSS*	Dowel Pin, Steel, M6x16	2	2
⑪	660285568	Spring, S/S, .60 x 1.50 L x .045 Wire OD	-	1
⑫	S4706001	VDS4- Exhaust Fitting	1	1

MK = Included in major maintenance kit

TSK = Included in tip seal kit

NSS = Not sold separately

TriScroll 300 Dry Scroll Vacuum Pump

Callout	Part Number	Description	Quantity	
			PTS03101UNIV, PTS03103UNIV	PTS03001UNIV, PTS03003UNIV
⑬	MK*	O-ring, Viton 2-205	1	1
⑭	NSS*	Snap Ring, N5000-75	1	1
⑮	MK*	Shaft Seal, 32mm x 42mm x 4mm	2	2
⑯	NSS*	VDS4- Crankshaft Assembly	1	1
⑰	S4727001	VDS4- Seal Spacer	1	1
⑱	MK*	O-ring, Viton 2-152	1	1
⑲	S4712001	VDS4- Seal Housing	1	1
⑳	NSS*	Screw, Socket Head Cap, M5x10, Black Steel	3	3
㉑	NSS*	VDS4- Fan Assembly	1	1
㉒	NSS*	Washer, 11/32 x 3/4 x 1/8	1	1
㉓	NSS*	Screw, Socket Head Cap, M8x12, Black Steel	1	1
㉔	MK*	O-ring, Viton 2-140	1	1

Chemtech Scientific provides access to this content as a courtesy.
We do not own the content contained in this document.
All rights and credit go directly to its rightful owners.
www.chemtechsci.com
Call us at: 484-424-9415



Vacuum Products Division Instructions for returning products

Dear Customer:

Please follow these instructions whenever one of our products needs to be returned.

- 1) Complete the attached Request for Return form and send it to Agilent Technologies (see below), taking particular care to identify all products that have pumped or been exposed to any toxic or hazardous materials.
- 2) After evaluating the information, Agilent Technologies will provide you with a Return Authorization (RA) number via email or fax, as requested.
Note: Depending on the type of return, a Purchase Order may be required at the time the Request for Return is submitted. We will quote any necessary services (evaluation, repair, special cleaning, eg).
- 3) **Important steps for the shipment of returning product:**
 - Remove all accessories from the core product (e.g. inlet screens, vent valves).
 - Prior to shipment, drain any oils or other liquids, purge or flush all gasses, and wipe off any excess residue.
 - If ordering an Advance Exchange product, **please use the packaging from the Advance Exchange to return the defective product.**
 - Seal the product in a plastic bag, and package product carefully to avoid damage in transit. You are responsible for loss or damage in transit.
 - Agilent Technologies is not responsible for returning customer provided packaging or containers.
 - **Clearly label package with RA number.** Using the shipping label provided will ensure the proper address and RA number are on the package. Packages shipped to Agilent without a RA clearly written on the outside cannot be accepted and will be returned.
- 4) Return only products for which the RA was issued.
- 5) **Product being returned under a RA must be received within 15 business days.**
- 6) **Ship to the location specified on the printable label, which will be sent, along with the RA number, as soon as we have received all of the required information.** Customer is responsible for freight charges on returning product.
- 7) Return shipments must comply with all applicable **Shipping Regulations** (IATA, DOT, etc.) and carrier requirements.

**Vacuum Products Division
Request for Return Form
(Health and Safety Certification)**

Please read important policy information on Page 3 that applies to all returns.

1) CUSTOMER INFORMATION

Company Name:		Contact Name:	
Tel:	Email:	Fax:	
Customer Ship To:		Customer Bill To:	
Europe only: VAT reg. Number:		USA/Canada only: <input type="checkbox"/> Taxable <input type="checkbox"/> Non-taxable	

2) PRODUCT IDENTIFICATION

Product Description	Agilent P/N	Agilent S/N	Original Purchasing Reference

3) TYPE OF RETURN (Choose one from each row and supply Purchase Order if requesting a billable service)

- 3A.** Non-Billable Billable **New PO #** (hard copy must be submitted with this form):
- 3B.** Exchange Repair Upgrade Consignment/Demo Calibration Evaluation Return for Credit

4) HEALTH and SAFETY CERTIFICATION

AGILENT TECHNOLOGIES CANNOT ACCEPT ANY PRODUCTS CONTAMINATED WITH BIOLOGICAL OR EXPLOSIVE HAZARDS, RADIOACTIVE MATERIAL, OR MERCURY AT ITS FACILITY.
Call Agilent Technologies to discuss alternatives if this requirement presents a problem.

The equipment listed above (check one):

HAS NOT pumped or been exposed to any toxic or hazardous materials. OR

HAS pumped or been exposed to the following toxic or hazardous materials. If this box is checked, the following information must also be filled out. Check boxes for all materials to which product(s) pumped or was exposed:

Toxic Corrosive Reactive Flammable Explosive Biological Radioactive

List all toxic/hazardous materials. Include product name, chemical name, and chemical symbol or formula:

NOTE: If a product is received at Agilent which is contaminated with a toxic or hazardous material that was not disclosed, **the customer will be held responsible** for all costs incurred to ensure the safe handling of the product, and **is liable** for any harm or injury to Agilent employees as well as to any third party occurring as a result of exposure to toxic or hazardous materials present in the product.

Print Name: _____ **Authorized Signature:** **Date:** _____

5) FAILURE INFORMATION:

Failure Mode (REQUIRED FIELD. See next page for suggestions of failure terms):
Detailed Description of Malfunction: (Please provide the error message)
Application (system and model):

I understand and agree to the terms of Section 6, Page 3/3.		
Print Name:	Authorized Signature:	Date:



Vacuum Products Division Request for Return Form (Health and Safety Certification)

Please use these Failure Mode to describe the concern about the product on Page 2.

TURBO PUMPS and TURBO CONTROLLERS

APPARENT DEFECT/MALFUNCTION	POSITION	PARAMETERS
- Does not start - Does not spin freely - Does not reach full speed - Mechanical Contact - Cooling defective	- Noise - Vibrations - Leak - Overtemperature - Clogging	- Vertical - Horizontal - Upside-down - Other:
		Power: Rotational Speed: Current: Inlet Pressure: Temp 1: Foreline Pressure: Temp 2: Purge flow: OPERATING TIME:

ION PUMPS/CONTROLLERS

- Bad feedthrough	- Poor vacuum
- Vacuum leak	- High voltage problem
- Error code on display	- Other

VALVES/COMPONENTS

- Main seal leak	- Bellows leak
- Solenoid failure	- Damaged flange
- Damaged sealing area	- Other

LEAK DETECTORS

- Cannot calibrate	- No zero/high background
- Vacuum system unstable	- Cannot reach test mode
- Failed to start	- Other

INSTRUMENTS

- Gauge tube not working	- Display problem
- Communication failure	- Degas not working
- Error code on display	- Other

SCROLL AND ROTARY VANE PUMPS

- Pump doesn't start	- Noisy pump (describe)
- Doesn't reach vacuum	- Over temperature
- Pump seized	- Other

DIFFUSION PUMPS

- Heater failure	- Electrical problem
- Doesn't reach vacuum	- Cooling coil damage
- Vacuum leak	- Other

Section 6) ADDITIONAL TERMS

Please read the terms and conditions below as they apply to all returns and are in addition to the Agilent Technologies Vacuum Product Division – Products and Services Terms of Sale.

- Customer is responsible for the freight charges for the returning product. Return shipments must comply with all applicable **Shipping Regulations** (IATA, DOT, etc.) and carrier requirements.
- Customers receiving an Advance Exchange product agree to return the defective, rebuildable part to Agilent Technologies **within 15 business days**. Failure to do so, or returning a non-rebuildable part (crashed), will result in an invoice for the non-returned/non-rebuildable part.
- Returns for credit toward the purchase of new or refurbished Products are subject to prior Agilent approval and may incur a restocking fee. Please reference the original purchase order number.
- Units returned for evaluation will be evaluated, and a quote for repair will be issued. If you choose to have the unit repaired, the cost of the evaluation will be deducted from the final repair pricing. A Purchase Order for the final repair price should be issued within 3 weeks of quotation date. Units without a Purchase Order for repair will be returned to the customer, and the evaluation fee will be invoiced.
- A Special Cleaning fee will apply to all exposed products per Section 4 of this document.
- If requesting a calibration service, units must be functionally capable of being calibrated.