

Chemtech Scientific provides access to this content as a courtesy.  
We do not own the content contained in this document.  
All rights and credit go directly to its rightful owners.  
[www.chemtechsci.com](http://www.chemtechsci.com)  
Call us at: 484-424-9415



*Vacuum Products Division*

***TriScroll™ 600  
Series  
Dry Scroll  
Vacuum Pump***

*MAJOR MAINTENANCE  
MANUAL*

Manual No. 699904300  
Revision G  
May 2004

# TriScroll™ 600 Series Dry Scroll Vacuum Pump



*TriScroll is a trademark of Agilent.*

*Loctite and PST are registered trademarks of Loctite Corporation.*

*Krytox, Teflon and Viton are registered trademarks of E. I. du Pont de Nemours and Company.*

# Table of Contents

<b>Declaration of Conformity</b>	
<b>Preface</b> . . . . .	<b>vi</b>
Safety Considerations . . . . .	vi
Related TriScroll Manuals . . . . .	viii
Maintenance and Tool Kits . . . . .	viii
Factory Service Options . . . . .	ix
Contacting Agilent . . . . .	ix
<b>Major Maintenance</b> . . . . .	<b>1</b>
General Information . . . . .	1
Required Equipment . . . . .	1
Maintenance Tool Kit . . . . .	2
Major Maintenance Tool Kit . . . . .	4
Tip Seal Tool Kit . . . . .	6
<b>TriScroll 600 Disassembly</b> . . . . .	<b>7</b>
Remove and Disassemble the Intake Fitting . . . . .	7
Remove and Disassemble the Outboard Housing . . . . .	8
Remove the Sync Cranks . . . . .	10
Remove and Disassemble the Orbiting Plate . . . . .	12
Remove and Disassemble the Inboard Housing . . . . .	19
<b>Crankshaft Assembly</b> . . . . .	<b>29</b>
Crankshaft Exploded View . . . . .	29
Assemble the Crankshaft . . . . .	30
<b>Inboard Housing Assembly</b> . . . . .	<b>33</b>
Inboard Housing Exploded View . . . . .	33
Inboard Housing Assembly . . . . .	35
Insert the Shaft Seal . . . . .	35
Insert the Crankshaft . . . . .	37
Insert the Seal Housing . . . . .	39
Install the Vents and Plugs . . . . .	42
Exhaust Port Reassembly . . . . .	44
Bypass Port Reassembly . . . . .	47
<b>Orbiting Plate Assembly</b> . . . . .	<b>51</b>
Orbiting Plate Exploded View . . . . .	51
Orbiting Plate Assembly . . . . .	53
Install the Bearing Assembly . . . . .	53
Install the Wave Washer and Shaft Seal . . . . .	58
Install the Needle Bearings . . . . .	61
<b>TriScroll 600 Assembly</b> . . . . .	<b>65</b>
TriScroll 600 Exploded View . . . . .	65
Final Assembly . . . . .	69
Install the Orbiting Plate . . . . .	72
Install the Sync Crank and Tip Seals into the Outboard Housing . . . . .	79
Install the Outboard Housing . . . . .	82
Replace the Cowling, Cover, and Intake Fitting . . . . .	83
Put the Pump Back into Service . . . . .	86
<b>Request for Return Health</b>	
<b>Sales and Service Offices</b>	

## TriScroll 600 Dry Scroll Vacuum Pump

---

*This page intentionally left blank.*

**Declaration of Conformity**  
**Konformitätserklärung**  
**Déclaration de Conformité**  
**Declaración de Conformidad**  
**Verklaring de Overeenstemming**  
**Dichiarazione di Conformità**

declare under our sole responsibility that the product,  
erklären, in alleiniger Verantwortung, daß dieses Produkt,  
déclarons sous notre seule responsabilité que le produit,  
declaramos, bajo nuestra sola responsabilidad, que el producto,  
verklaren onder onze verantwoordelijkheid, dat het product,  
dichiariamo sotto nostra unica responsabilità, che il prodotto,

**TriScroll Series Vacuum Pump**

to which this declaration relates is in conformity with the following standard(s) or other normative documents.  
auf das sich diese Erklärung bezieht, mit der/den flogenden Norm(en) oder Richtlinie(n) übereinstimmt.  
auquel se réfère cette déclaration est conforme à la (aux) norme(s) ou au(x) document(s) normatif(s).  
al que se refiere esta declaración es conforme a la(s) norma(s) u otro(s) documento(s) normativo(s).  
waamaar deze verklaring verwijst, aan de volende norm(en) of richtlijn(en) beantwoordt.  
a cui se riferisce questa dichiarazione è conforme alla/e seguente/i norma/o documento/i normativo/i.

**98/37/EEC, Machinery Directive**

EN 1012-2:1996

Safety of machinery - principles for risk assessment

EN 60204-1

Electrical equipment of industrial machines; general requirements

**73/023/EEC, Low Voltage Directive**

EN 60034 part 1

Rotating electrical machines - Part 1: Rating and performance

**89/336/EEC, Electromagnetic Compatibility Directive**

EN 61000-4-2

Testing and Measurement Techniques - Electrostatic Discharge Immunity Test

## Preface

This manual provides the information you need to successfully perform scheduled maintenance on your Agilent TriScroll™ Dry Vacuum Pump. The time to perform major rebuild is typically 18,000 hours. If you have questions that are not addressed in this manual, please contact the nearest Agilent service facility listed on the rear cover of this manual.

## Safety Considerations

READ THE FOLLOWING INSTRUCTIONS. TAKE ALL NECESSARY PRECAUTIONS.

The following format is used in this manual to call attention to hazards:

### WARNING



*The warning messages are for attracting the attention of the operator to a particular procedure or practice which, if not followed correctly, could lead to serious injury.*

### CAUTION



*The caution messages are displayed before procedures, which if not followed, could cause damage to the equipment.*

### NOTE



*The notes contain important information taken from the text.*

Maintenance personnel must be aware of all hazards associated with this equipment. They must know how to recognize hazardous and potentially hazardous conditions, and know how to avoid them. The consequences of work performed by unskilled or improperly trained maintenance personnel, or careless operation of the equipment employed in the specified maintenance procedures can be serious.

Every maintenance person must read and thoroughly understand the materials discussed and the instructions provided in this manual, as well as any additional information provided by Agilent.

## TriScroll 600 Dry Scroll Vacuum Pump

---

All warnings and cautions must be read carefully, fully understood, and strictly observed. Consult local, state/province, and national agencies regarding specific requirements and regulations. Address any safety, operation, and/or maintenance questions to the nearest Agilent location.

### WARNING



*Disconnect power from the TriScroll 600 before performing any maintenance procedure.*

*Allow the pump to cool before performing any maintenance procedure. Approximate cool-down time is one to two hours.*

### CAUTION



*Wipe all O-rings clean with a lint-free cloth before installation to ensure that no foreign matter is present to impair the seal.*

*Do not use alcohol, methanol or other solvents on O-rings. To do so causes deterioration and reduces their ability to hold a vacuum.*

*If applicable, apply a small amount of Krytox<sup>®</sup> GPL 224 grease and wipe the O-rings “shiny” dry.*

### NOTE



*Agilent recommends replacing all O-rings during routine maintenance or during any maintenance procedure requiring that O-rings be removed.*

*Unless otherwise stated, apply Loctite<sup>®</sup> 242 or Loctite PST<sup>®</sup> to the first few threads only. Apply just enough to obtain a seal.*

### WARNING



*The TriScroll 600 weighs 32 kg (70 lbs). To avoid injury, use proper lifting techniques when moving the pump.*

## TriScroll 600 Dry Scroll Vacuum Pump

### Related TriScroll Manuals

Manuals related to the installation and operation, tip seal and pump module replacement for TriScroll 600 series pumps are listed in the following table:

Title	Applicable TriScroll Model	Part Number
Pump Module Replacement	All TriScroll 600 Series Models	699904305
Tip Seal Replacement Manual	All TriScroll 600 Series Models	699904310
Installation and Operation Manual	All TriScroll 600 Series Models	699904290

### Maintenance and Tool Kits

Material and tooling required to perform maintenance on TriScroll pumps is provided in kit form. A description of each kit and ordering information is provided in the following table:

Description	Contents	Applicable TriScroll Model	Part Number
Major Maintenance Kit	All bearings, bearing seals, bearing lubricant, O-rings, and tip seals required to rebuild TriScroll 600 Series pumps.	All TriScroll 600 Series models	PTSS0600MK
Maintenance Tool Kit	All fixtures and tools required to perform any maintenance on TriScroll 600 Series pumps.	All TriScroll 600 Series models	PTSS0600TK
Tip Seal Tool Kit	All tools required to change the tip seals on any TriScroll Series pump.	All TriScroll Series models	PTSTSTKIT
Replacement Tip Seal Set	Replacement tip seals and static O-rings for TriScroll 600 Series pumps.	All TriScroll 600 Series models	PTSS0600TS
	<i>NOTE: The Maintenance Tool Kit or the Tip Seal Tool Kit is required for tip seal replacement.</i>		



## TriScroll 600 Dry Scroll Vacuum Pump

---

### Factory Service Options

Agilent offers factory-rebuild service or advance exchange of complete TriScroll Pumps or TriScroll Pump Modules. Contact your nearest Agilent sales office for price and availability information. Select your preferred service option from the table below.

Factory Service Options	Part Number
Advance Exchange TriScroll 600 Single Phase	EXPPTS06001
Advance Exchange TriScroll 600 Three Phase	EXPPTS06003
Advance Exchange TriScroll 610 Single Phase	EXPPTS06101
Advance Exchange TriScroll 610 Three Phase	EXPPTS06103
Advance Exchange TriScroll 600 Pump Module Only	EXPTS0600SC
Advance Exchange TriScroll 610 Pump Module Only	EXPTS0610SC
Service/Rebuild TriScroll 600 Pump (Single or Three Phase)	PTS0600KMA
Service/Rebuild TriScroll 610 Pump (Single or Three Phase)	PTS0610KMA
Service/Rebuild TriScroll 600 Pump Module Only	PTS0600SCRP
Service/Rebuild TriScroll 610 Pump Module Only	PTS0610SCRP

### Contacting Agilent

In the United States, you can contact Agilent Customer Service at 1-800-882-7426. See the back cover of this manual for a listing of our sales and service offices.

## TriScroll 600 Dry Scroll Vacuum Pump

---

*This page intentionally left blank.*

# Major Maintenance

## General Information

Agilent TriScroll 600 series pumps are designed to provide years of trouble-free service if maintenance procedures and intervals are observed. Bearing grease replenishment and tip seal replacement are recommended when the pump base pressure has risen to an unacceptably high level for your application. Bearings, rotary seals and O-rings should also be replaced if the pump exhibits humming or grinding noises from the bearings. Main bearing life may be shortened if your application requires the pumping of high quantities of water vapor. Use of the bearing purge will keep this water from impacting bearing life.

## Required Equipment

- ❑ **Maintenance Tool Kit:** PTSS0600TK (page 2)
- ❑ **Major Maintenance Kit:** PTSS0600MK (page 4)
- ❑ **Arbor Press:** 1/2 ton or larger, 10" work diameter capacity, 8" capacity over table
- ❑ **Oven:** 400 °F temperature capability, 11" wide x 11" deep x 4" high minimum chamber, 500 watt or higher heating capacity
- ❑ **Heat Resistant Surface**
- ❑ **Vacuum Gauge:** Capable of measuring pressure of 5 mTorr to 20 mTorr with an accuracy of  $\pm 1$  mTorr. A capacitance manometer or Pirani gauge is recommended.

## Maintenance Tool Kit

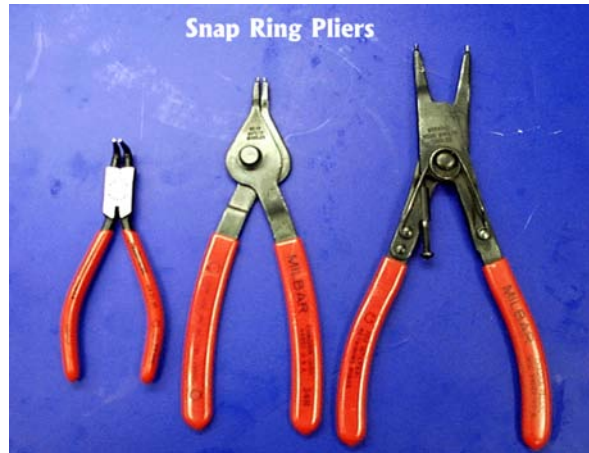
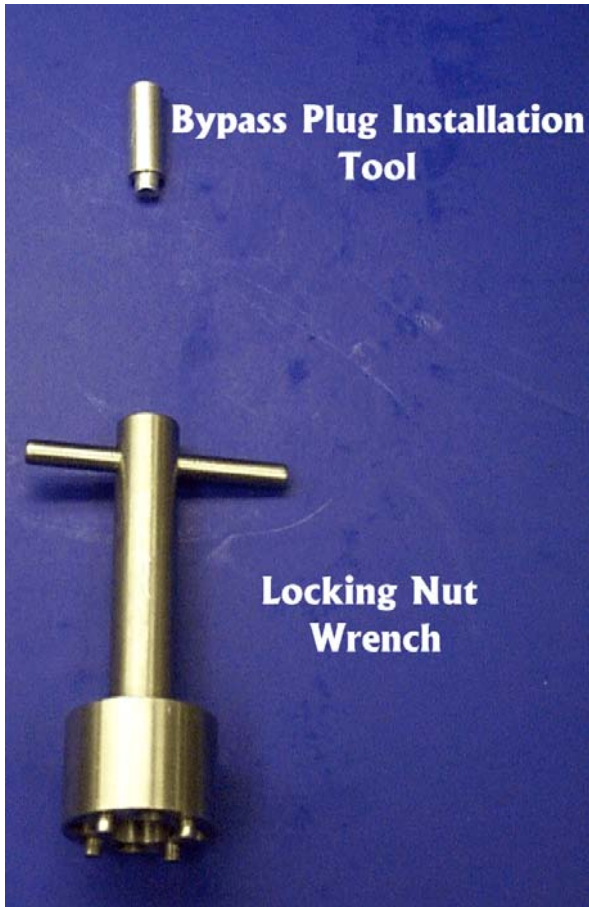

Maintenance Tool Kit (continued)



## Major Maintenance Tool Kit

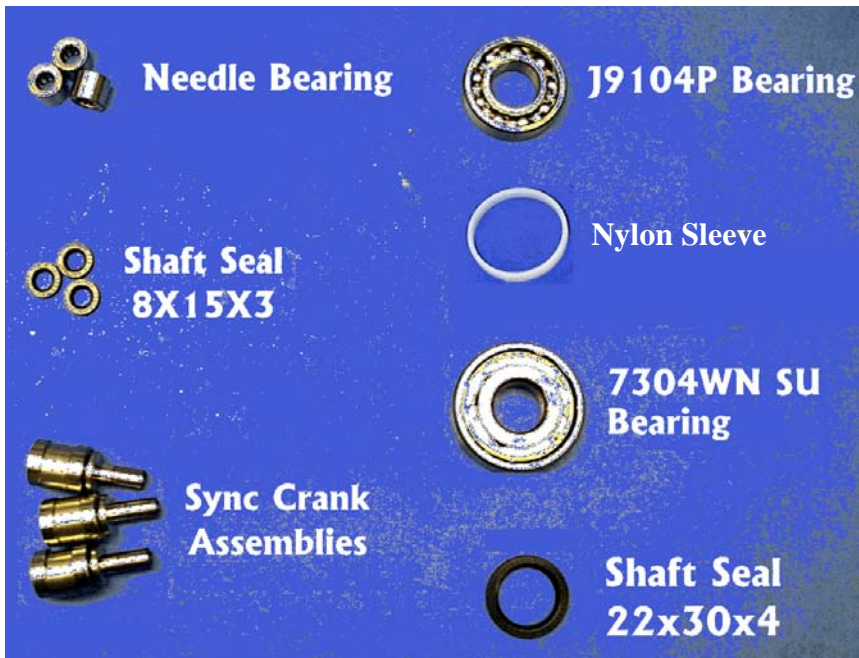

Major Maintenance Tool Kit (continued)

TS-600 O-rings

O-ring Part Number	Quantity	Inside Diameter (in.)	Cross-Section (in.)
2-016	6	0.614	0.070
2-113	2	0.549	0.103
2-115	1	0.674	0.103
2-127	1	1.424	0.103
2-137	1	2.050	0.103
2-152	1	3.237	0.103
2-157	1	4.487	0.103
2-207	1	0.546	0.139
2-273	1	9.734	0.139

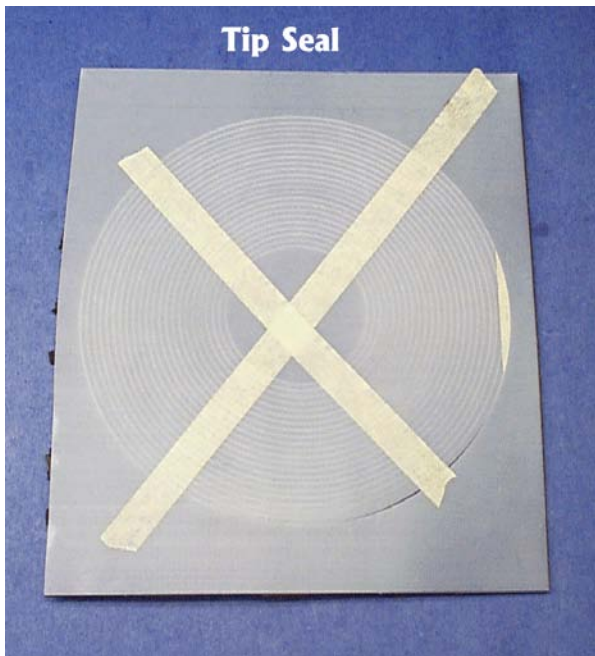

## Tip Seal Tool Kit

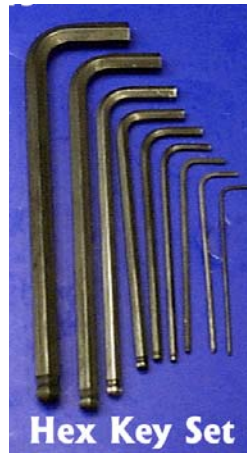



## TriScroll 600 Disassembly



### Remove and Disassemble the Intake Fitting

1. Remove the two M5x16 screws from the intake assembly.
2. Remove the intake assembly from the top of the pump.
3. Remove and discard the O-ring from the groove on the underside of the intake fitting.



4. Remove the intake clamp from the intake fitting.
5. Remove and discard the snap ring from the intake fitting.
6. Remove the screen from the intake fitting.

## TriScroll 600 Disassembly (continued)

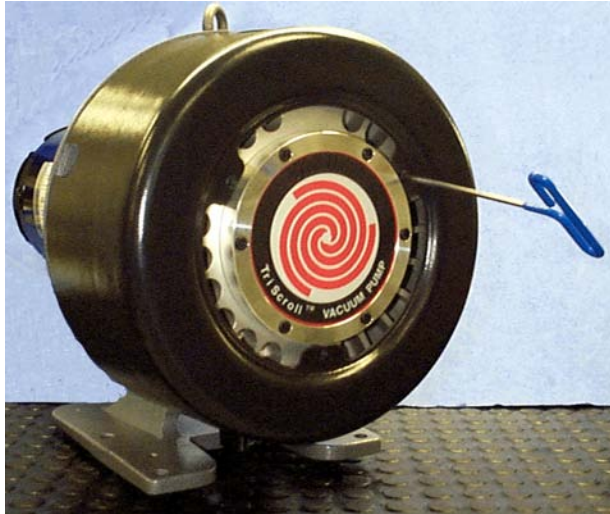

### Remove and Disassemble the Outboard Housing

1. Remove the three M5x16 screws that attach the cowling to the module.
2. Remove the cowling.



3. Remove the six M5x22 screws that attach the outboard cover to the outboard housing.

## TriScroll 600 Disassembly (continued)



4. Remove the outboard cover.
5. Remove and discard the O-ring.

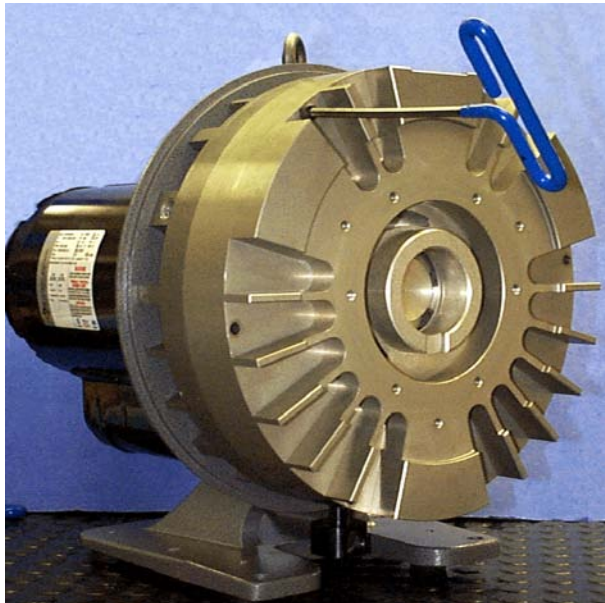

6. Remove the six M6x55 screws that attach the outboard housing to the outboard housing.
7. Remove the outboard housing.
8. Remove and discard the O-ring from the inboard housing.

## TriScroll 600 Disassembly (continued)

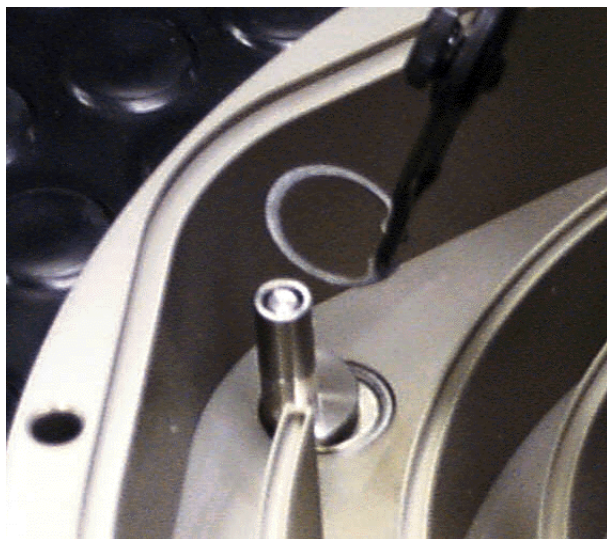



### Remove the Sync Cranks

1. Remove the snap ring from each sync crank bore.



2. Remove and discard the sync cranks.

**NOTE**  *If the sync cranks don't slide out easily, heat the outboard housing to approximately 150 °F.*

**WARNING**  *Use heat resistant gloves when handling the outboard housing after it is heated.*

## TriScroll 600 Disassembly (continued)

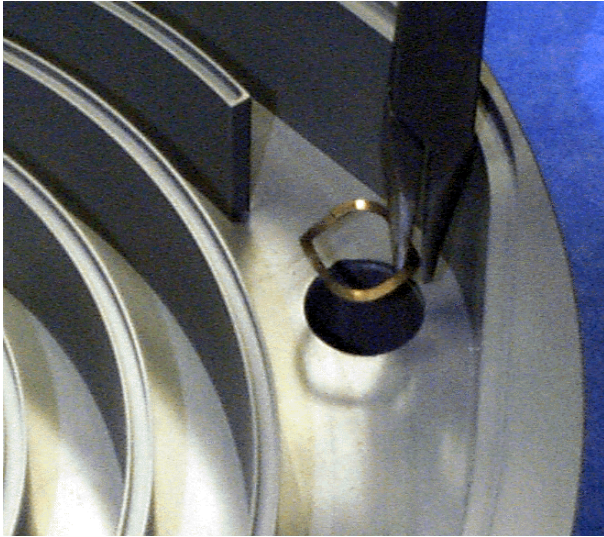

3. Using the hemostat pliers, remove the wave washer.

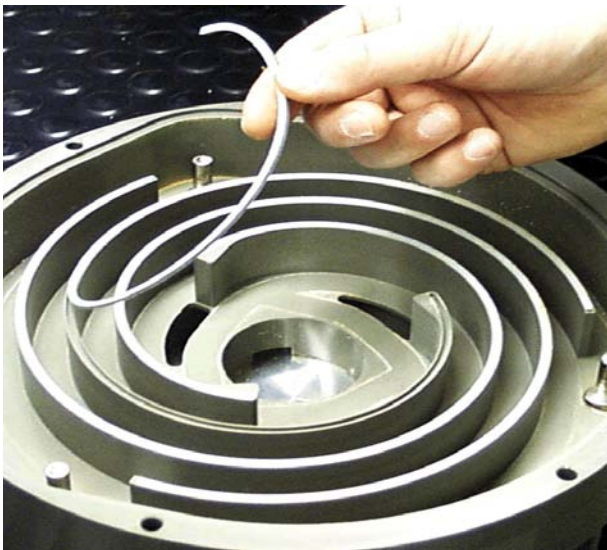

4. Remove and discard the tip seals from the outboard housing.

## TriScroll 600 Disassembly (continued)



### Remove and Disassemble the Orbiting Plate

1. Remove the snap ring that is holding the orbiting cup in the orbiting plate.



2. Remove the orbiting cup.
3. Remove and discard the O-ring.

## TriScroll 600 Disassembly (continued)



4. Use the locking nut wrench to hold the locking nut.
5. Loosen the four M4x12 screws in the locking nut.
6. Remove the locking nut.

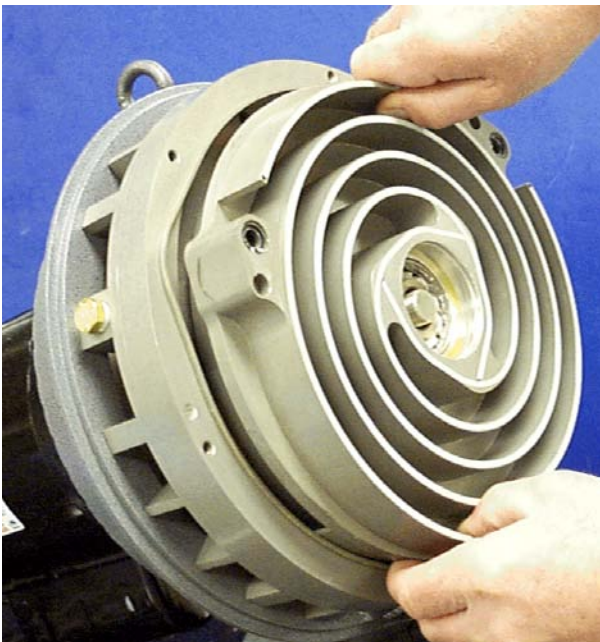

7. Remove the orbiting plate from the crankshaft.

## TriScroll 600 Disassembly (continued)



8. Remove and discard the tip seals from both sides of the orbiting plate.

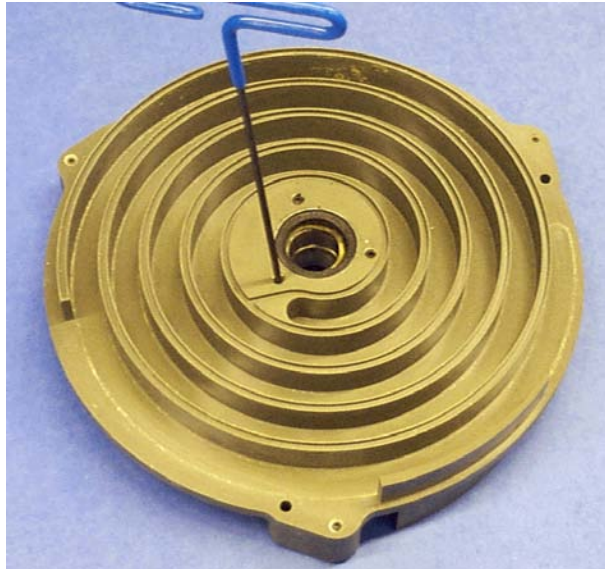

9. Remove the six M5x5 set screws from the orbiting plate.

**NOTE**



*The set screws are held in with Loctite.*



## TriScroll 600 Disassembly (continued)

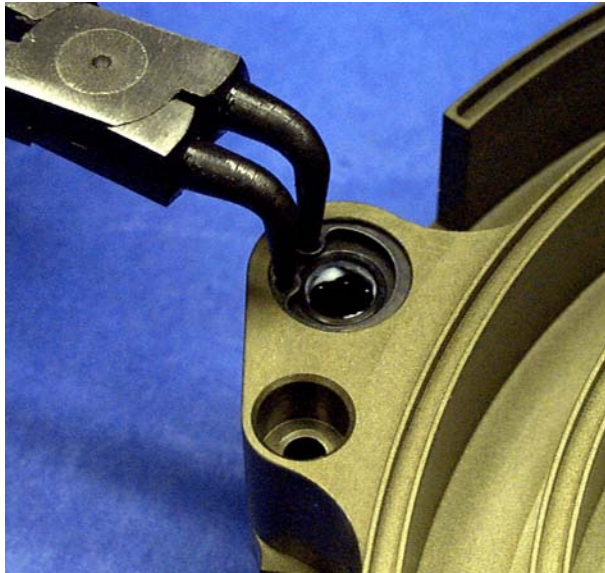

10. Remove the three snap rings that hold the needle bearings and shaft seals in the orbiting plate.

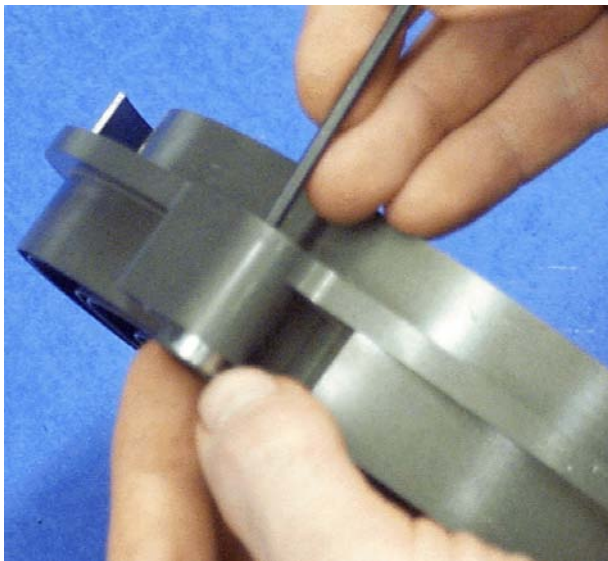

11. Push out and discard the three needle bearings and shaft seals.

## TriScroll 600 Disassembly (continued)

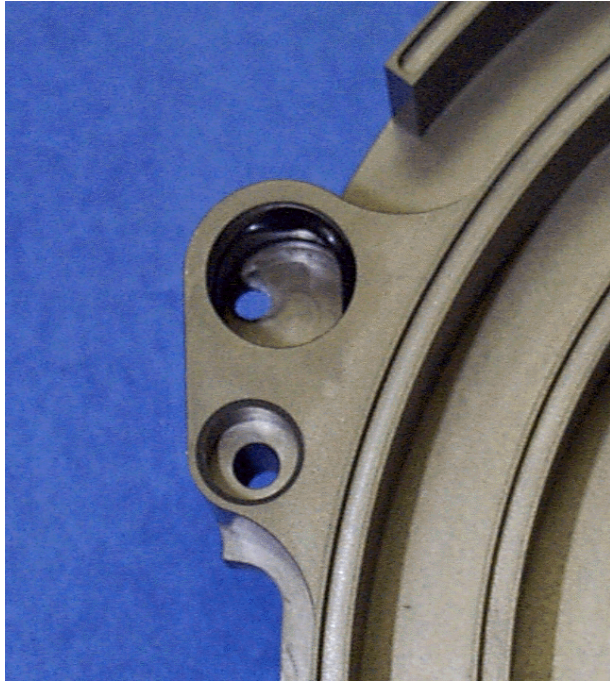

12. Remove and discard the six O-rings from the three sync bearing bores in the orbiting plate.

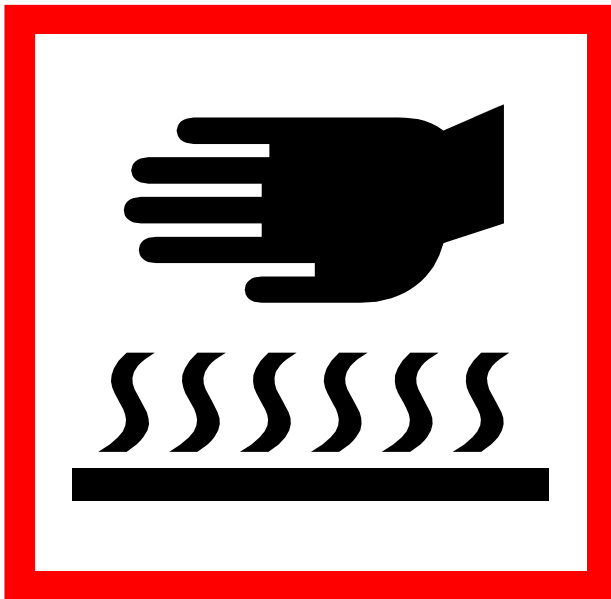

**WARNING** *This step requires the use of heat resistant gloves. Do not proceed without them!*



13. Heat the orbiting plate for a minimum of 1 hour in a 350 °F oven.

## TriScroll 600 Disassembly (continued)

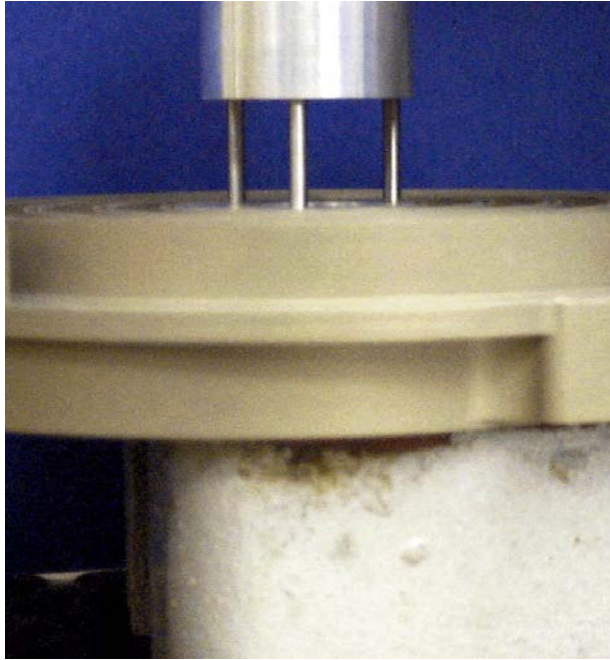

14. Immediately after removing the orbiting plate from oven, use the bearing extractor tool and arbor press to press out the two bearings, orbiting spacer, nylon sleeve and wave washer from the orbiting plate.



The parts removed from the orbiting plate in step 14 are:

- ① 7304WN SU bearing
- ② J9104P bearing
- ③ Wave washer
- ④ Orbiting spacer
- ⑤ Nylon sleeve

15. Allow the orbiting plate to air cool until it can be handled with bare hands.  
This generally takes an hour.

## TriScroll 600 Disassembly (continued)



16. Remove and discard the shaft seal from the orbiting plate.

**NOTE**



*The shaft seal is held in place with Loctite®.*



17. Remove and discard the tip seal from the inboard housing.

## TriScroll 600 Disassembly (continued)

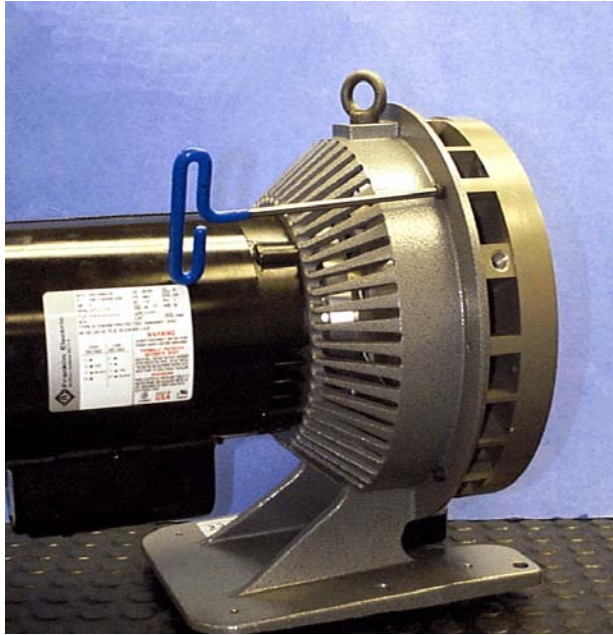

### Remove and Disassemble the Inboard Housing

1. Remove the four M6x16 screws that attach the inboard housing to the frame.

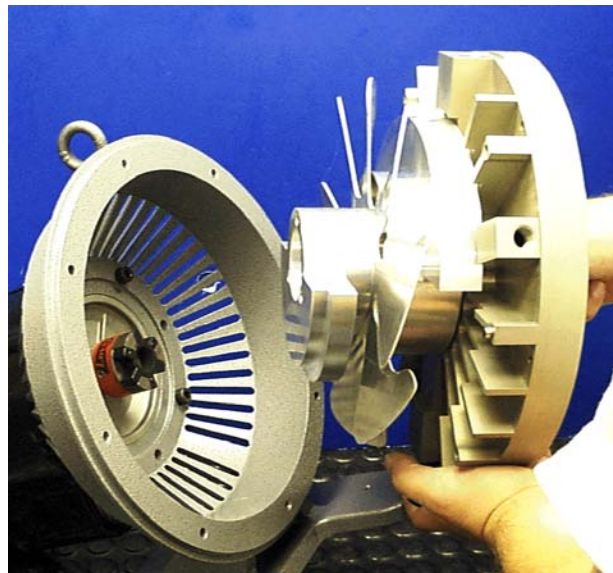

2. Remove the inboard housing from the frame.

## TriScroll 600 Disassembly (continued)

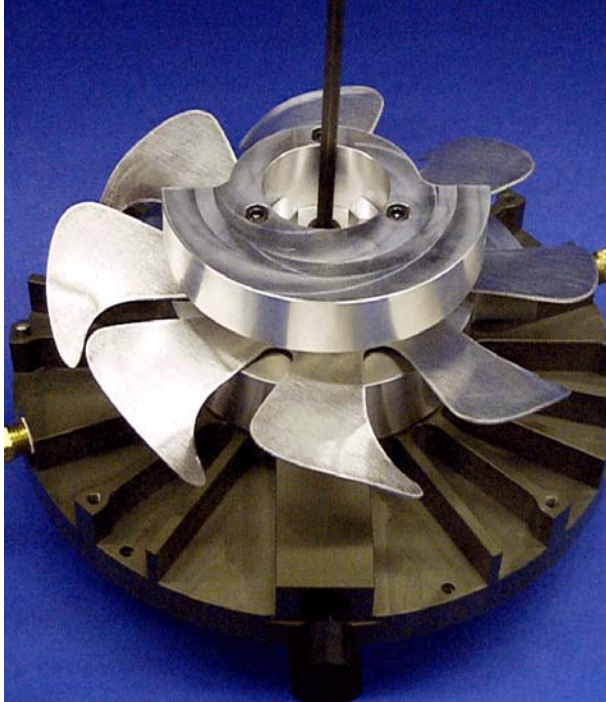

3. Remove the M8x12 screw and washer that attach the fan assembly to the crankshaft, then remove the fan assembly.

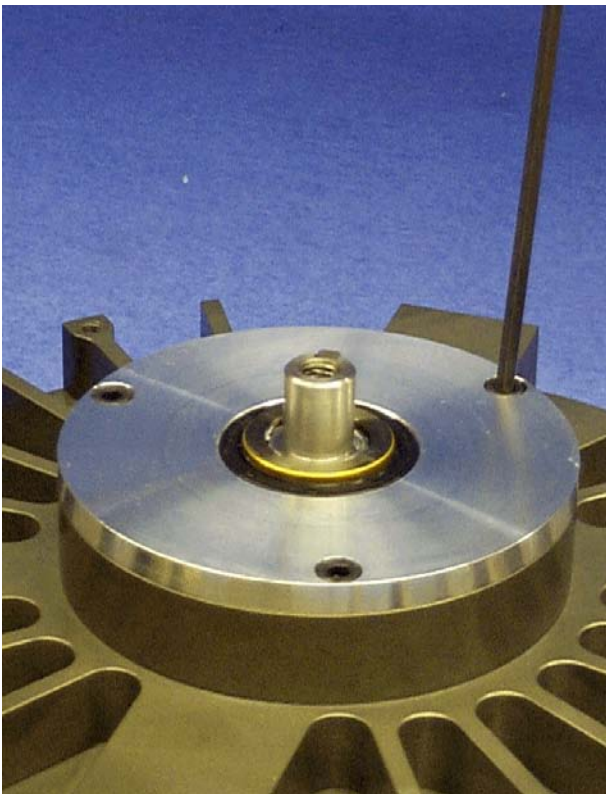

4. Remove the three M5x10 screws that hold the seal housing to the inboard housing.

## TriScroll 600 Disassembly (continued)



5. Remove the seal housing.
6. Remove and discard the O-rings and the shaft seal from seal housing.



7. Remove the shaft seal spacer from the crankshaft.

## TriScroll 600 Disassembly (continued)



8. Push the crankshaft out of the inboard housing.
9. Remove the key from slot in the crankshaft.
10. Remove and discard the O-ring from the crankshaft.

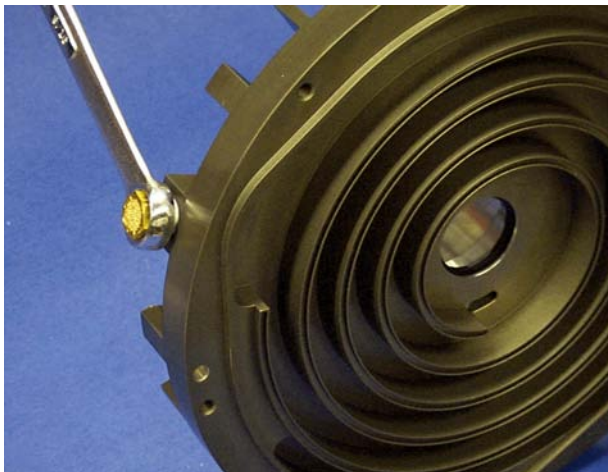

11. Remove the two pipe plugs from the inboard housing.

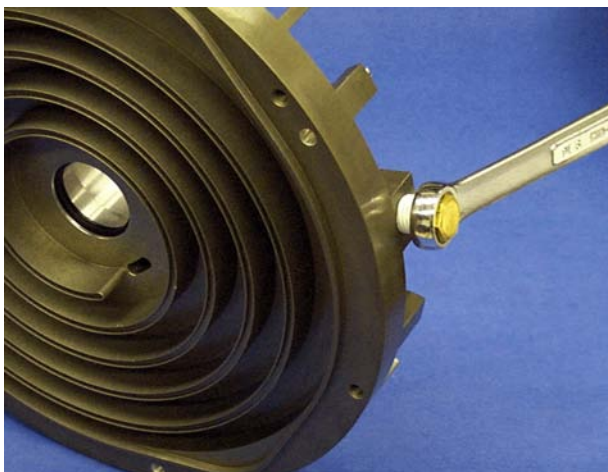



## TriScroll 600 Disassembly (continued)

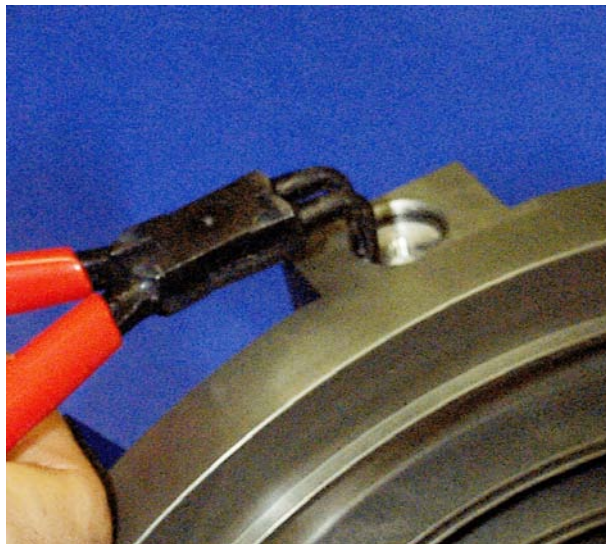

12. Remove the snap ring that is holding the check valve plug in the inboard housing.

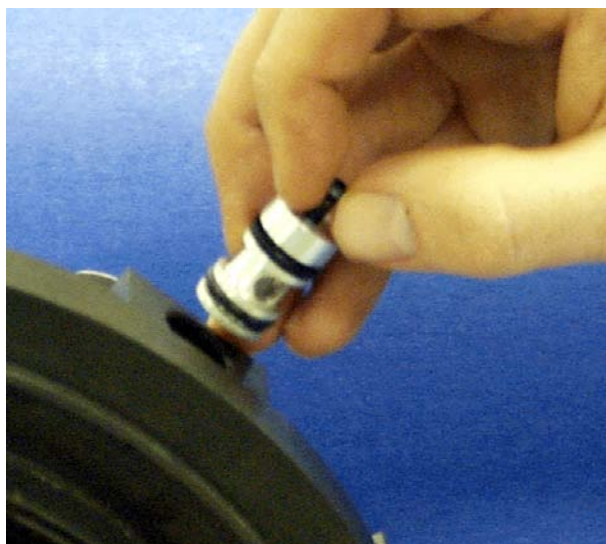

13. Remove the check valve plug by installing an M4 screw and then pulling out the plug.
14. Remove and discard the two O-rings.

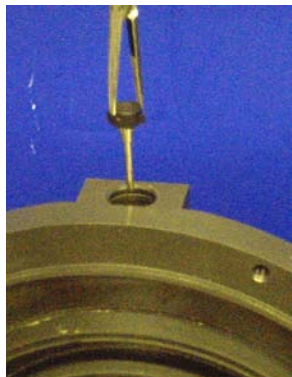

15. Using the hemostat pliers, remove the two check valves, two small springs, one large spring, two plunger guides and one spacer from the port in the inboard housing.

## TriScroll 600 Disassembly (continued)

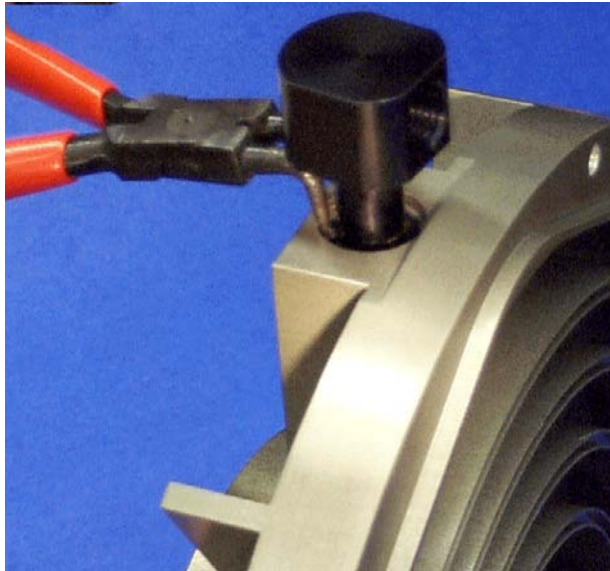

16. Remove the snap ring that is holding the exhaust fitting in the inboard housing.

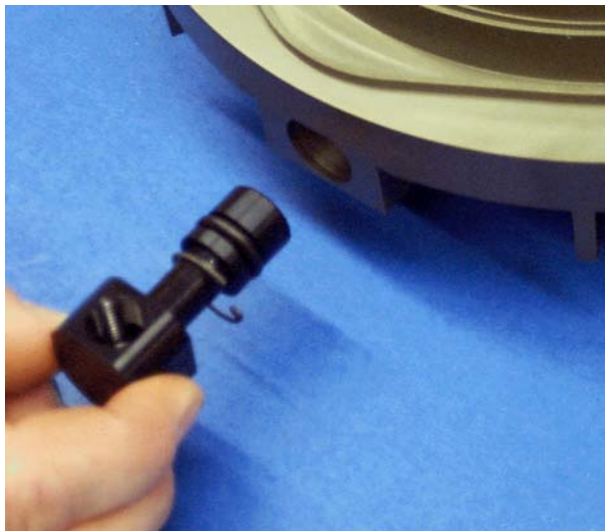

17. Remove the exhaust fitting.

18. Remove and discard the O-ring.

## TriScroll 600 Disassembly (continued)

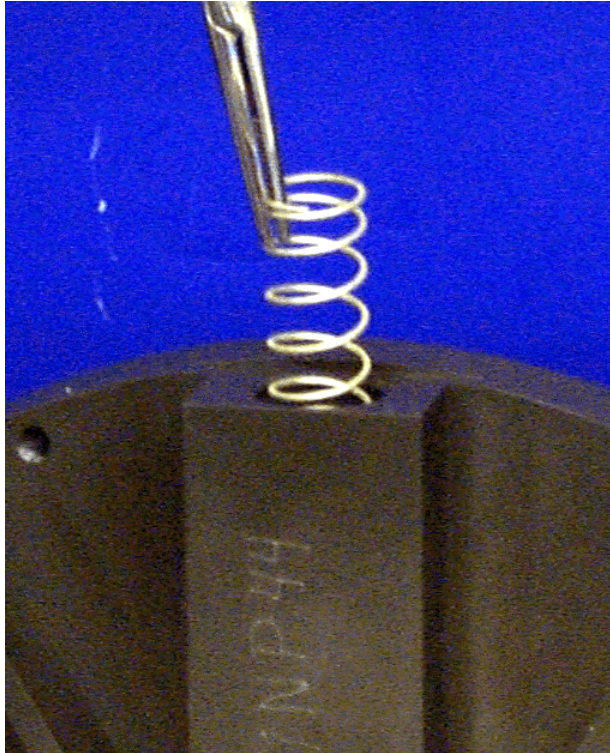

**NOTE**

*The next step applies to all models except the 610.*



19. Using the hemostat pliers, remove the large spring, plunger guide, small spring and check valve from the exhaust port in the inboard housing.

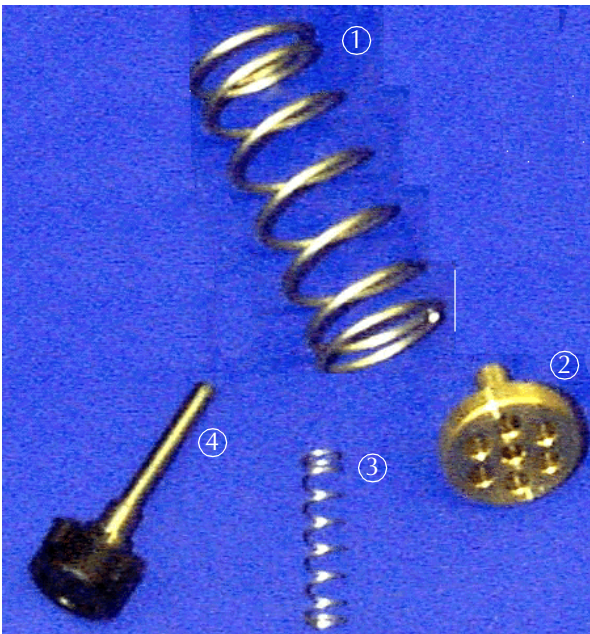

The parts removed from the exhaust are:

- ① Large spring
- ② Plunger guide
- ③ Small spring
- ④ Check valve

## TriScroll 600 Disassembly (continued)

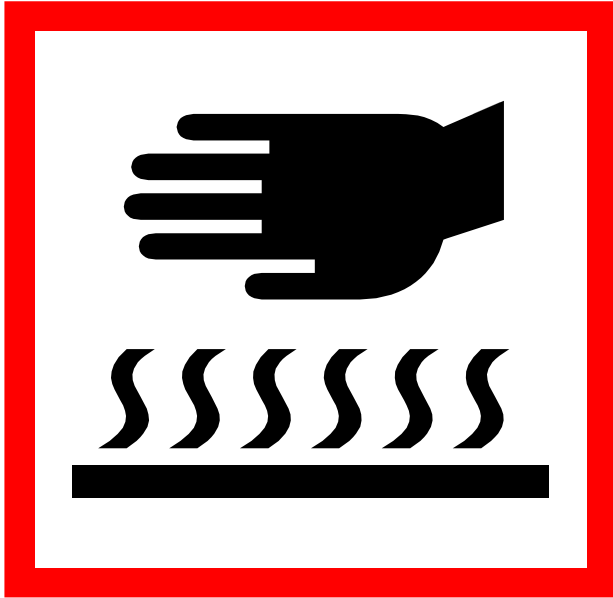

**WARNING** *This step requires the use of heat resistant gloves. Do not proceed without them!*



20. Heat the inboard housing for a minimum of 1 hour in a 350 °F oven.

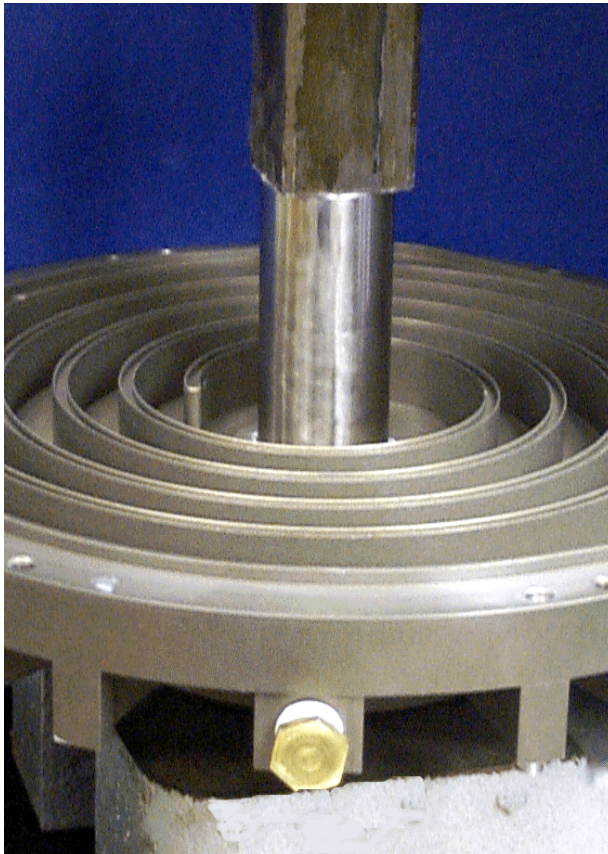

21. Immediately after removing the inboard housing from the oven, remove the two bearings, bearing spacer and wave washer from inboard housing.
22. Use the main bearing extractor tool to push the bearings out if the bearings do not fall out.

## TriScroll 600 Disassembly (continued)



The parts removed from the inboard housing are:

- ① Bearing spacer
- ② 7205W SU bearings (2)
- ③ 7305WN SU bearing
- ④ Wave washer

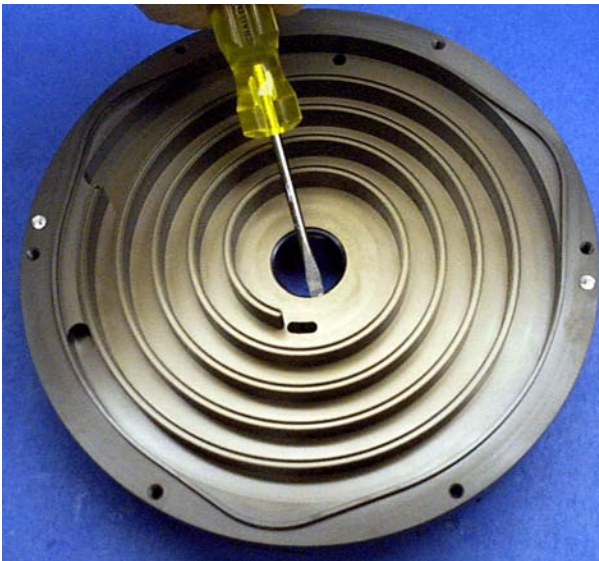

- 23. Allow the inboard housing to air cool until it can be handled with bare hands.
- 24. Remove and discard the shaft seal from the inboard housing.

## TriScroll 600 Disassembly (continued)



25. Carefully scrape with a chisel to loosen the tip seal dust from the orbiting plate, inboard and outboard housing. If seal debris is attached to the sides of the scroll walls, use a razor blade or Exacto knife to scrape this debris off.
26. Use dry compressed air to remove the tip seal debris.
27. Clean all the parts.

**NOTE**



*The use of an industrial detergent and water is recommended.*

28. Ensure that all parts are dry.

# Crankshaft Assembly

## Crankshaft Exploded View

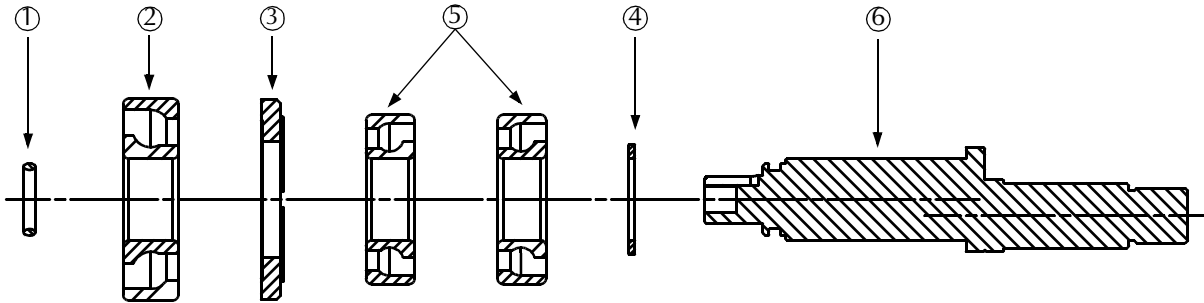

Callout	Part Number	Description	Quantity 302	Quantity 301
①	MK*	2-115 Viton <sup>®</sup> O-ring	1	1
②	MK*	7305WN SU Bearing	1	1
③	S4770001	VDS4 - Bearing Spacer	1	1
④	S4769001	Wave Washer - Crank	1	1
⑤	MK*	7205W SU Bearing	2	2
⑥	S4811001	VDS20 - Crankshaft	-	1

MK = Included in major maintenance kit

TSK = Included in tip seal kit

NSS = Not sold separately

## Assemble the Crankshaft

Tools required:

- ❑ Allen wrench
- ❑ Bearing pre-load tool
- ❑ Arbor press
- ❑ Krytox GPL 224 grease, included in maintenance kit



Locate the following parts shown in the photo to the left:

- ① Crankshaft
- ② Bearing spacer
- ③ 7305WN SU bearing, included in maintenance kit
- ④ 7205W SU bearings (2), included in maintenance kit
- ⑤ Wave washer-crank
- ⑥ O-ring, 2-115, included in maintenance kit
- ⑦ Seal spacer

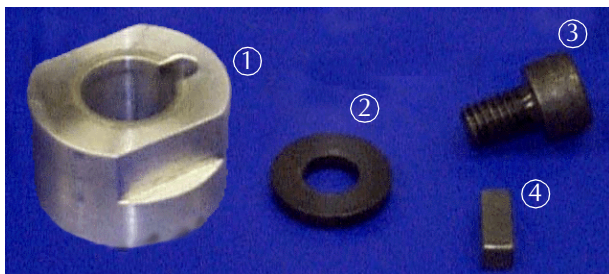

Locate the following parts in the photo to the left:

- ① Bearing pre-load tool
- ② Washer
- ③ M8x12 screw
- ④ 5x5x12 key



1. Install the wave washer onto the crankshaft.



## Assemble the Crankshaft (continued)



2. Install both 7205W SU bearings onto the crankshaft.

*Observe Proper Orientation*

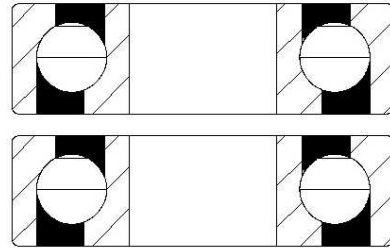

Toward Wave Washer



3. Install the bearing spacer onto the crankshaft.

*Observe Proper Orientation*



4. Install the 7305WN SU bearing onto the crankshaft.

*Observe Proper Orientation*



Toward Wave Washer

## Assemble the Crankshaft (continued)

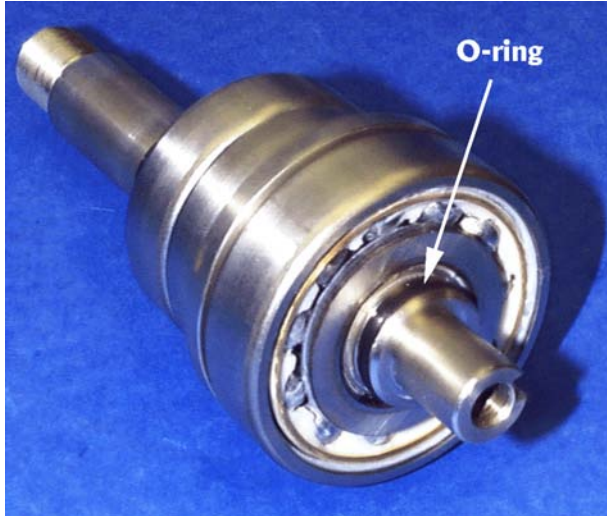

5. Lightly grease the O-ring and install it in the groove on the crankshaft.
6. Install the key in the slot.
7. Install the seal spacer over the O-ring.



8. Slide the bearing pre-load tool onto the crankshaft engaging the key.
9. Secure it with the M8x12 screw and washer.

# Inboard Housing Assembly

## Inboard Housing Exploded View

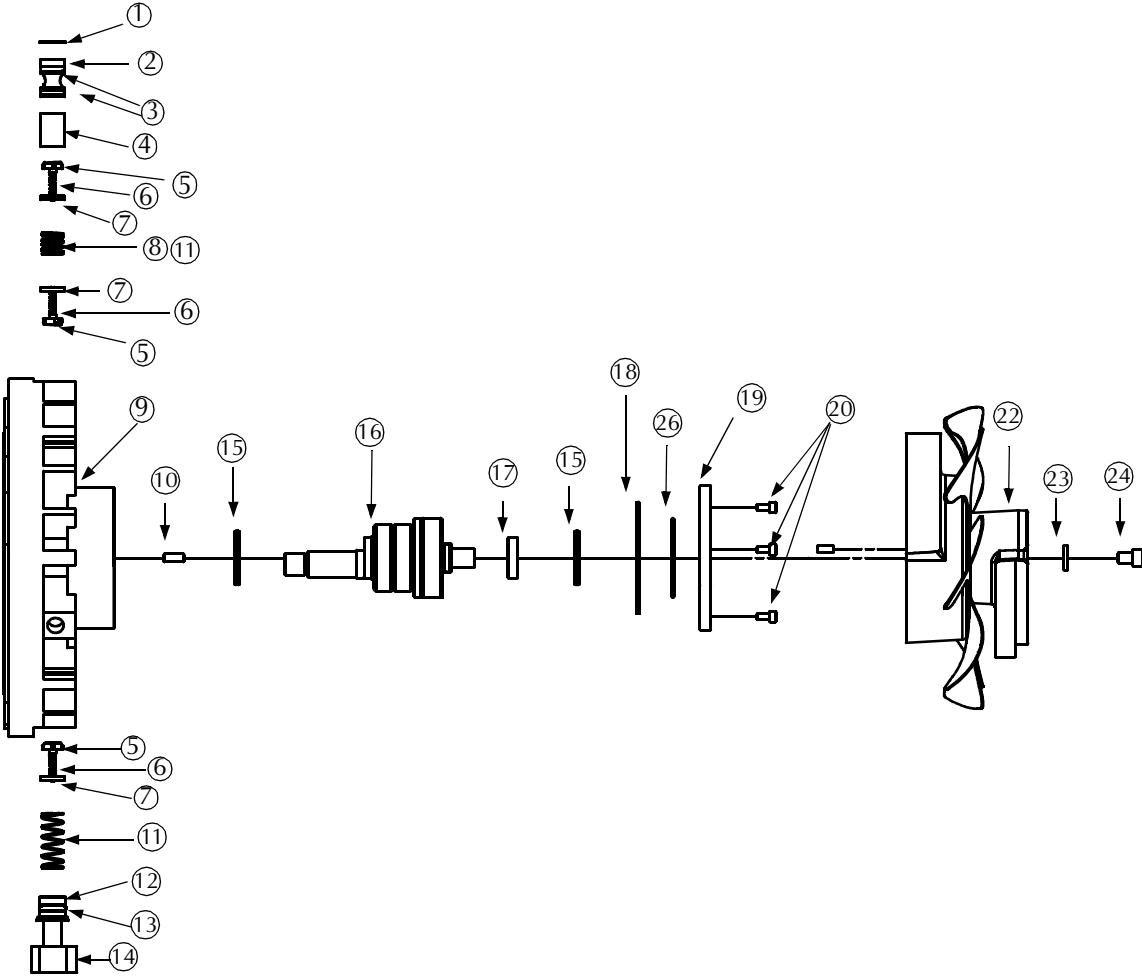

## TriScroll 600 Dry Scroll Vacuum Pump

Callout	Part Number	Description	Quantity	
			PTS06101-UNIV and PTS06103-UNIV	PTS06001UNIV and PTS06003UNIV
①	NSS*	Snap Ring N5000-75	1	1
②	S4835001	VDS20- Check Valve Plug	1	1
③	MK*	O-ring, Viton 2-113	2	2
④	S4837001	VDS20- Check Valve Spacer	1	1
⑤	S4723002	VDS20- Check Valve	2	3
⑥	660285574	Spring, S/S, .18 OD x .75 L x .014 Wire OD	2	3
⑦	S4820001	VDS20- Plunger Guide	2	3
⑧	660285540	Spring, S/S, .72 OD x .75 L x .055 Wire OD	1	1
⑨	NSS*	VDS20- Inboard Housing	1	1
⑩	NSS*	Dowel Pin, Steel, M6x16	2	2
⑪	660285545	Spring, S/S, .72 x 2.00 L x .055 Wire OD	-	1
⑫	S4806001	VDS20- Exhaust Fitting	1	1
⑬	MK*	O-ring, Viton 2-207	1	1
⑭	NSS*	Snap Ring, N5000-93	1	1
⑮	MK*	Shaft Seal, 32mm x 42mm x 4mm	2	2
⑯	NSS*	VDS20- Crankshaft Assembly	1	1
⑰	S4727001	VDS4- Seal Spacer	1	1
⑱	MK*	O-ring, Viton 2-152	1	1
⑲	S4712001	VDS4- Seal Housing	1	1
⑳	NSS*	Screw, Socket Head Cap, M5x10, Black Steel	3	3
㉒	NSS*	VDS20- Fan Assembly	1	1
㉓	NSS*	Washer, 11/32 x 3/4 x 1/8	1	1
㉔	NSS*	Screw, Socket Head Cap, M8x12, Black Steel	1	1
㉖	MK*	O-ring, Viton 2-140	1	1

MK = Included in major maintenance kit

TSK = Included in tip seal kit

NSS = Not sold separately

## Inboard Housing Assembly



### Insert the Shaft Seal

Tools required:

- Arbor press
- Seal installation tool
- Krytox GPL 224 grease

Locate the following parts shown in the photos to the left:

- ① Shaft seal, 32x42x4, included in maintenance kit
- ② Inboard housing



## Inboard Housing Assembly (continued)



1. Using Krytox GPL 224, grease the inner diameter of the shaft seal between its lips.

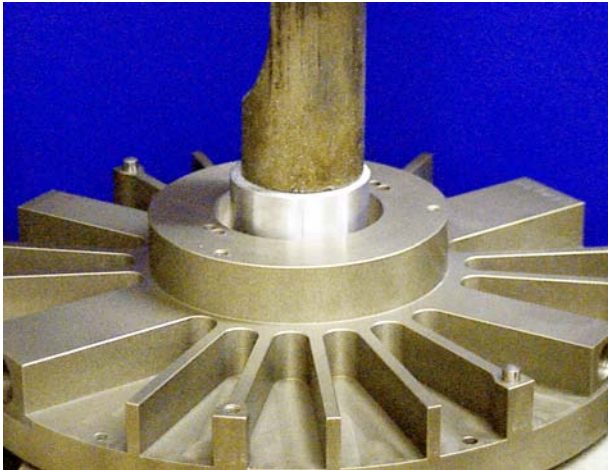

2. Using the seal insertion tool, press the shaft seal (32x42x4) into the bore of the inboard housing from the fin side.

*Observe Proper Orientation*



↓  
Into Bore

## Inboard Housing Assembly (continued)



### Insert the Crankshaft

Tools required:

- Cooling stand
- Gloves

Locate the following items:

- Crankshaft assembly
- Inboard housing

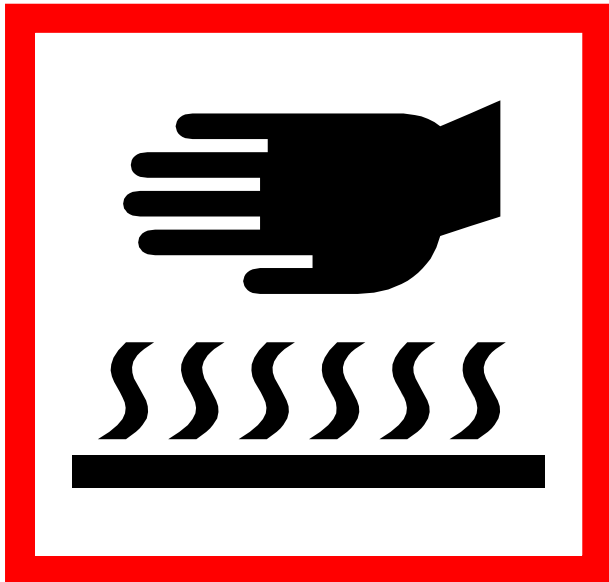

**WARNING** *This step requires the use of heat resistant gloves. Do not proceed without them!*



1. Heat the inboard housing for a minimum of 1 hour in a 350 °F oven.

## Inboard Housing Assembly (continued)



**WARNING** *Assembly is hot. Use heat resistant gloves for this step.*



2. Immediately after removing the inboard housing from oven, push the crankshaft assembly into the inboard housing, external threads first.



3. Place assembly in cooling stand and allow to air cool.

**CAUTION** *Be careful not to let crankshaft drop out.*





## Inboard Housing Assembly (continued)



### Insert the Seal Housing

Tools required:

- Allen wrench
- Seal installation tool
- Krytox GPL 224 grease
- Locite<sup>®</sup> 242

Locate the following parts shown in the photo on the left:

- ① Seal housing
- ② Shaft seal, 32x42x4, included in maintenance kit
- ③ M5x10 screw (3)
- ④ O-ring, 2-152, included in maintenance kit
- ⑤ O-ring, 2-140, included in maintenance kit

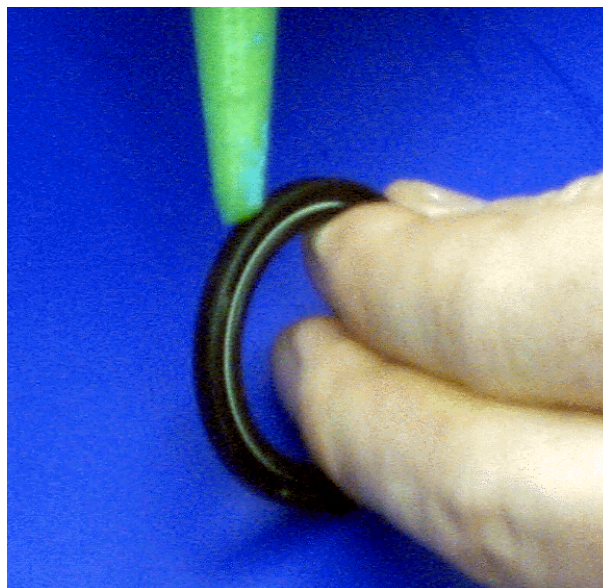

1. Spread a thin film of Locite<sup>®</sup> 242 onto the outer surface of the shaft seal, (32x42x4).

## Inboard Housing Assembly (continued)

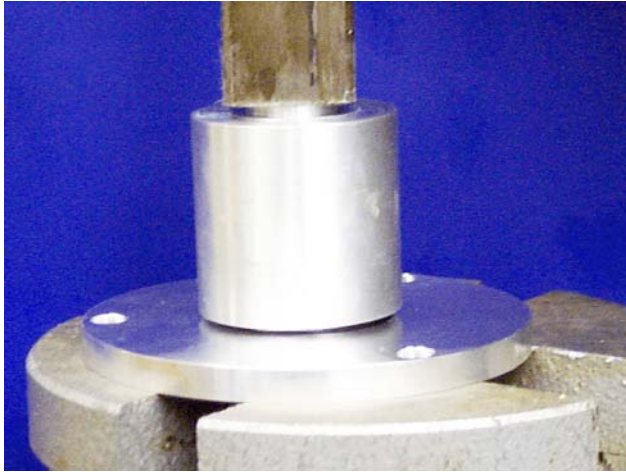

2. Press the shaft seal into the seal housing.

*Observe Proper Orientation*



3. Using Krytox GPL 224, grease the inner diameter of the shaft seal between lips.
4. Remove the screw, washer and bearing pre-load tool from crankshaft.
5. Lightly grease the 2-152 O-ring and insert it into the outer groove on the seal housing.
6. Lightly grease the 2-140 O-ring and insert it into the middle groove on the seal housing.

## Inboard Housing Assembly (continued)

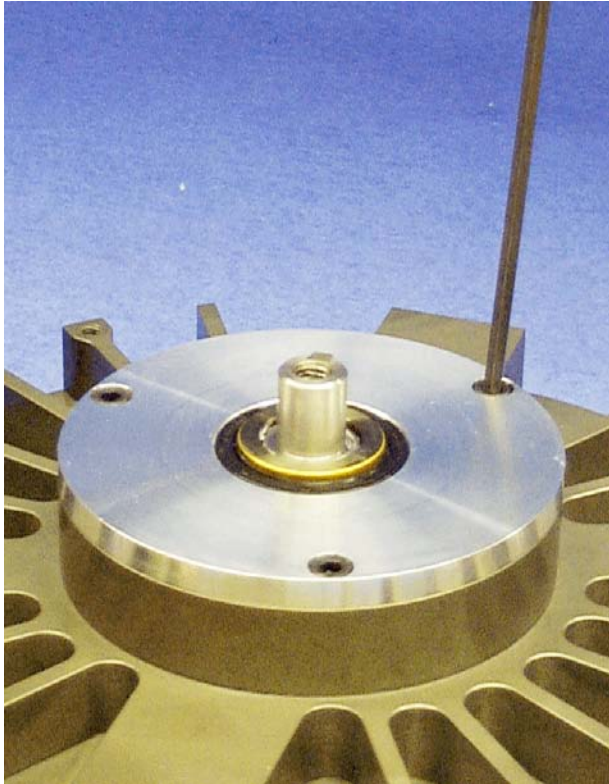

7. Secure the seal housing to the inboard housing with three M5x10 screws.
8. Tighten the screws to 75 in-lb.

**CAUTION**



*Avoid damage to the seal. Carefully rocking the seal housing onto the crankshaft will avoid damage to the seal during installation.*

9. Place the key into the slot in the crankshaft.

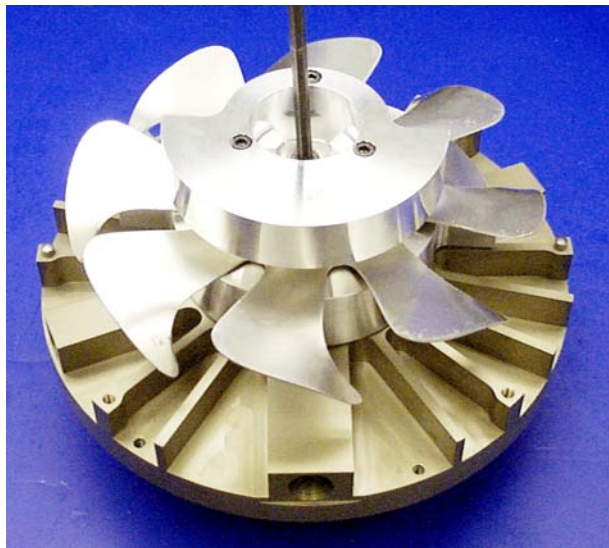

10. Slide the fan assembly onto the crankshaft, engaging the key and against the seal spacer.
11. Secure with the M8x12 screw and washer previously removed (see page 20).
12. Tighten screws to 250 in-lb.

## Inboard Housing Assembly (continued)

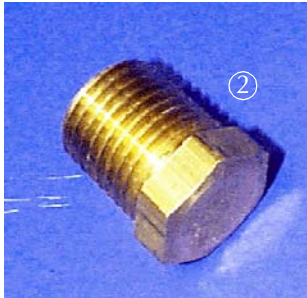
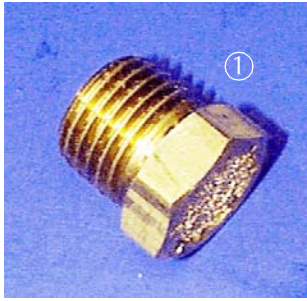

### Install the Vents and Plugs

Tools required:

- ❑ 14 mm wrench
- ❑ Loctite PST 567 pipe sealant, included in maintenance kit

Locate the following parts:

- ① Breather Vent, PTS06001UNIV and PTS06003UNIV, 1 required
- ② 1/4 NPT brass plug, PTS06001UNIV and PTS06003UNIV, 1 required  
PTS06101UNIV and PTS06103UNIV, 2 required

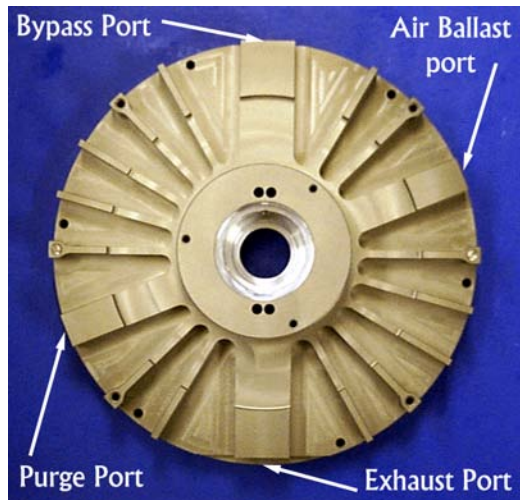
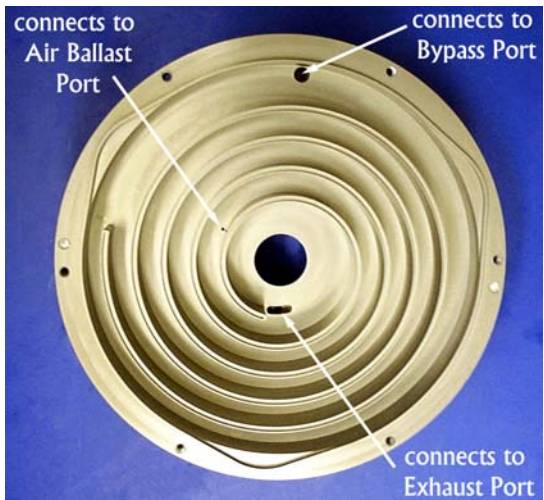

Inboard Housing Port Definition

## Inboard Housing Assembly (continued)

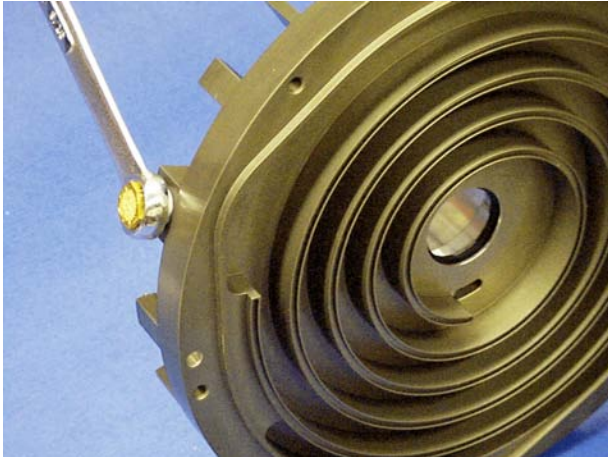

### **PTS06001UNIV and PTS06003UNIV only**

1. Apply a small amount of Loctite PST 567 pipe sealant to the first few threads of breather vent.
2. Insert the breather vent into the air ballast port and tighten.

### **PTS06101UNIV and PTS6103UNIV only**

1. Apply a small amount of Loctite PST 567 pipe sealant to the first few threads of 1/4 NPT brass plug.
2. Insert the plug into the air ballast port and tighten.

#### **NOTE**



*The photo shows a breather vent being installed into the air ballast port.*

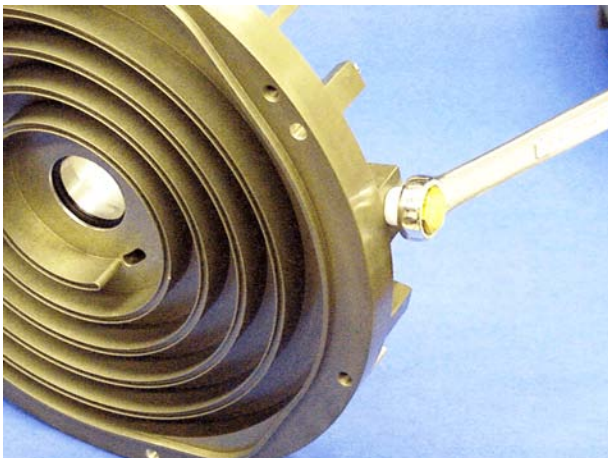

3. Apply a small amount of Loctite PST 567 pipe sealant to the first few threads of the second 1/4 NPT brass plug.
4. Insert the plug into the bearing purge port and tighten.

## Inboard Housing Assembly (continued)

### Exhaust Port Reassembly

**PTS06001UNIV and PTS06003UNIV only**

Tools required:

- ❑ Right angle snap ring pliers
- ❑ Krytox GPL 224 grease

Locate the following parts:

- ① Spring, large
- ② Plunger guide
- ③ Spring, small
- ④ Check valve assembly
- ⑤ Exhaust fitting
- ⑥ O-ring, 2-207, included in maintenance kit
- ⑦ Snap ring

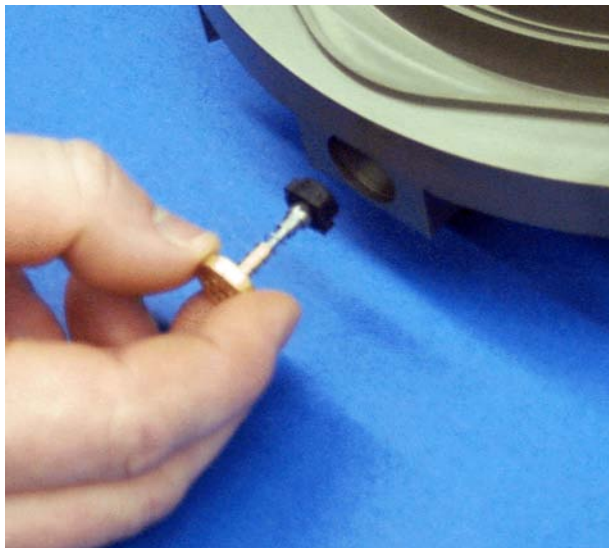
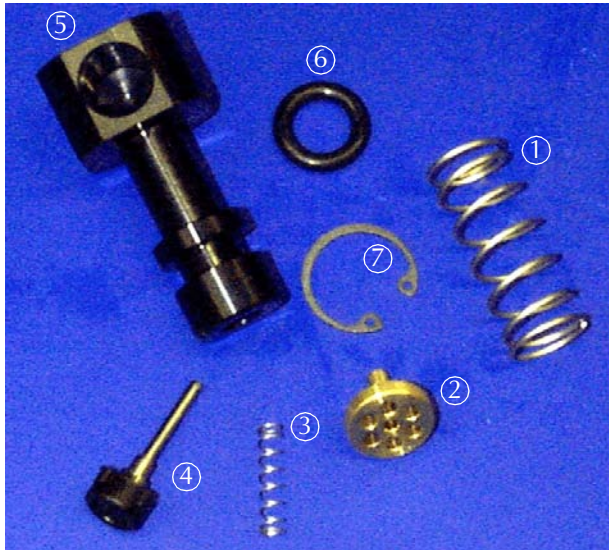

**PTS06001UNIV and PTS06003UNIV only**

1. Place the small spring onto the plunger guide.
2. Place the check valve onto the plunger guide.
3. Insert the check valve assembly, check valve first, into the exhaust port on the inboard housing.
4. Observe the proper orientation as shown in photo on the left.

**CAUTION** *Ensure that the check valve assembly remains on the plunger guide when inserted into the exhaust port.*



## Inboard Housing Assembly (continued)

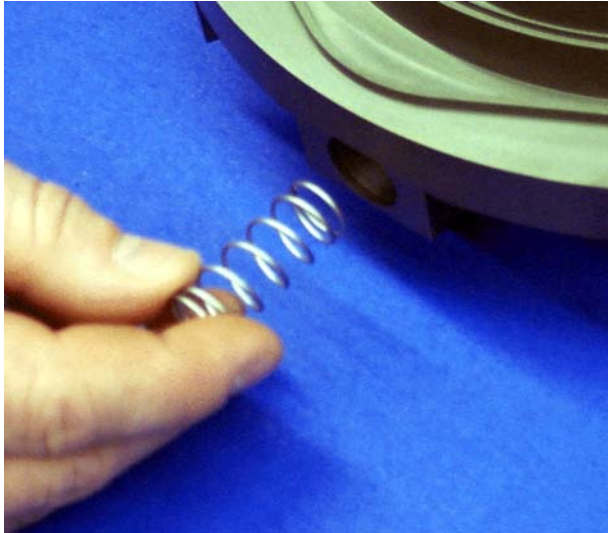

### PTS06001UNIV and PTS06003UNIV *only*

- ❑ Insert the larger spring into the exhaust port, pushing against the plunger guide.

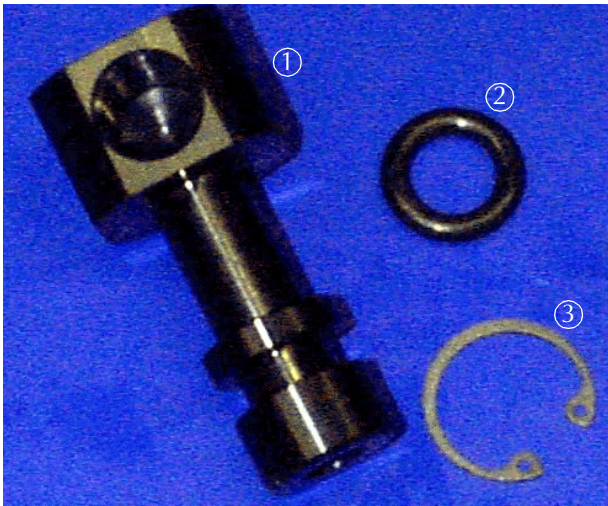

### PTS06101UNIV and PTS06103UNIV *only*

Tools required:

- ❑ Right angle snap ring pliers
- ❑ Krytox GPL 224 grease

Locate the following parts:

- ① Exhaust fitting
- ② O-ring, 2-207, included in maintenance kit
- ③ Snap ring



1. Lightly grease the O-ring, then install it in the groove on exhaust fitting.
2. Place the snap ring on the exhaust fitting. The snap ring must be bent slightly to fit around the exhaust fitting.

## Inboard Housing Assembly (continued)

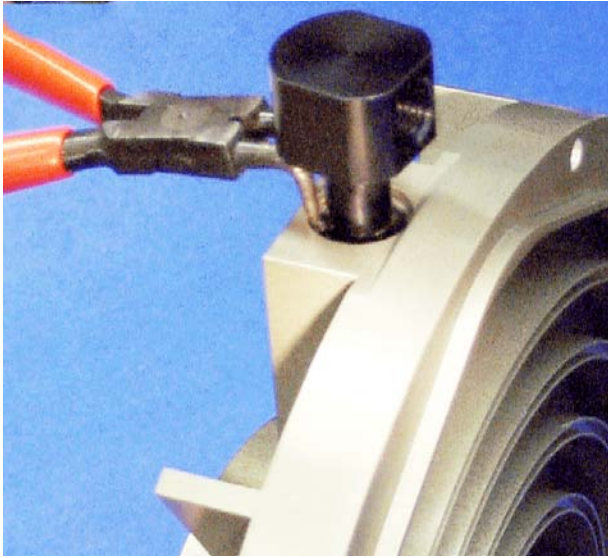

3. Push the exhaust fitting into the exhaust port and against the spring.
4. Secure it by inserting the snap ring into the groove in the exhaust port.



## Inboard Housing Assembly (continued)

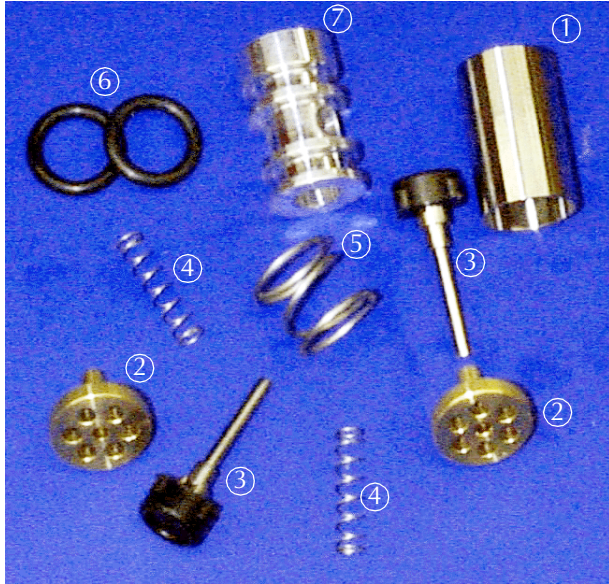

### Bypass Port Reassembly

Tools required:

- ❑ Right angle snap ring pliers
- ❑ Bypass plug insertion tool
- ❑ Krytox GPL 224 grease

Locate the following parts:

- ① Check valve spacer
- ② Plunger guide (2)
- ③ Check valve assembly (2)
- ④ Spring, small (2)
- ⑤ Spring, large
- ⑥ O-rings, 2-113 (2), included in maintenance kit
- ⑦ Check valve plug  
Snap ring (not shown)



5. Place the small spring onto the plunger guide.
6. Place the check valve onto the plunger guide.
7. Insert the check valve assembly, check valve first, into the exhaust port on the inboard housing.
8. Observe the proper orientation as shown in the photo on the left.

**CAUTION** *Ensure that the check valve assembly remains on the plunger guide when inserted into the bypass port.*



## Inboard Housing Assembly (continued)

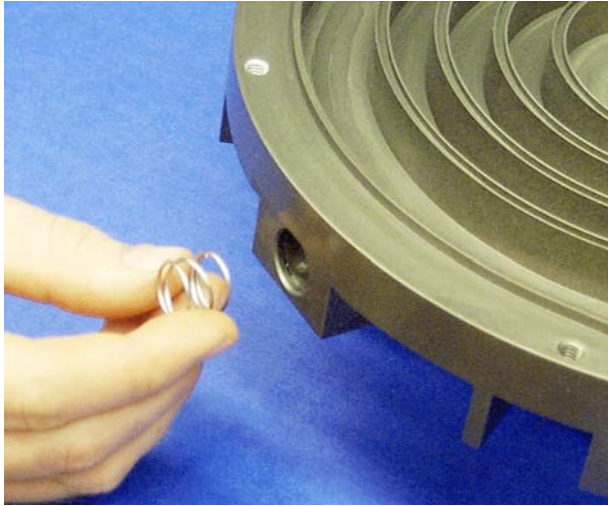

9. Insert the large spring into the bypass port, pushing against the plunger guide.

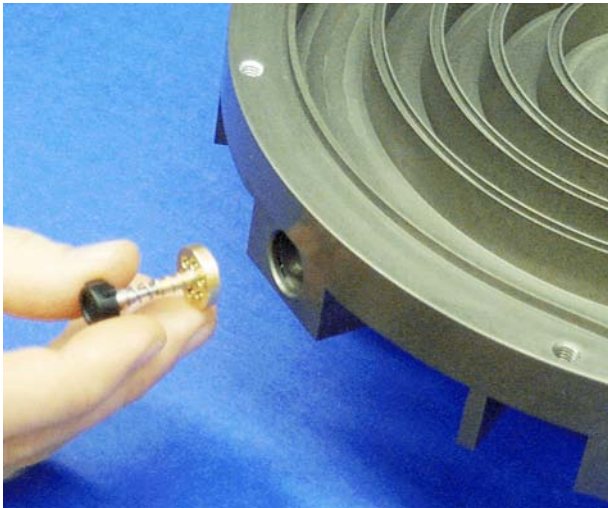

10. Place the small spring onto the plunger guide.
11. Place the check valve onto the plunger guide.
12. Insert the check valve assembly, plunger guide first, into the exhaust port on the inboard housing.
13. Observe the proper orientation as shown in the photo on the left.

**CAUTION** *Ensure that the check valve assembly remains on the plunger guide when inserted into the bypass port.*



## Inboard Housing Assembly (continued)

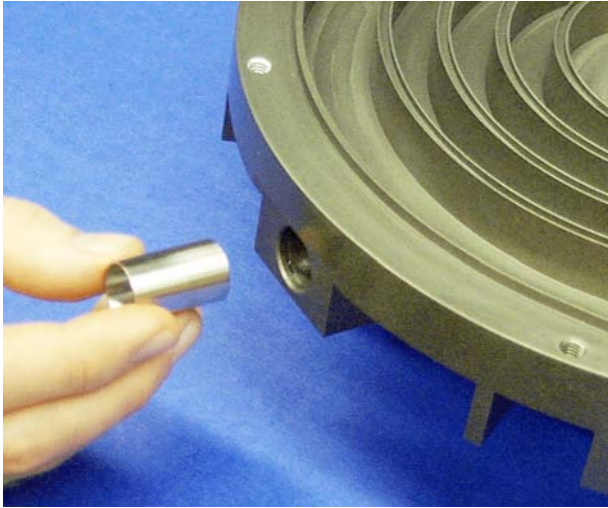

14. Insert the check valve spacer into the bypass port around the check valve assembly until it pushes against the plunger guide.

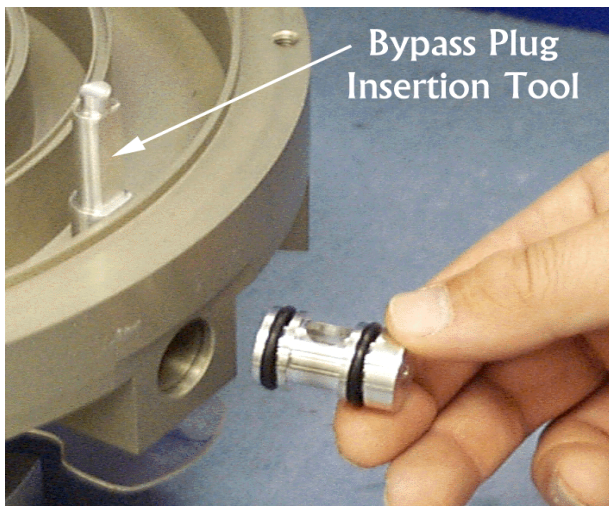

15. Lightly grease the two O-rings, 2-113, and install them in the grooves on the check valve plug.
16. Insert the bypass plug insertion tool into the guide hole above the post.

**CAUTION** *Be careful not to cut the O-ring on the 3/8" diameter cross-port in the bypass of the inboard housing. Use the bypass plug insertion tool.*



17. Insert the check valve plug into bypass port against the check valve spacer.
18. Observe the proper orientation as shown in photo on the left.

## Inboard Housing Assembly (continued)

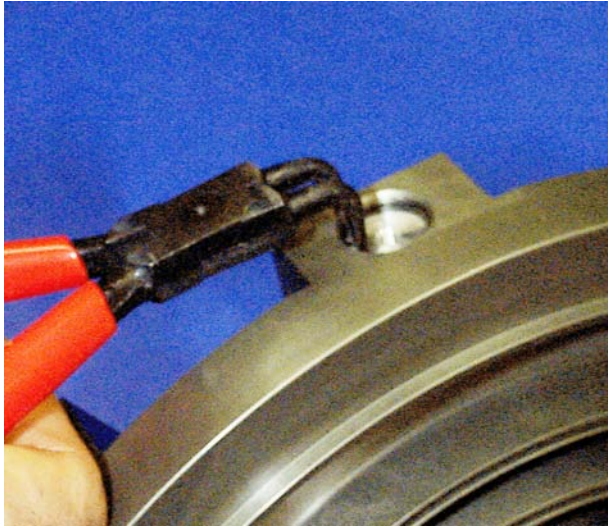

19. Secure the check valve plug by inserting the snap ring into the bypass port groove.

# Orbiting Plate Assembly

## Orbiting Plate Exploded View

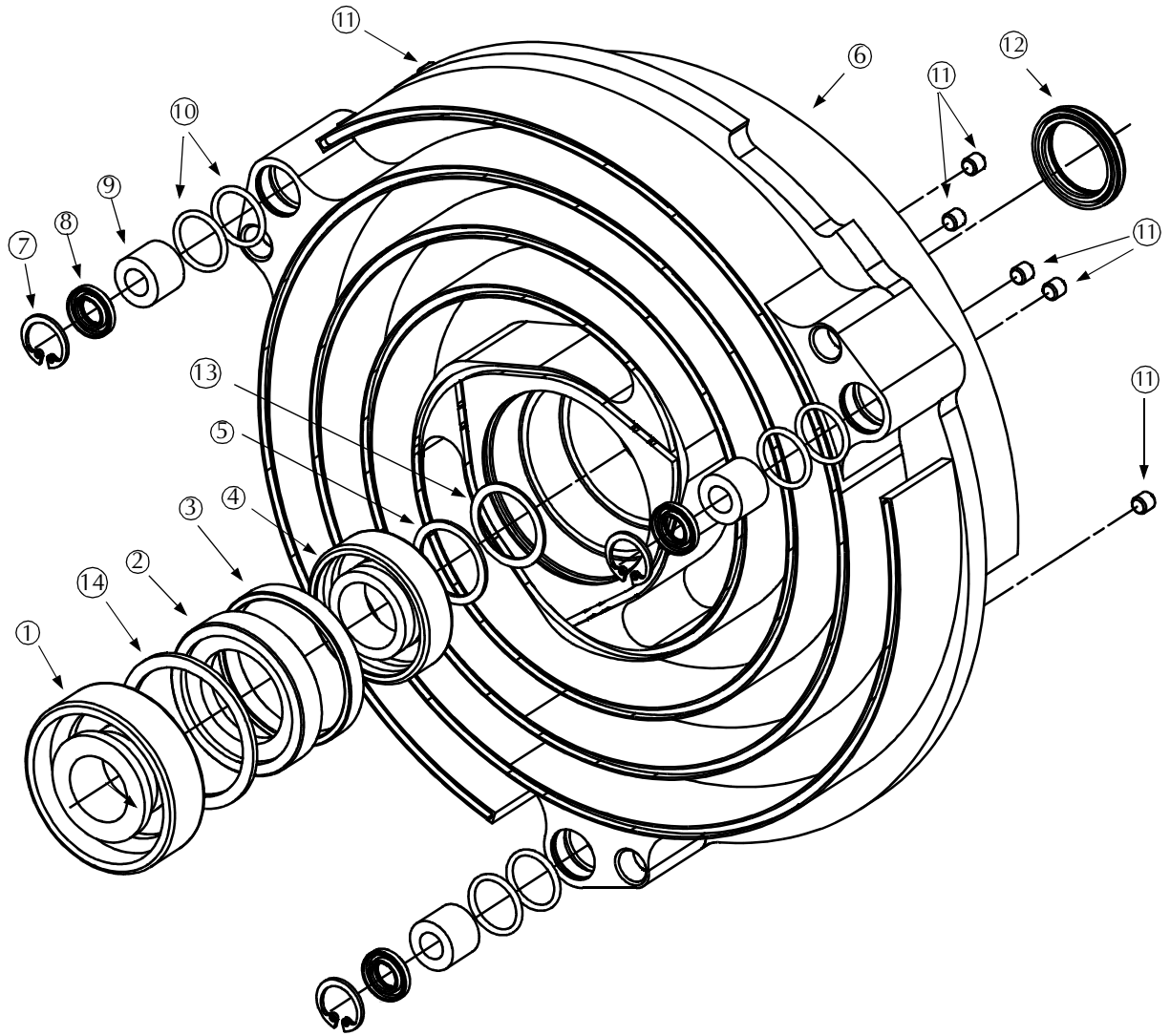

## TriScroll 600 Dry Scroll Vacuum Pump

---

Callout	Part Number	Description	Quantity
①	MK*	7304WN SU Bearing	1
②	S4829001	VDS20- Orbiting Spacer	1
③	MK*	VDS4- Nylon Sleeve	1
④	MK*	J9104P x1527 Bearing	1
⑤	S4758001	Wave Washer - Nested	1
⑥	NSS*	VDS20- Center Orbiting Plate	1
⑦	NSS*	DIN472-0150 Snap Ring	3
⑧	MK*	Shaft Seal, 8x15x3	3
⑨	MK*	NK 8/12 Needle Bearing	3
⑩	MK*	2-016 Viton O-ring	6
⑪	NSS*	M5x5 Set Screw	6
⑫	MK*	Shaft Seal 22x30x4	1
⑬	S4816001	Steel Washer	1
⑭	S4857001	Wave Washer	1

MK = Included in major maintenance kit

TSK = Included in tip seal kit

NSS = Not sold separately

## Orbiting Plate Assembly



### Install the Bearing Assembly

Tools required:

- ❑ Heat resistant gloves
- ❑ Orbiting plate fixture

Locate the following parts:

- ① 7304WN SU bearing, included in maintenance kit
  - ② J9104P bearing, included in maintenance kit
  - ③ Wave Washer
  - ④ Orbiting spacer
  - ⑤ Nylon sleeve, included in maintenance kit
- Orbiting plate (not shown in photo)

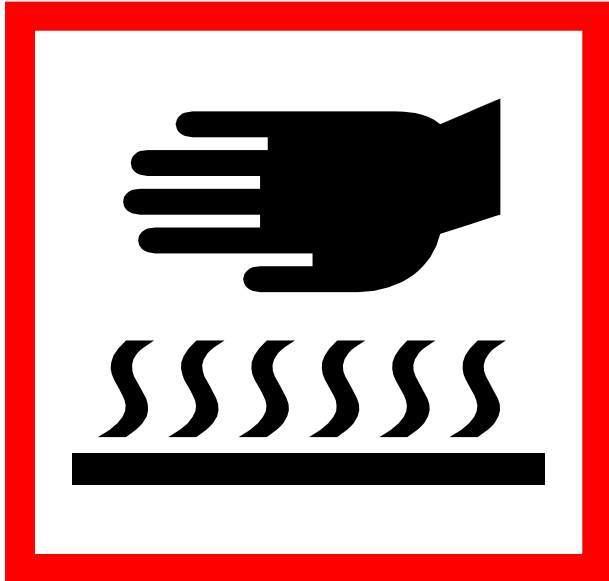

**WARNING** *This step requires the use of heat resistant gloves. Do not proceed without them!*



1. Heat the orbiting plate for a minimum of 1 hour in 350 °F oven. While the orbiting plate is heating, prepare the bearing fixture. The posts of the orbiting plate bearing fixture have two different sized bottom disks. Use the end that has the smaller of the bottom disks.
2. Remove the nut and the seal with the larger bottom disk from the fixture in preparation for sealing the assembly.

## Orbiting Plate Assembly (continued)



**WARNING** *Assembly is hot, use heat resistant gloves.*



3. Immediately after removing the orbiting plate from the oven, insert the J9104P bearing, sealed side toward the bore.



**WARNING** *Assembly is hot, use heat resistant gloves.*



4. Immediately, and while the orbiting plate is still hot, drop the nylon sleeve into bore and around the J9104P bearing.



## Orbiting Plate Assembly (continued)



5. Drop the orbiting spacer on top of the nylon sleeve.

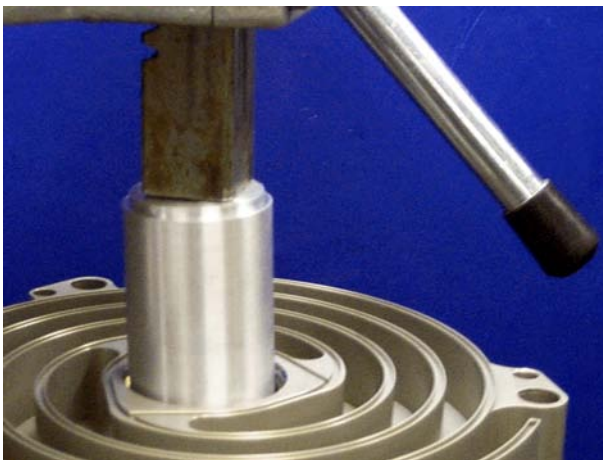

**WARNING** *Assembly is hot, use heat resistant gloves.*



6. Using an arbor press, press against the orbiting spacer until it is flush with the open end of the J9104P bearing.

## Orbiting Plate Assembly (continued)

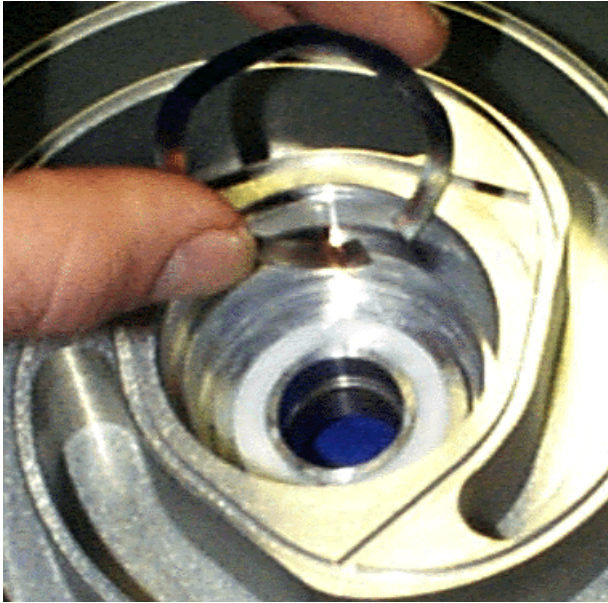

**WARNING** *Assembly is hot, use heat resistant gloves.*



7. Immediately, while orbiting plate is still hot, drop the wave washer on top of the orbiting spacer.



8. Immediately insert the 7304WN SU bearing into the bore and against the orbiting spacer.

*Observe Proper Orientation*



↓  
Toward Bore

## Orbiting Plate Assembly (continued)



9. Immediately, while the orbiting plate is still hot, place the orbiting plate onto the post of the orbiting plate fixture that has the larger bottom disk.
10. Place the large washer and the locking nut onto the post and tighten the entire assembly.

**WARNING** *Assembly is hot, use heat resistant gloves.*



11. Allow the orbiting plate to air cool completely.
12. Once it is cooled, remove the orbiting plate from the orbiting plate fixture.
13. Replace the washer and tighten the nut onto the orbiting plate fixture.

## Orbiting Plate Assembly (continued)

### Install the Wave Washer and Shaft Seal

Tools required:

- Allen wrench
- Arbor press
- Seal installation tool
- Krytox GPL 224 grease
- Loctite 242

Locate the following parts shown in the photo:

- ① Steel Washer
- ② M5x5 set screw (6)
- ③ Wave washer - nested
- ④ Shaft seal, 22x30x4, included in maintenance kit

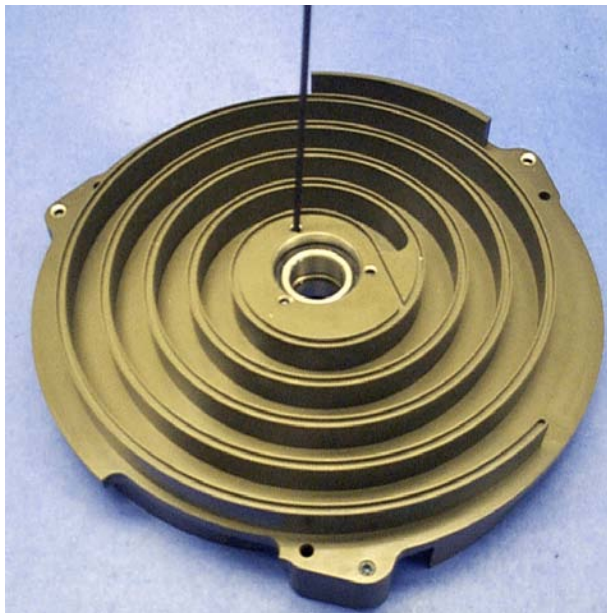
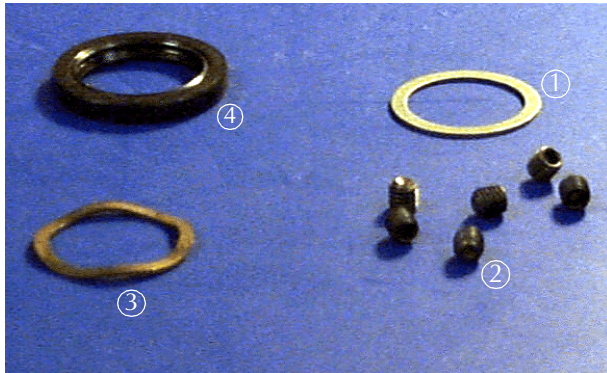

1. Apply a small amount of Loctite 242 to the lower threads of the six M5x5 screws, then install one screw into each threaded hole in the orbiting plate.
2. Tighten the screws until they are slightly below the surface.

## Orbiting Plate Assembly (continued)



3. Install the wave washer into the orbiting plate.



4. Install the steel washer against the wave washer.

## Orbiting Plate Assembly (continued)

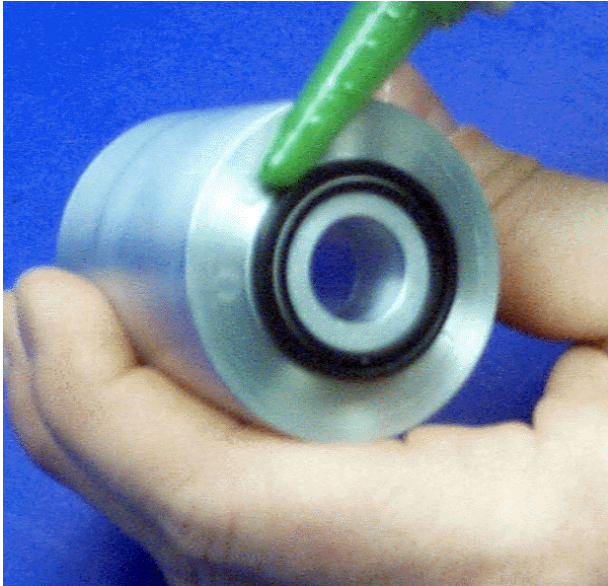

5. Place the shaft seal onto the shaft seal installation tool.
6. Apply a thin film of Loctite 242 to the outer edge of the shaft seal.

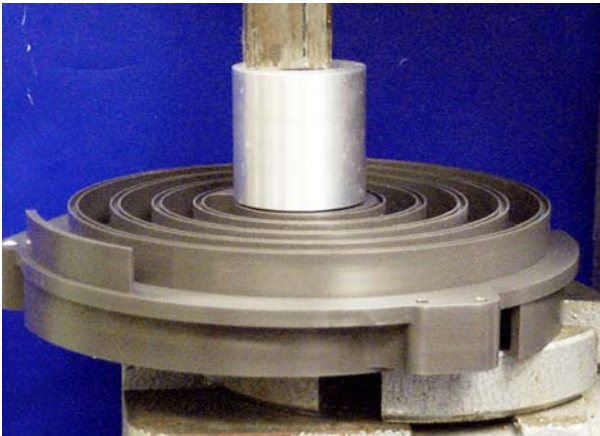

7. Using the shaft seal installation tool, press the shaft seal into the orbiting plate.

*Observe Proper Orientation*



Toward Bore

8. Apply Krytox GPL 224 to the inner diameter of the seal between the lips.

## Orbiting Plate Assembly (continued)



### Install the Needle Bearings

Tools required:

- ❑ Right angled snap ring pliers
- ❑ Krytox GPL 224 grease

Locate the following part shown in the photo on the left:

Orbiting plate



Locate the following parts shown in the photo on the left:

- ① Snap rings (3)
- ② O-rings, 2-016 (6), included in maintenance kit
- ③ Needle bearing (3), included in maintenance kit
- ④ Shaft seals, 8x15x3 (3), included in maintenance kit

## Orbiting Plate Assembly (continued)



1. Lightly grease the O-rings, then insert them into the two grooves in each of three sync crank bearing bores in the orbiting plate.
2. Push one needle bearing into each bearing bore.

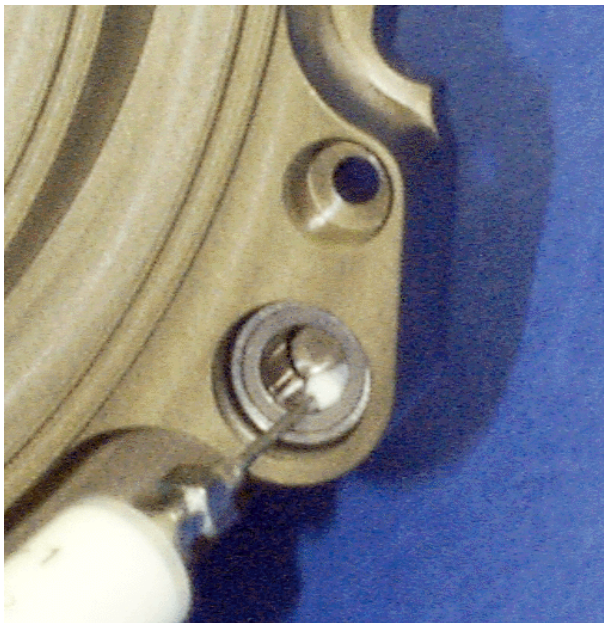

3. Squeeze a 1/4" diameter dot of Krytox into each of the three needle bearings.
4. Smear grease over all the needles.



## Orbiting Plate Assembly (continued)



5. Coat the lips of the three shaft seals with grease.
6. Insert one shaft seal into each bore against the needle bearing.

*Observe Proper Orientation*

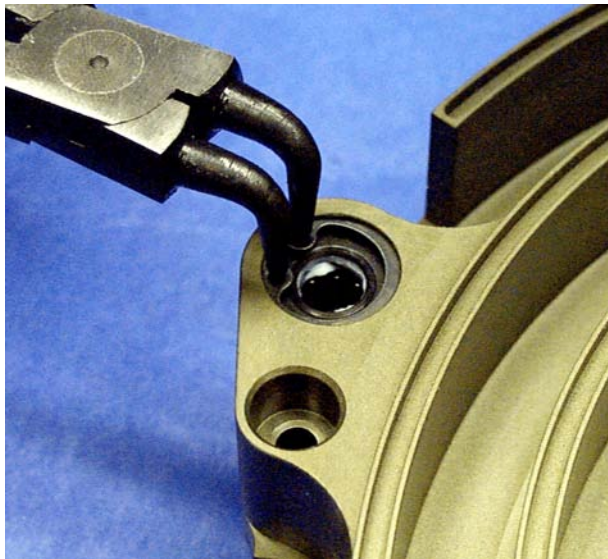
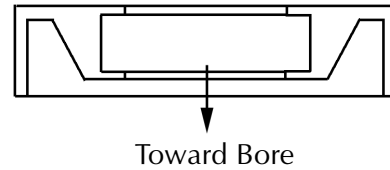

7. Secure the sync crank by inserting the snap ring into the bearing bore groove.

## TriScroll 600 Dry Scroll Vacuum Pump

---

*This page intentionally left blank.*



## TriScroll 600 Dry Scroll Vacuum Pump

Callout	Part Number	Description	Quantity			
			PTS06103UNIV	PTS06101UNIV	PTS06003UNIV	PTS06001UNIV
①	S4744001	TriScroll Pump Front Label	1	1	1	1
②	NSS*	M5x22 SHCS, Black Steel	6	6	6	6
③	NSS*	M5x16 SHCS, Black Steel	5	5	5	5
④	S4703001	VDS4 - Outboard Cover	1	1	1	1
⑤	MK*	2-157 Viton O-ring	1	1	1	1
⑥	S4805001	VDS20 - Cowling	1	1	1	1
⑦	NSS*	N5000-75 Snap Ring	3	3	3	3
⑩	MK*	VDS20- Sync Crank Assembly	3	3	3	3
⑪	NSS*	M6x55 SHCS, Black Steel	6	6	6	6
⑫	NSS*	VDS20 - Outboard Housing	1	1	1	1
⑬	MK*	2-127 Viton O-ring	1	1	1	1
⑭	S4809001	VDS20-NW40 Intake Fitting	1	1	1	1
⑮	S4824001	VDS20 - Intake Screen	1	1	1	1
⑯	NSS*	N5000-137 Snap Ring	1	1	1	1
⑰	S4808001	VDS20 - Intake Clamp	1	1	1	1
⑱	NSS*	M6x16 Steel Dowel Pin	2	2	2	2

MK = Included in major maintenance kit

TSK = Included in tip seal kit

NSS = Not sold separately

## TriScroll 600 Dry Scroll Vacuum Pump

Callout	Part Number	Description	Quantity			
			PTS06103UNIV	PTS06101UNIV	PTS06003UNIV	PTS06001UNIV
⑲	TSK* & MK*	VDS4 - Tip Seal	1	1	1	1
⑳	NSS*	N5000-225 Snap Ring	1	1	1	1
㉑	S4819001	VDS20 - Orbiting Cup	1	1	1	1
㉒	TSK* & MK*	2-137 Viton O-ring	1	1	1	1
㉓	617919032	Spieth Locknut	1	1	1	1
㉔	NSS*	VDS20 - Orbiting Plate Assembly	1	1	1	1
㉕	TSK* & MK*	2-273 Viton O-ring	1	1	1	1
㉖	NSS*	TS600 Inboard Assembly	-	-	1	1
㉗	642971040	Breather Vent	-	-	1	1
㉘	NSS*	1/4 Brass Plug	2	2	1	1
㉙	670086120	Spider, L075 Open	1	1	1	1
㉚	622471058	Coupling, L075 W/15 mm Key	1	1	1	1
㉛	NSS*	M8x16 SHCS	4	4	4	4
㉜	NSS*	M6x16 SHCS	4	4	4	4
㉝	611810025	M8x1.25 Eye Bolt	1	1	1	1
㉞	S4841001	VDS20 - Single Phase Motor	-	1	-	1
㉟	S4842001	VDS20-1 HP 3 Phase Motor	1	-	1	-
㊱	S4804001	VDS20 - Transition Frame	1	1	1	1
㊲	648099055	Rubber Foot	4	4	4	4

MK = Included in major maintenance kit

TSK = Included in tip seal kit

NSS = Not sold separately

## TriScroll 600 Dry Scroll Vacuum Pump

Callout	Part Number	Description	Quantity			
			PTS06103UNIV	PTS06101UNIV	PTS06003UNIV	PTS06001UNIV
③⑨	NSS*	M6x12 Socket Head Button Screw	4	4	4	4
④①	NSS*	Arrow Decal	1	1	1	1
④②	660288013	SSB-0075, Wave Spring	3	3	3	3
④③	S4807001	VDS20-NW25 Pipe Fitting	1	1	1	1
④④	NSS*	TS610 Inboard Assembly	1	1	-	-

MK = Included in major maintenance kit

TSK = Included in tip seal kit

NSS = Not sold separately

## Final Assembly

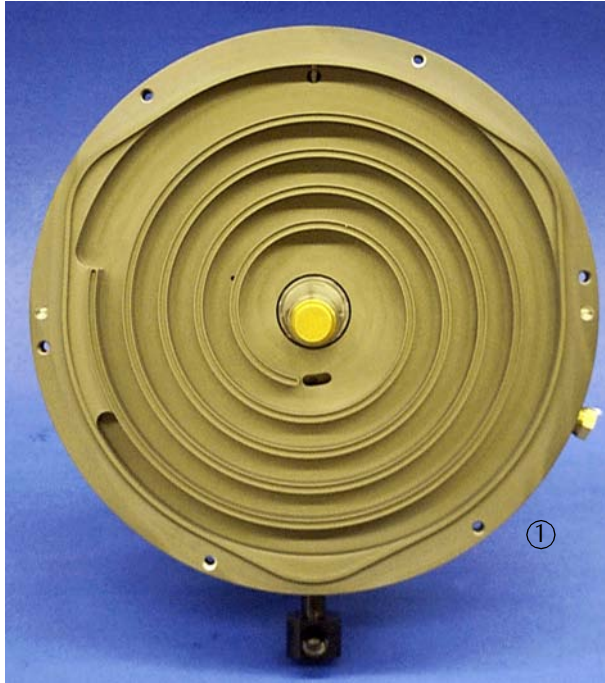

Tools required:

- Allen wrench

Locate the following items:

- ① Inboard housing assembly
- ② Spider coupling
- ③ M6x16 screws (4)

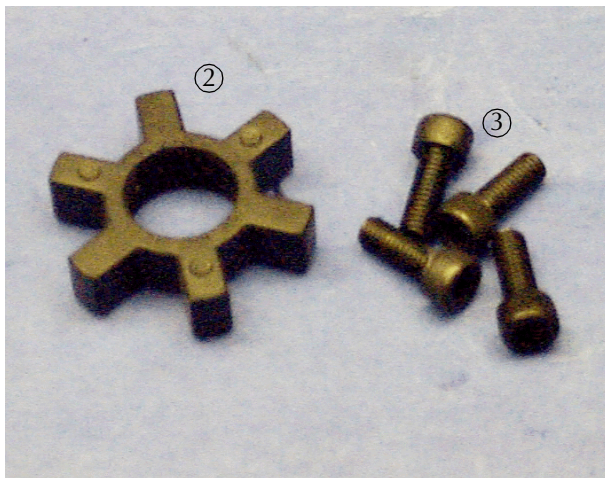

## Final Assembly (continued)



1. Insert the spider into the motor coupling.

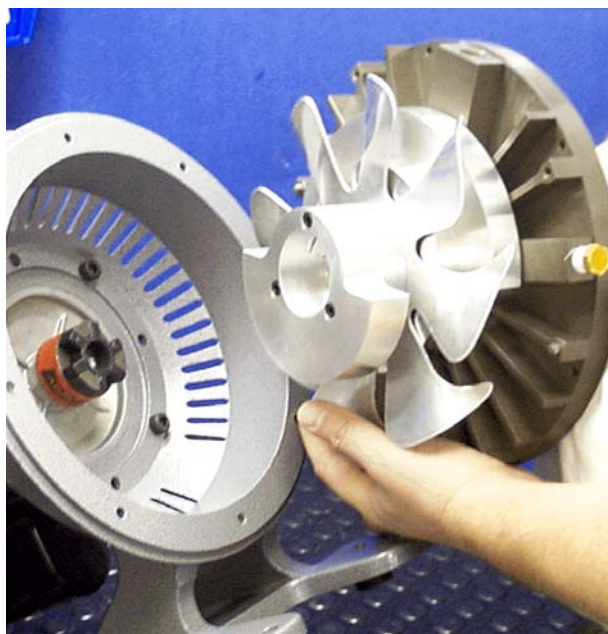

2. Install the inboard assembly into the TriScroll frame, aligning the fingers on the fan assembly with the fingers on the coupling.

Ensure that the dowel pins fit properly on the mating holes in frame.

**NOTE**



*Exhaust fitting located in the downward position.*



### Final Assembly (continued)

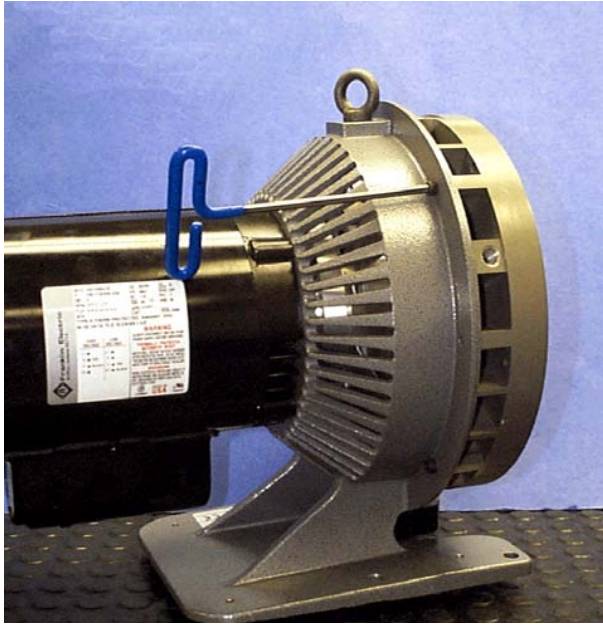

3. Secure the inboard assembly to the frame with the four M6x16 screws.

## Final Assembly (continued)



### Install the Orbiting Plate

Tool required:

- Locking nut wrench
- Snap ring pliers
- Allen wrench
- Depth Gauge
- Krytox GPL 224 grease

Locate the following parts:

- Orbiting plate assembly

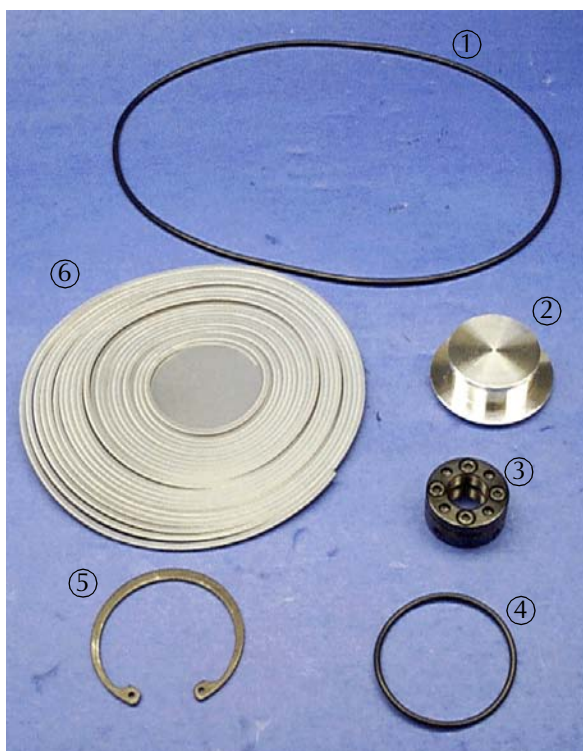

Locate the following parts:

- ① O-ring, large, 2-273, included in maintenance kit
- ② Orbiting cup
- ③ Locking nut
- ④ O-ring, small, 2-137, included in maintenance kit
- ⑤ Snap ring
- ⑥ Tip seals, included in maintenance kit

## Final Assembly (continued)



1. Slide the orbiting plate assembly onto the crankshaft and into the inboard housing.

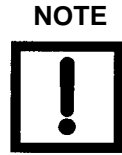

**NOTE** *The balance fin on the orbiting plate should be oriented in the downward position when sliding the orbiting plate onto the crankshaft and into the inboard housing.*

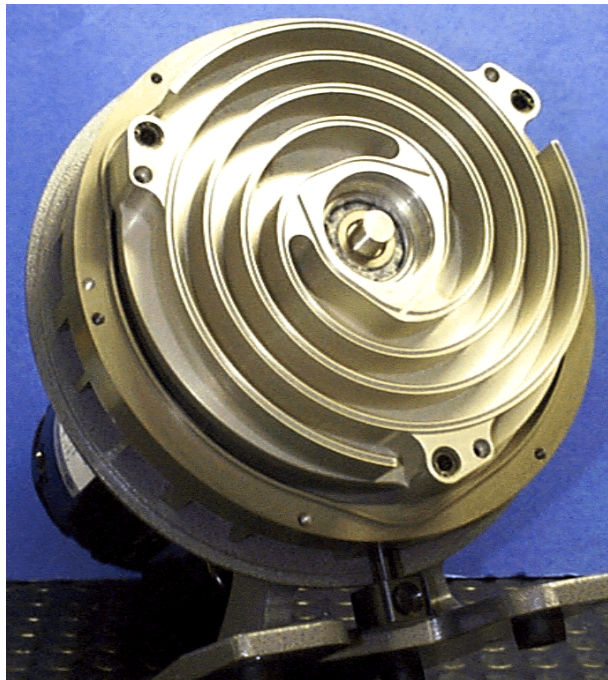

## Final Assembly (continued)

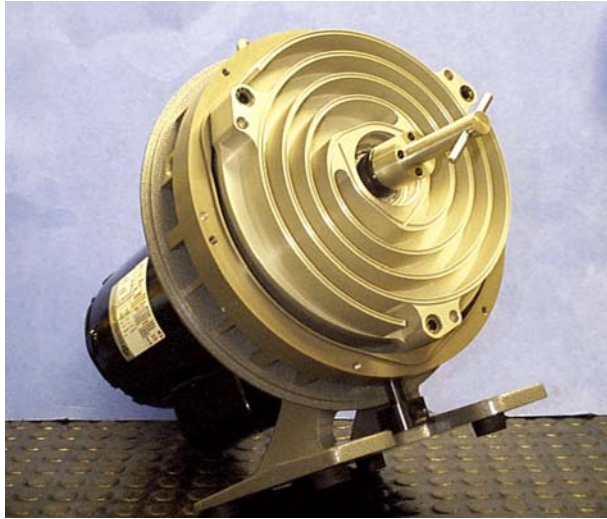

2. Remove the four M4x12 locking screws from the locking nut.
3. Secure the orbiting plate with the locking nut.
4. Tighten snugly with locking nut wrench.

**CAUTION** *Do not overtighten.  
Overtightening can cause bearing damage.*

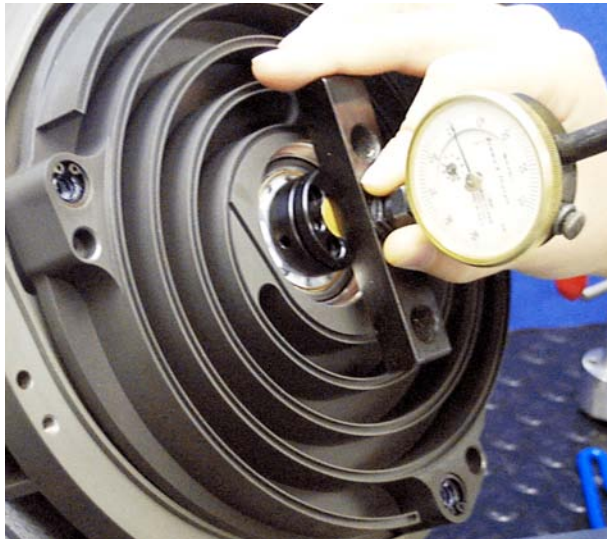

5. Measure the distance from the face of the locking nut to the crankshaft end using the depth gauge.
6. Note and record the distance.

Date \_\_\_\_\_  
Distance \_\_\_\_\_

7. Disassemble the locking nut and orbiting plate assembly from the inboard assembly.

## Final Assembly (continued)

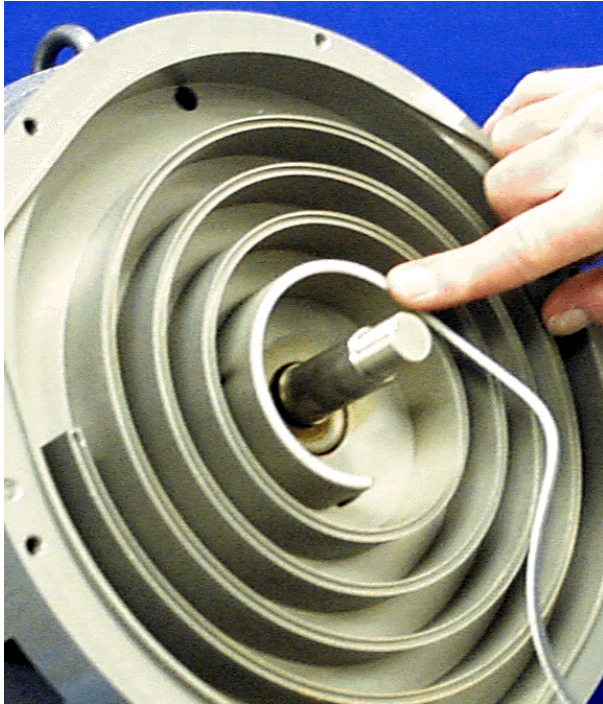

8. Insert the tip seal into the scroll tip grooves on the inboard housing.
9. Cut to the correct length at the end of each groove.



10. Insert the tip seal into the scroll tip grooves on the inboard side of orbiting plate.
11. Cut to the correct length at the end of each groove.

### Final Assembly (continued)

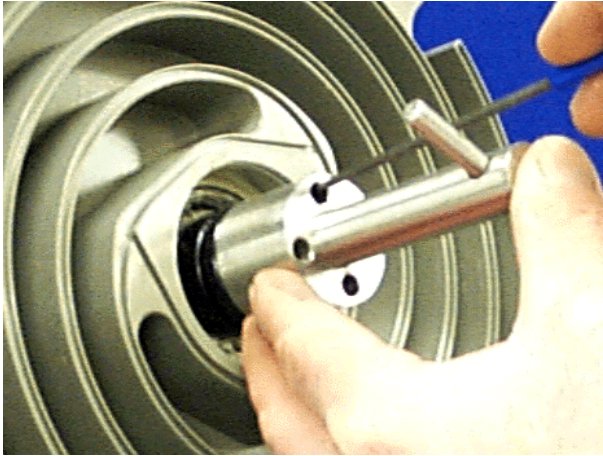

12. Repeat steps 1 through 3 to reassemble the orbiting plate assembly and locking nut on the inboard assembly.
13. Using the locking nut wrench, tighten the locking nut until the distance from the face of the locking nut to the crankshaft end equals the distance noted in step 6 on page 74, plus .008 inch.
14. Secure the locking nut by installing the four M4x12 locking screws.
15. Use the locking nut wrench to maintain the locking nut position while tightening the locking screws.

**CAUTION** *Make sure that the locking nut does not rotate relative to the crankshaft.*



16. Ensure that all four locking screws are tightened to at least 40 in-lb.
17. Insert the tip seal in the scroll tip grooves on the orbiting plate.
18. Cut to length at the end of each groove.



## Final Assembly (continued)



19. Lightly grease the O-ring and place it onto the orbiting cup.



20. Insert the orbiting cup into the center of the orbiting plate.

21. Push the orbiting cup into place and hold it securely while engaging the snap ring.

### CAUTION



*If the orbiting cup slips out prior to installing the snap ring, remove the orbiting cup, re-install the O-ring and re-insert the orbiting cup into the orbiting plate.*

*Use care not to shear the O-ring while pushing the orbiting cup into the orbiting plate.*

## Final Assembly (continued)



22. Lightly grease the large O-ring and install it around the lip of the inboard housing.



## Final Assembly (continued)



### Install the Sync Crank and Tip Seals into the Outboard Housing

Tools required:

- ❑ Allen wrench
- ❑ Krytox GPL 224 grease

Locate the following parts shown in the photo at the left:

- ① Wave washer (3)
- ② Snap rings (3)
- ③ Sync crank assembly (3), included in maintenance kit



Locate the following items shown in the photo to the left:

- ① Tip seal, included in maintenance kit
- ② M6x55 screws (6)

Outboard housing (not shown in photo)

### Final Assembly (continued)

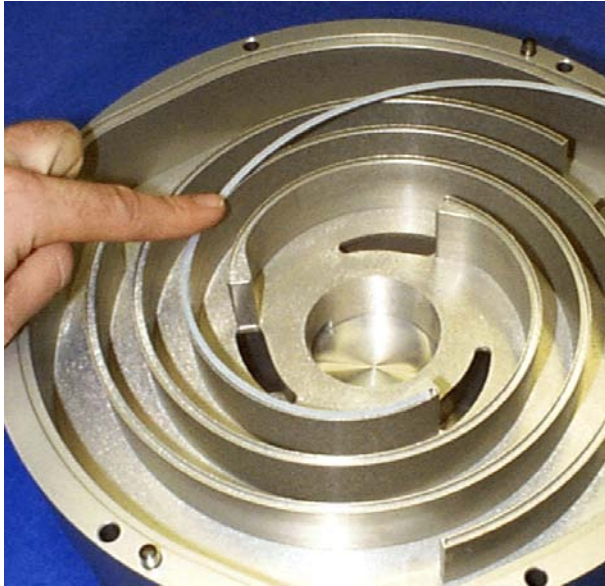

1. Insert the tip seals in the grooves on the outboard housing.
2. Cut to length at the end of grooves.

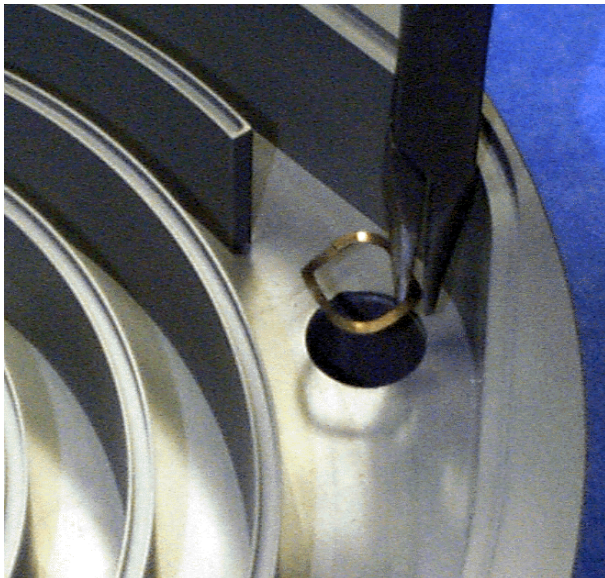

3. Insert a wave washer into each sync crank bore in the outboard housing.

## Final Assembly (continued)

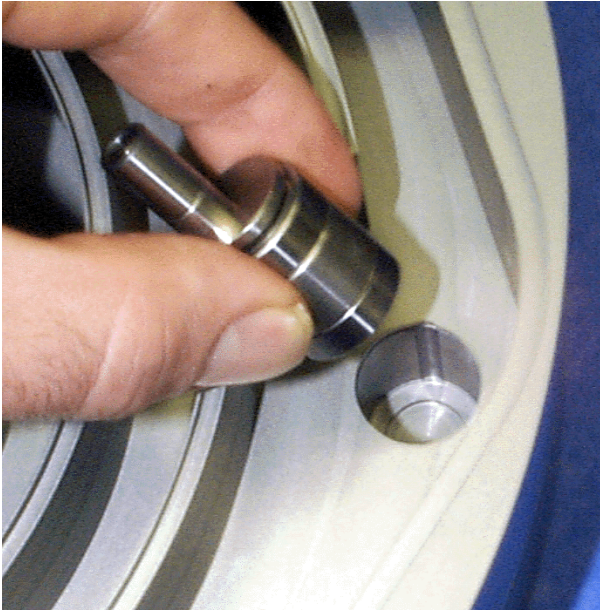

4. Insert a sync crank into each bore.



5. Secure the sync crank by inserting the snap ring into the bore.

### Final Assembly (continued)

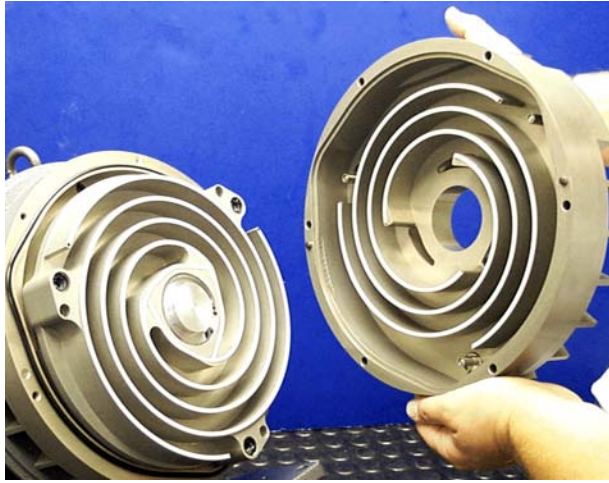

#### Install the Outboard Housing

1. Install the outboard housing over the orbiting plate and against the inboard housing, engaging the dowel pins and all the sync cranks.

#### CAUTION



*Orient all sync cranks and the orbiting plate in the downward position.*

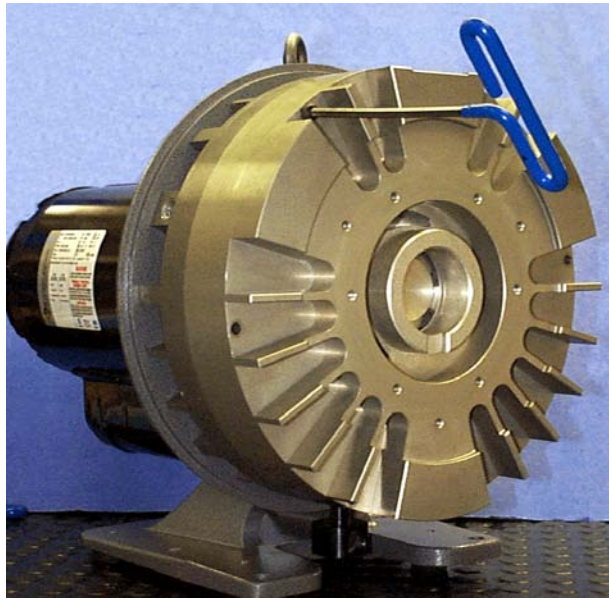

2. Secure the outboard housing to the inboard housing with the six M6x55 screws.
3. Tighten the screws sequentially in a diagonal pattern to 130 in-lb.

## Final Assembly (continued)

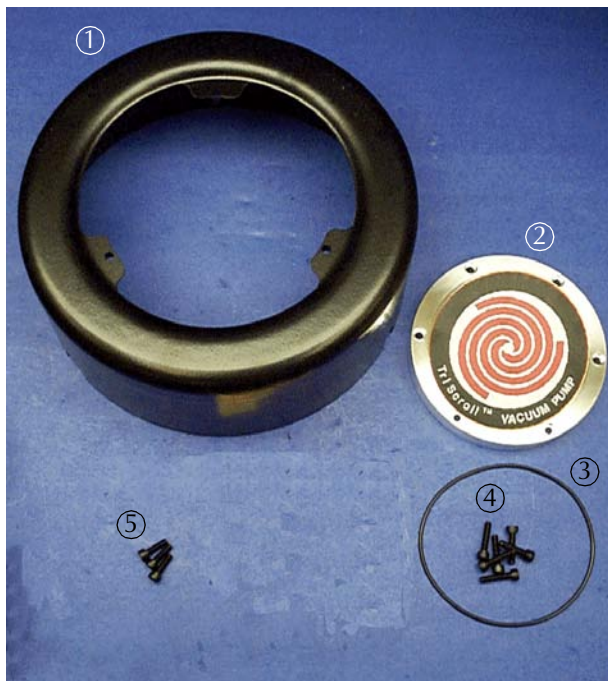

### Replace the Cowling, Cover, and Intake Fitting

Tools required:

- ❑ Allen wrench
- ❑ Krytox GPL 224 grease

Locate the following parts:

- ① Cowling
- ② Outboard cover
- ③ O-ring, 2-157, included in maintenance kit
- ④ M5x22 screws (6)
- ⑤ M5x16 screws (3)

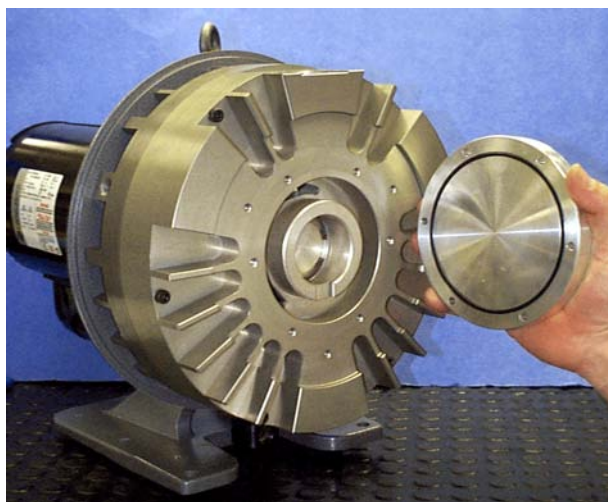

1. Lightly grease the O-ring and insert it into the groove on the outboard cover.

### Final Assembly (continued)



2. Secure the outboard cover to the outboard housing with the six M5x22 screws.

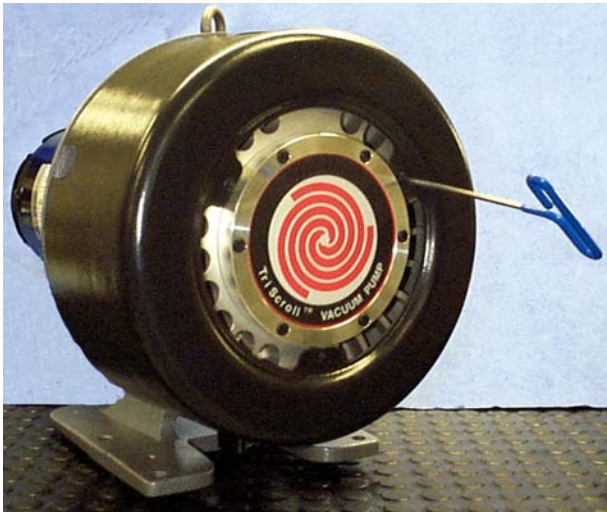

3. Install the cowling over the pump module.
4. Secure it with the three M5x16 screws.

## Final Assembly (continued)



Tools required:

- ❑ Snap ring pliers
- ❑ Allen wrench
- ❑ Krytox GPL 224 grease

Locate the following items shown in the photo to the left:

- ① Intake fitting
- ② M5x16 screws (2)
- ③ O-ring, 2-121, included in maintenance kit
- ④ Intake clamp

Intake screen (not shown)

Snap ring (not shown)

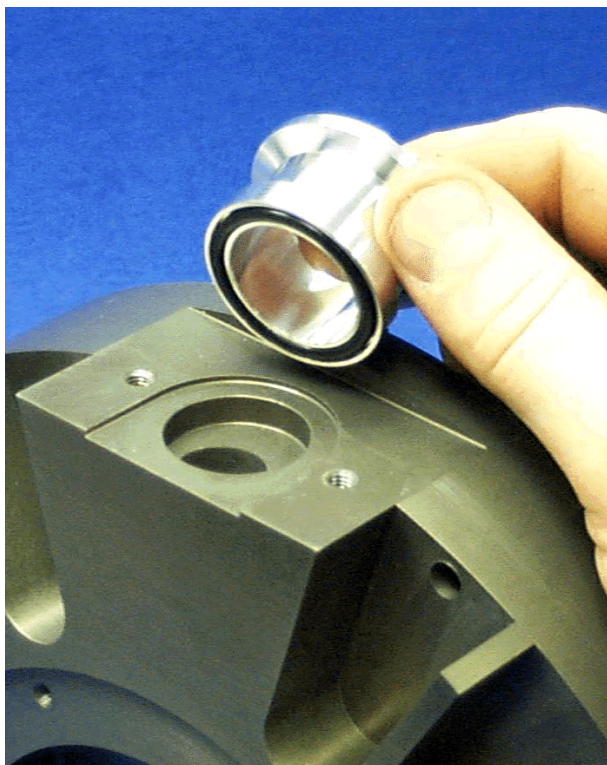

1. Lightly grease the O-ring and insert it in the groove on the underside of the intake fitting.

### Final Assembly (continued)

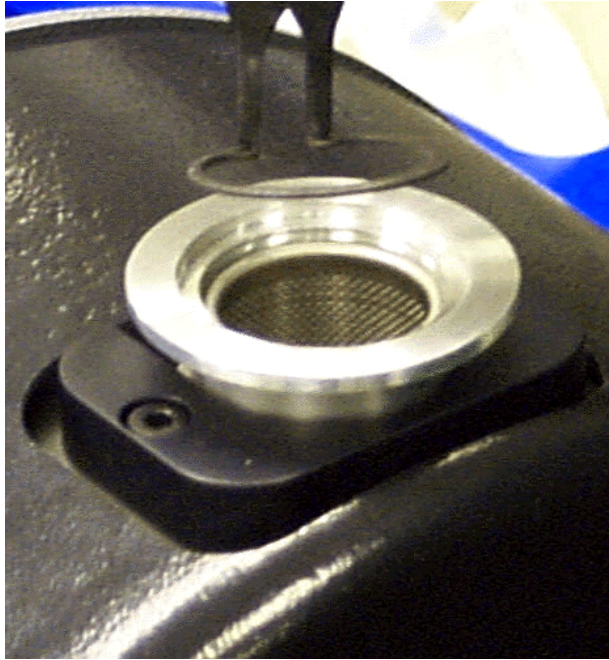

2. Slide the intake clamp around the intake fitting.
3. Place the intake fitting over the intake hole in the outboard housing.
4. Secure it with two M5x16 screws.
5. Tighten to 75 in-lb.
6. Install the screen into the intake fitting.
7. Secure it with the snap ring.



This figure illustrates a fully reassembled TriScroll 600 pump.

### Put the Pump Back into Service

The TriScroll 600 pump can be placed into service immediately after maintenance is complete. However, 24 hours of run time is required before base pressure of 7 mTorr can be achieved.

#### NOTE



*The 24 hour run time does not have to be continuous. If your application requires a low base pressure, it is wise to run the pump for the 24-hour period for optimum performance.*



## Vacuum Products Division

### Instructions for returning products

Dear Customer:

Please follow these instructions whenever one of our products needs to be returned.

1) Complete the attached Request for Return form and send it to Agilent Technologies (see below), taking particular care to identify all products that have pumped or been exposed to any toxic or hazardous materials.

2) After evaluating the information, Agilent Technologies will provide you with a Return Authorization (RA) number via email or fax, as requested.

**Note:** Depending on the type of return, a Purchase Order may be required at the time the Request for Return is submitted. We will quote any necessary services (evaluation, repair, special cleaning, eg).

3) **Important steps for the shipment of returning product:**

- Remove all accessories from the core product (e.g. inlet screens, vent valves).
- Prior to shipment, drain any oils or other liquids, purge or flush all gasses, and wipe off any excess residue.
- If ordering an Advance Exchange product, **please use the packaging from the Advance Exchange to return the defective product.**
- Seal the product in a plastic bag, and package product carefully to avoid damage in transit. You are responsible for loss or damage in transit.
- Agilent Technologies is not responsible for returning customer provided packaging or containers.
- **Clearly label package with RA number.** Using the shipping label provided will ensure the proper address and RA number are on the package. Packages shipped to Agilent without a RA clearly written on the outside cannot be accepted and will be returned.

4) Return only products for which the RA was issued.

5) **Product being returned under a RA must be received within 15 business days.**

6) **Ship to the location specified on the printable label, which will be sent, along with the RA number, as soon as we have received all of the required information.** Customer is responsible for freight charges on returning product.

7) Return shipments must comply with all applicable **Shipping Regulations** (IATA, DOT, etc.) and carrier requirements.



## Vacuum Products Division Request for Return Form (Health and Safety Certification)

Please read important policy information on Page 3 that applies to all returns.

### 1) CUSTOMER INFORMATION

<b>Company Name:</b>		<b>Contact Name:</b>	
<b>Tel:</b>	<b>Email:</b>	<b>Fax:</b>	
<b>Customer Ship To:</b>		<b>Customer Bill To:</b>	
Europe only: <b>VAT reg. Number:</b>		USA/Canada only: <input type="checkbox"/> <b>Taxable</b> <input type="checkbox"/> <b>Non-taxable</b>	

### 2) PRODUCT IDENTIFICATION

Product Description	Agilent P/N	Agilent S/N	Original Purchasing Reference

### 3) TYPE OF RETURN (Choose one from each row and supply Purchase Order if requesting a billable service)

- 3A.  Non-Billable     Billable    **➔ New PO # (hard copy must be submitted with this form):**
- 3B.  Exchange     Repair     Upgrade     Consignment/Demo     Calibration     Evaluation     Return for Credit

### 4) HEALTH and SAFETY CERTIFICATION

**AGILENT TECHNOLOGIES CANNOT ACCEPT ANY PRODUCTS CONTAMINATED WITH BIOLOGICAL OR EXPLOSIVE HAZARDS, RADIOACTIVE MATERIAL, OR MERCURY AT ITS FACILITY.**  
**Call Agilent Technologies to discuss alternatives if this requirement presents a problem.**

**The equipment listed above (check one):**

**HAS NOT** pumped or been exposed to any toxic or hazardous materials. OR

**HAS** pumped or been exposed to the following toxic or hazardous materials. If this box is checked, the following information must also be filled out. Check boxes for all materials to which product(s) pumped or was exposed:

Toxic     Corrosive     Reactive     Flammable     Explosive     Biological     Radioactive

**List all toxic/hazardous materials. Include product name, chemical name, and chemical symbol or formula:**

---

**NOTE:** If a product is received at Agilent which is contaminated with a toxic or hazardous material that was not disclosed, **the customer will be held responsible** for all costs incurred to ensure the safe handling of the product, and **is liable** for any harm or injury to Agilent employees as well as to any third party occurring as a result of exposure to toxic or hazardous materials present in the product.

**Print Name:** \_\_\_\_\_ **Authorized Signature:** ..... **Date:** \_\_\_\_\_

### 5) FAILURE INFORMATION:

Failure Mode (REQUIRED FIELD. See next page for suggestions of failure terms):

---

Detailed Description of Malfunction: (Please provide the error message)

---

Application (system and model):

**I understand and agree to the terms of Section 6, Page 3/3.**

**Print Name:** \_\_\_\_\_ **Authorized Signature:** ..... **Date:** \_\_\_\_\_



## Vacuum Products Division Request for Return Form (Health and Safety Certification)

Please use these Failure Mode to describe the concern about the product on Page 2.

### TURBO PUMPS and TURBO CONTROLLERS

APPARENT DEFECT/MALFUNCTION	POSITION	PARAMETERS
- Does not start - Does not spin freely - Does not reach full speed - Mechanical Contact - Cooling defective	- Noise - Vibrations - Leak - Overtemperature - Clogging	- Vertical - Horizontal - Upside-down - Other: .....
		Power:                      Rotational Speed: Current:                    Inlet Pressure: Temp 1:                    Foreline Pressure: Temp 2:                    Purge flow: OPERATING TIME:

### ION PUMPS/CONTROLLERS

- Bad feedthrough	- Poor vacuum
- Vacuum leak	- High voltage problem
- Error code on display	- Other

### VALVES/COMPONENTS

- Main seal leak	- Bellows leak
- Solenoid failure	- Damaged flange
- Damaged sealing area	- Other

### LEAK DETECTORS

- Cannot calibrate	- No zero/high background
- Vacuum system unstable	- Cannot reach test mode
- Failed to start	- Other

### INSTRUMENTS

- Gauge tube not working	- Display problem
- Communication failure	- Degas not working
- Error code on display	- Other

### SCROLL AND ROTARY VANE PUMPS

- Pump doesn't start	- Noisy pump (describe)
- Doesn't reach vacuum	- Over temperature
- Pump seized	- Other

### DIFFUSION PUMPS

- Heater failure	- Electrical problem
- Doesn't reach vacuum	- Cooling coil damage
- Vacuum leak	- Other

### Section 6) ADDITIONAL TERMS

**Please read the terms and conditions below as they apply to all returns and are in addition to the Agilent Technologies Vacuum Product Division – Products and Services Terms of Sale.**

- Customer is responsible for the freight charges for the returning product. Return shipments must comply with all applicable **Shipping Regulations** (IATA, DOT, etc.) and carrier requirements.
- Customers receiving an Advance Exchange product agree to return the defective, rebuildable part to Agilent Technologies **within 15 business days**. Failure to do so, or returning a non-rebuildable part (crashed), will result in an invoice for the non-returned/non-rebuildable part.
- Returns for credit toward the purchase of new or refurbished Products are subject to prior Agilent approval and may incur a restocking fee. Please reference the original purchase order number.
- Units returned for evaluation will be evaluated, and a quote for repair will be issued. If you choose to have the unit repaired, the cost of the evaluation will be deducted from the final repair pricing. A Purchase Order for the final repair price should be issued within 3 weeks of quotation date. Units without a Purchase Order for repair will be returned to the customer, and the evaluation fee will be invoiced.
- A Special Cleaning fee will apply to all exposed products per Section 4 of this document.
- If requesting a calibration service, units must be functionally capable of being calibrated.

## TriScroll 600 Dry Scroll Vacuum Pump

---

*This page intentionally left blank.*