



INSTRUCTION MANUAL

MULTI-STAGE DRY VACUUM PUMP

MODEL EV-A10

PURGE TYPE

CE / NRTL MODEL

200-240V (1Phase 50/60Hz)

200-240V (3Phase 50/60Hz)



CAUTION

*READ AND UNDERSTAND THIS INSTRUCTION MANUAL THOROUGHLY
BEFORE USING THIS EQUIPMENT.*

*BE SURE TO KEEP THIS INSTRUCTION MANUAL ON HAND FOR FUTURE
REFERENCE.*

To Facility and Tool Manufactures:

Be sure to distribute this INSTRUCTION MANUAL to all end-user personal actually operation this equipment.

The Products described herein fall under “the goods listed in row 16 of the appended table 1 of the Export Trade Control Order of Japan”, so in cases of export of such products, you need to confirm “use” and “purchaser and/or end-user” and, as case may be, obtain the approval of the Minister of Economy, Trade and Industry. (Please confirm these conditions on your own.)

For more information, please contact our sales office located near you.

Do not reproduce or reprint any portion of this manual without permission.

Manufacture reserves the right to discontinue or change any specifications or designs without notice and without incurring obligations.

MODEL EV-A10 in this instruction manual is our model code.

Environmental Basic Policies

It is our responsibility, as people of the earth, to protect nature's irreplaceable treasures and to pass them on to future generations.

As we undertake our business activities, we will establish environmental management systems and implement ongoing improvements and reviews, while striving to promote harmony between technology and nature, prevent environmental pollution, and improve the overall results of our environmental management activities. We are aware that environmental protection and management activities are the responsibility of all managers and employees of the Corporation, and each person will demonstrate this awareness when carrying out his or her duties.

We will widely publicize these basic policies to regional societies and the general public and work to make Ebara's position on the environment clear to society in general.

Foreword

Design of EBARA MODEL EV-A10 DRY VACUUM PUMP is based on superior engineering and long experience. To prevent any possible trouble and provide satisfactory operation and long life, it is important to thoroughly understand this EBARA MODEL EV-A10 DRY VACUUM PUMP by careful study of this manual. If any questions arise regarding this manual, please direct them to EBARA or your dealer. Your questions will be promptly answered and your suggestion may be considered for incorporation into our future product.



WARNING

BEFORE USING THIS EQUIPMENT, READ THIS INSTRUCTION MANUAL THOROUGHLY. MANUFACTURES WARRANTY WILL BE VOID, IF THE MODEL EV-A10 DRY VACUUM PUMP HAS BEEN INCORRECTLY INSTALLED, OPERATED OR MAINTAINED OR IF IT HAS BEEN MODIFIED OR REPAIRED WITH PARTS NOT SPECIFIED BY MANUFACTURE.

SINCE THE OPERATIONS OR WORKS THAT ARE NOT DESCRIBED IN THIS MANUAL COULD RESULT IN SERIOUS OR POSSIBLY EVEN FATAL INJURY OR DAMAGE TO THE PUMP, DO NOT THESE THAT ABSOLUTELY.

EBARA IS NOT LIABLE FOR ANY INJURY OR DAMAGE ARISING FROM AN INDIVIDUAL'S CARELESSNESS, OR MISUSE.

(1) Limited Warranty

The liability of EBARA CORPORATION under this Warranty covers the following.

Unless otherwise specified in the contact, the warranty period shall be either one year from the first date of operation or 18 months after the shipment from EBARA, whichever comes first.

1. When the purchased pump cause failure that owe to its design, manufacturing processes or other faultiness that EBARA is responsible to, EBARA will either repair the troubling parts or replace the pump at free pf charge. No extension of warranty is available even when the pump was replaced during the original warranty program.
2. Fees will be charged for repair in the following circumstances and for consumable parts:
 - 1) If the trouble occurs after Warranty has expired.
 - 2) If the trouble is caused by operating in the manner not described in the instruction manuals or using under special condition.
 - 3) If the trouble is caused by repair or remodeling of the pump by other than EBARA or authorization suppliers be EBARA.
 - 4) If the trouble is caused be corrosion or by-products due to pumping the corrosive or reactive substance.
 - 5) If the trouble is caused by fire, flood, earthquake, or other circumstances beyond EBARA's control.
3. EBARA will not be liable for any compensation for damage or injury resulting from breakdown of the pump.

(2) Repair and Servicing

Requests for repair or servicing of the pump shall be made to your dealer or to EBARA.

If any abnormal symptoms other than those displayed on the operational panel appear, take action in accordance with the instruction of Section 9 "Troubleshooting".

If trouble occurs, to order repairs or servicing. Please contact EBARA CORPORATION or an authorized Agent/Distributor, and provide the information on the nameplate and details of the problem.

If you have any inquiries about the pump, please contact EBARA.

(3) Safety Notice

It is essential that those operating this pump should have the knowledge to identify and avoid hazardous conditions associated with the pump. Inadequate or rush operation may cause dangerous and serious accidents. Before installation and operation, the operator should first have a good knowledge of the pump construction, operation procedure, and its hazards (e.g., electrical, stored electrical, thermal). The operator should read through this instruction manual and other documents issued by EBARA in detail.

The following symbols are used to highlight important information and instructions that must be followed to prevent personal injury or damage to equipment. Please study the symbols carefully so that the meaning of any warning you encounter is immediately clear.



 **DANGER** : indicates an imminently hazardous situation which, if not avoided, will result in death or serious injury.

 **WARNING** : indicates a potentially hazardous situation which, if not avoided, could result in death or serious situation.

 **CAUTION** : indicates a potentially hazardous situation which, if not avoided, may result in minor or moderate injury or possible damage to the equipment or machine.

NOTE : is used to call attention or to emphasize essential information.

The following symbols may appear on the model EV-A10 dry vacuum pump.

  : DANGER - Heavy Object

 : WARNING - Hot Surfaces

 : WARNING - Hazardous Voltage

Precautions necessary for safe use of the EBARA MODEL EV-A10 DRY VACUUM PUMP are detailed in this instruction manual, while important items concerning precautions for handling EBARA MODEL EV-A10 DRY VACUUM PUMP are listed below.

 **DANGER**

- Keep out from under the pump when lifted. Only qualified personnel shall unload and lift the pump.
- Keep the pump at horizontal when lifted.
- Do not lift the pump without eyebolt spacer.

 **WARNING**

- Be careful not to overturn the pump when pushing and pulling it sideways, because the width of the pump is small to its height.
- Be sure to turn off the power at the circuit protector (CP) and disconnect the power cable from the power connector, when the pump installing, the wiring and maintenance work. Never supply power to the pump, Until you have completed these works.
- Electrical wiring shall be carried out only by qualified electricians.
- Be sure to connect the grounding wire, otherwise an electric shock may be caused by electric leakage.
- The earthing of the pump is realized by connecting the cable with qualified electricians. The qualified electricians should have themselves a connection the ground.
- The pump unit is not equipped with circuit breaker (CB). Please install CB based on the law and the standard in the installation region.
- The pump must be connected to electrical power supply with a suitable circuit breaker (lockout/tagout CB).
- Be sure to check for leaks after you have installed the pump. When checking for gas leaks by pressurization, please pressurize by less than 0.05 MPa into the exhaust piping.
- This pump is suitable for use on clean and non-corrosive gases. Do not use explosive, flammable, toxic or corrosive substances.
- The pump and exhaust piping will remain at a high temperature during operation and for a short time after the pump has stopped. Be sure to avoid contact and keep inflammable substances out of reach. Do not remove the pump cover during operation.
- Do not perform a withstand voltage test. Failure to comply could result in damage to the sensitive devices.
- Do not insert any part of body to ventilation inlet. Moving parts of the cooling fan can crash and cut.
- Check safety interlock functions periodically (every 6 months) to confirm the interlocks will work correctly.
- Do not alter the pump member nor change any parts without the EBARA's consent or approval.

 **CAUTION**

- Do not step on the pump or place object on it.
- The exhaust piping made by polyvinyl chloride causes the noise through the pipe.
- Do not apply the power supply from the pump's power pack to any other equipment as this will result in malfunctioning of the control units and in pump failure.
- Use the correct wiring materials and size to match the operating conditions in accordance with the power consumption rating and ambient air temperature of the pump.
- Vents at both ends, both side, and top of the pump. Place the pump enough space from the stationary section. If the cooling air supply is insufficient, the pump temperature will rise and problems such as rotor contact will occur.
 - Front / Rear / Top : 100mm or more
 - Both side : 50mm or more
- Install pump in a location at an ambient not exceeding 40 deg C. Particular caution is required when the pump is operated in an enclosed room.
- Never operate the pump without pump cover for safety.

NOTE

- Pump must be placed in an upright position. Do not stack as packing. When the pump is overturned, this will result in accident.
- To fix the pump, the height-adjustment feet of four each are attaches. If the pump is not stable, vibration and noise of the pump may be increased.
- Do not wire vacant pins.
- Apply a 24V DC power for input signals on the pump side. Do not apply this voltage on the equipment side.
- Be sure to wire all signals with the correct polarity (+/-).
- When output signals are used to energize an inductive load such as a relay, be sure to insert a diode (100V. 1A class) in order to absorb the back electromotive force due to surge currents.
- The pump cannot start while the measuring instruments are booting after the CP is placed in the ON position.
- The pump will not start when an ALARM has been generated. After you have taken the remedial action, reset the pump.

(4) Safety Warning Labels

Following safety labels are attached to pump covers.

1. Hazardous weight danger
2. Hazardous voltage warning
3. High temperature warning
4. Electric charge mark

1. Hazardous weight danger

Heavy object may cause injury or death due to overturning or falling pump. Keep out from under the lifted pump. Raise all adjuster-feet fully when moving.

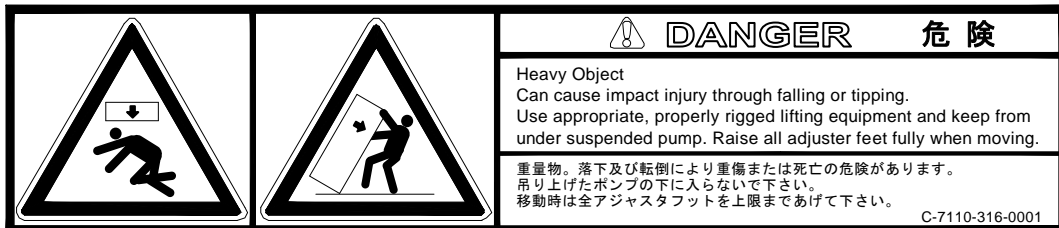

2. Hazardous voltage warning

Hazardous voltage may shock, burn, or cause death. Turn power off and lockout before servicing.

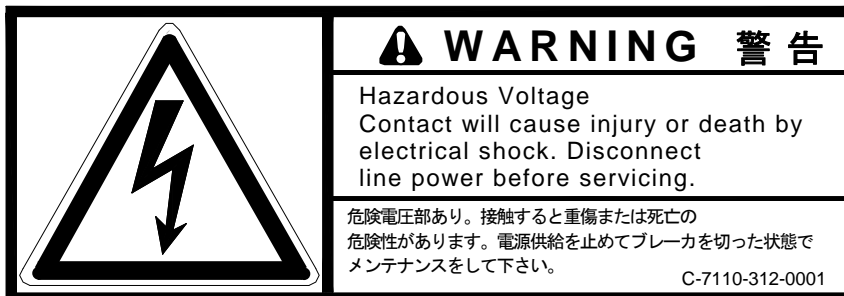

3. High temperature warning

Hot surface may burn or cause injury. Allow the piping and casing to cool before servicing.



4. Electric charge mark



Top View

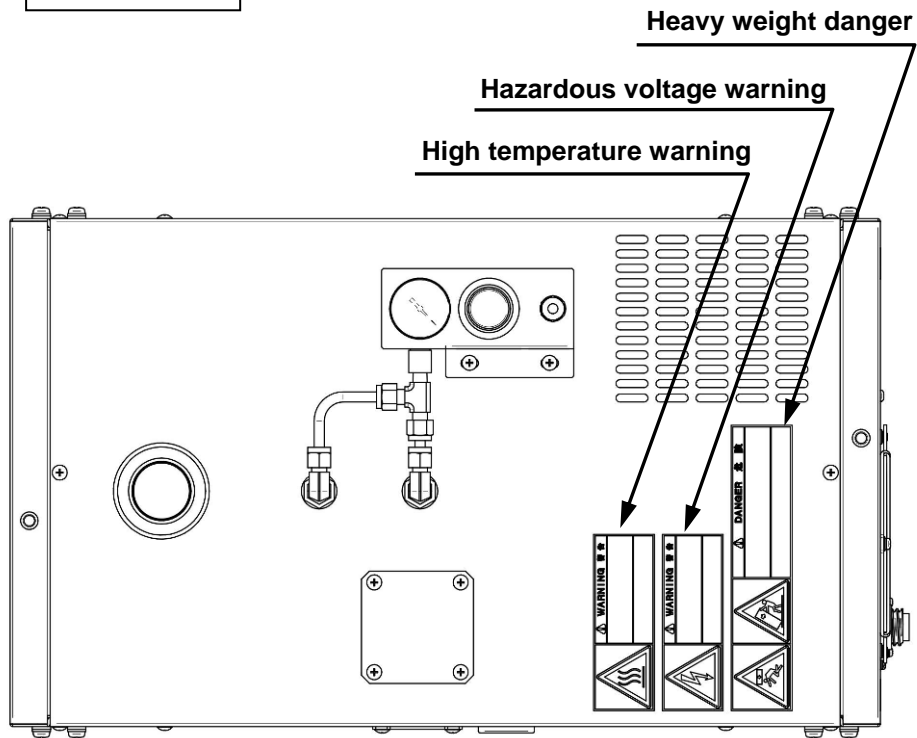

Front View

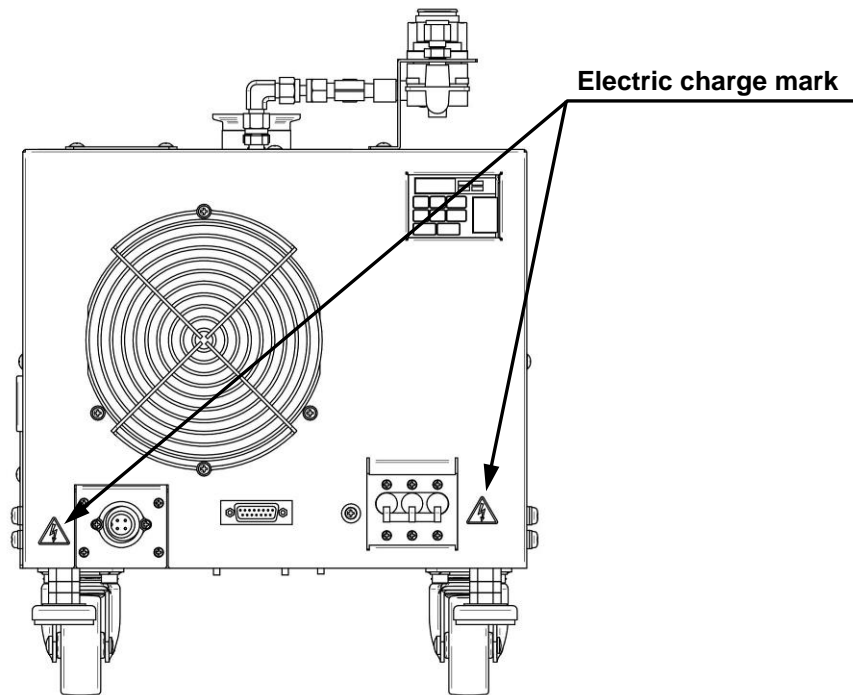

(5) Safety Interlocks**WARNING**

Check Safety Interlock functions periodically (every 6 months) to confirm the interlocks will work correctly.

Motor thermostat protect the pump motor from overheating due to extended current draws in excess of the motor rating. Under a persistent overload condition, motor thermostat opens a contact, which interrupts the motor run circuit. A brief cool down interval permits restarting the pump

3.2 Piping	32
3.2.1 Vacuum and Exhaust Piping	32
3.3 Electrical Wiring	33
3.3.1 Power Supply Wiring	33
3.3.2 Control Signal Wiring	37
4. Operation Panel	40
4.1 Operation Panel Outline	40
4.2 Operation Panel Display	43
5. Operation	45
5.1 Before Starting	45
5.2 START / STOP	46
5.3 Pump speed control mode	48
5.4 Operation when momentarily power failure happens	49
5.5 Nitrogen (N ₂) Gas Purge	50
6. Maintenance and Inspection	52
6.1 Routine Inspection	52
6.2 Vacuum and Exhaust Piping	52
6.3 Lubrication Oil	53
6.4 Maintenance Parts List	56
6.5 List of Wastes During Maintenance	56
6.6 Repair and Service	57
6.7 Overhaul	57
7. Storage / Disposal	57
7.1 Storage	57
7.2 Disposal	57
8. Disconnection and Transportation	58
9. Troubleshooting	60
9.1 Troubleshooting (1) : Basic trouble	61
9.2 Troubleshooting (2) : ALARM	61

[Attachment Data]

Appendix 1 : Material Safety Data Sheet of Lubricant oil (JPN)

Appendix 2 : Material Safety Data Sheet of Lubricant oil (ENG)

Appendix 3 : Overhaul / Repair Request form (JPN)

Appendix 4 : Overhaul / Repair Request form (ENG)

Appendix 5 : Leak Check procedure

Information of Global Network

1. Introduction

1.1 Acceptance Check

Check the following items on receipt of the pump package.

- 1) Check that the nameplate affixed to the outer cover of the pump to confirm that the pump supplied agrees with your order. Check the accessories against the packing list and the previously submitted drawings and documents to confirm that the all ordered accessories have arrived.
- 2) Check whether damage has occurred or screws/bolts have worked themselves loose in transit.



CAUTION

Notify EBARA immediately, when damage is discovered or when components are missing. Do not use when a leak is present as this will result in accident.

- 3) Store the pump in a dry and clean place until installation.

Temperature : 5 to 40 deg C

Humidity : 80% or less (condensation must not exist)

- 4) The pump must be placed in an upright position.

NOTE

Do not stack the pump. The pump must be placed in an upright position. When the pump is overturned, lubricating oil inside a pump may leak to a rotor room, and it may cause trouble to operation.

1.2 Environmental Concerns

Handling or operating the unit other than specified may induce adverse impacts on the environment. Follow the descriptions below to handle, operate, and maintain the unit.

- 1) Ask an authorized waste-disposal company to dispose packing materials from uncrating according to laws and ordinances applicable to the waste.
- 2) Maintenance failure of the pump (including overhaul) may trigger accidents causing injury or death, unit troubles, or environmental pollution. Plan the maintenance and perform it periodically to operate the unit efficiently.
- 3) To dispose the unit, follow effective laws and ordinances applicable in the area where the unit is installed.
If you have any inquiries about the pump, please contact EBARA.
- 4) To dispose the lubricant oil and chemicals, follow effective laws and ordinances applicable in the area where the unit is installed.

2. Product Description

2.1 Outline

This pump has a compact design and includes controls to enhance reliability and operation.

This pump is suitable for use on clean and non-corrosive gases. Do not use explosive, flammable, toxic or corrosive substances.

2.1.1 Pump Module

The pump is Roots type Dry vacuum pump, which rotates a pair of non-contact multi-stage rotors, synchronized by timing gears.

The timing gears and bearings are enclosed in a compartment that is independent of the casing. For lubrication Perfluoro-Polyether (PFPE) oil and grease are used. The pump is factory filled with lubrication oil.

Replenish or replace only with the recommended oil grades shown in Specification Table 2.1.

2.1.2 Cooling Fan

Because the pump compresses gas from a vacuum to atmospheric pressure, compression heat is generated. Therefore cool the pump with cooling fan.

Place the pump enough spaces from the stationary section.

FRONT / REAR / TOP	:	100 mm or more
Both side	:	50 mm or more

2.1.3 Exhaust

A check valve is provided as a standard accessory to prevent reverse flow of gas from the exhaust through the pump to the vacuum chamber when pump is stopped.

2.2 Control System

This pump has a built-in unit consisting of a Circuit Protector (CP), Noise Filter (NF), and Inverter. During pump operation, some conditions are monitored, including electrical power and current for motor. Continuous operation is possible when there is a momentarily power failure (170V or less) of 1sec or less.

2.2.1 Alarm Control System

To assure the reliability of the pump as a vacuum exhaust system, the pump protection system generates an ALARM signal. This signal output is generated and the pump will stop automatically when the upper mechanical safety limit is reached during pump operation.

Be sure to contact EBARA for details on checking the ALARM setting condition.

All ALARM signal are displayed on the front panel. For remote operation and monitoring, the signal is available as group output.

2.3 The Way of Pump Moving

⚠ CAUTION

- When using the tool to raise adjuster feet, be careful of handling of the tool.
- Do not heave the pump.

2.3.1 Preparation

Raise all four adjuster feet fully before moving the pump; otherwise, an obstacle on the floor may cause the moving to tip over.

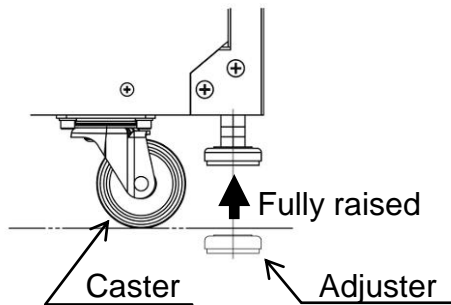

2.3.2 Moving Method

Move pump slowly by pushing at eye bolt along the long axis of the pump (direction A).

Keep toes and fingers away from moving wheels. If placing the pump in an corner or narrow space requires moving it along the short axis (Direction B), two persons should “walk” the pump over by alternately pushing the ends as shown below.

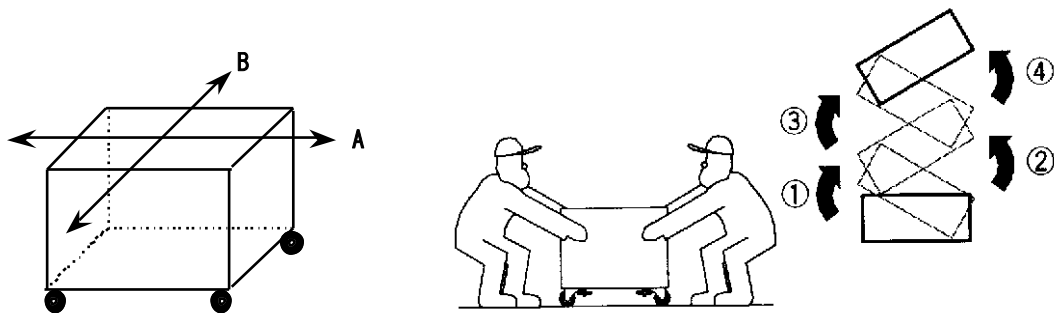

To move the pump across step, cracks or joints in the floor, spread a steel plate or similar device, which can sustain the pump weigh, over the discontinuity. At least two persons, using great caution, should move the pump.

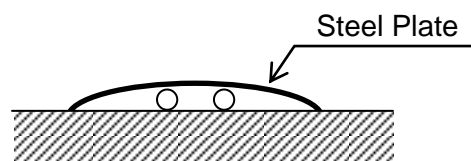

If a moving pump should lose balance and start to tip over, do not attempt to stop it. Get away from the pump immediately.

2.4 Release and shut off residual internal energy



WARNING

- To avoid dangers potentially encountered during maintenance, transportation or storage, follow instructions below to shut off power.
- Capacitors within the control panel retain residual energy after interruption of power supply. Wait five (5) minutes after shutting off breaker before opening the control panel. Carefully check that bleed circuits have discharged the residual energy before servicing the control panel.

2.4.1 Electrical Power – Lockout and Tagout

Lock the branch circuit in the OFF position and tag it out to perform maintenance or troubleshooting.

The Lockout / Tagout procedures must comply with OSHA 29 CFR 1910.147 and 1910.331-335.

- 1) Turn off the pump circuit protector.
- 2) Turn the branch circuit disconnect off. Check with a voltmeter that the power is shut off the pump.
- 3) Insert padlock through holes provided on locking device. Close padlock and attach tag. Keep the key with you while working.
- 4) Check that the display panel is off.

2.4.2 Returning to Service

- 1) Remove handle stop bracket and switch circuit breaker on.
- 2) Restart pump and open foreline valve only after appropriate leak checks and safety verifications are completed.

2.5 Detailed Specification

The following tables and figures should be consulted for pump specification, dimension and performance details.

2.5.1 Model Description

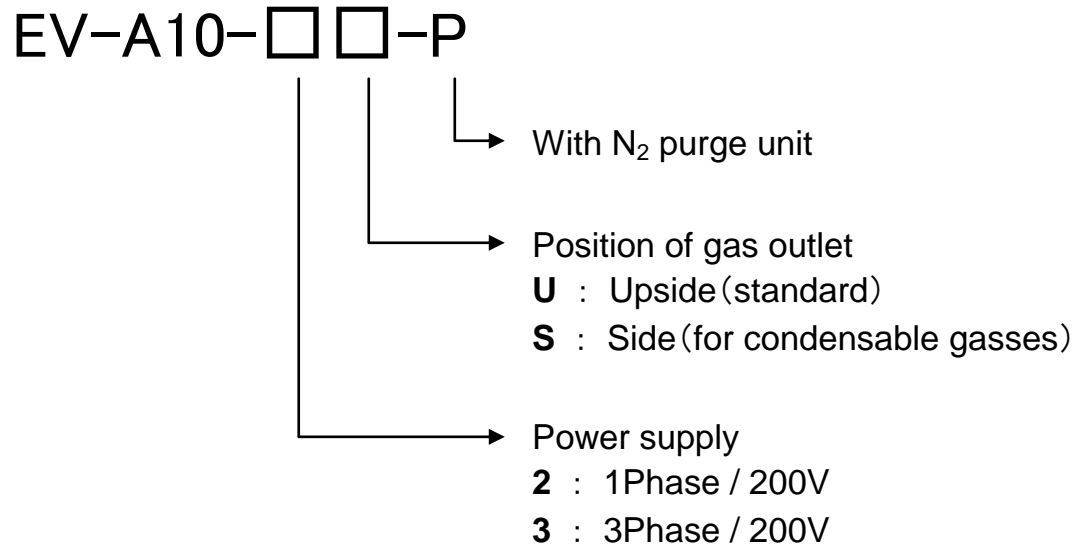

2.5.2 Specifications

Table 2.1 Specification

Model		MODEL EV-A10	
		EV-A10-2*-P (1Phase 200V)	EV-A10-3*-P (3Phase 200V)
Pumping Speed	Maximum	1,000 L/min	
	Atmospheric	800 L/min	
Ultimate Pressure		3.0 Pa	
Maximum Inlet Pressure		Atmospheric	
Maximum pure water vapor tolerance [note 1]		500 g/hr	
Connection	Gas Inlet	NW40	
	Gas Outlet	NW40	
Drain Port [note 2]		3/8" Tube Fitting	
N ₂ Purge	Connection	1/4" Tube Fitting	
	Pressure [Gauge Pressure]	Supply : 0.15 – 0.7 MPa [Setting : 0.1 MPa]	
	Approx. Flow Rate	17.5 Pa·m ³ /sec	
Approx. Power	at Ultimate Pressure	1.1 kW	
	Maximum	1.3 kW	
Current Rating		11.1 A	6.5 A
Lubrication oil	Brand, Manufacturer	BARRIERTA J100ES, NOK	
	Quantity	90 mL	
Approx. Weight		75 kg	
Power Supply	Inlet Voltage [50/60 Hz]	1Phase, 200-240 V	3Phase, 200-240 V
	Tolerable Voltage Fluctuation [note 3]	+/- 10 %	
	Power Capacity	3.0 kVA	
	Connection	IEC 60320-C20	Amphenol C016 20C003 100 12
Circuit Protector Rating		16 A	15A
SCCR		1.0 kA	1.0 kA
Control Signal		D-sub 15Pin	
Cooling System		Air Cooling	
Ambient Temperature		5 to 40 deg C	

[note 1] It is an amount of the maximum processing when the gas ballast is "ON".

[note 2] There is no drain port for Model EV-A10-2/3U-P.

[note 3] This is tolerable voltage range, and is not steady voltage.

2.5.3 Outline Drawing

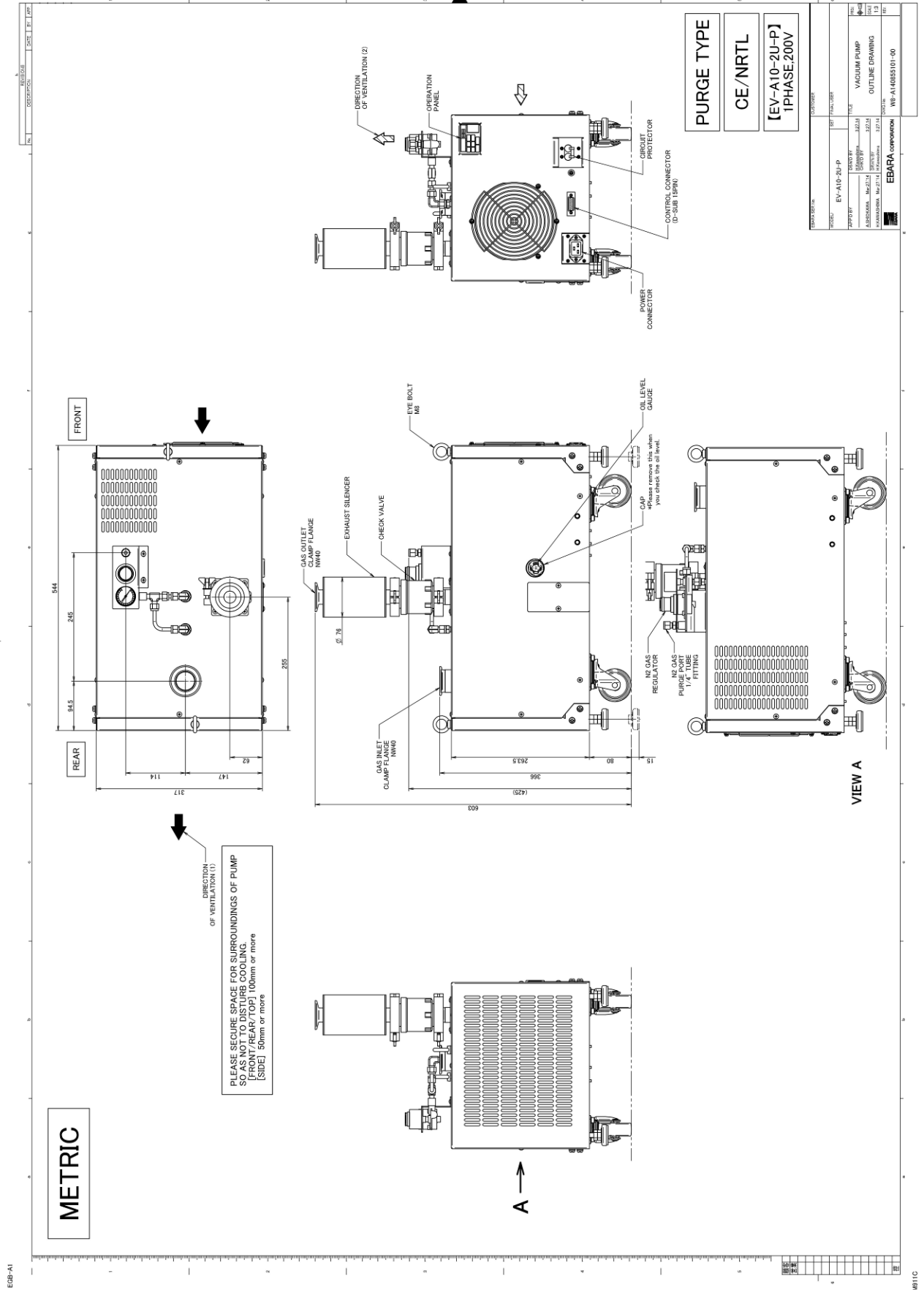

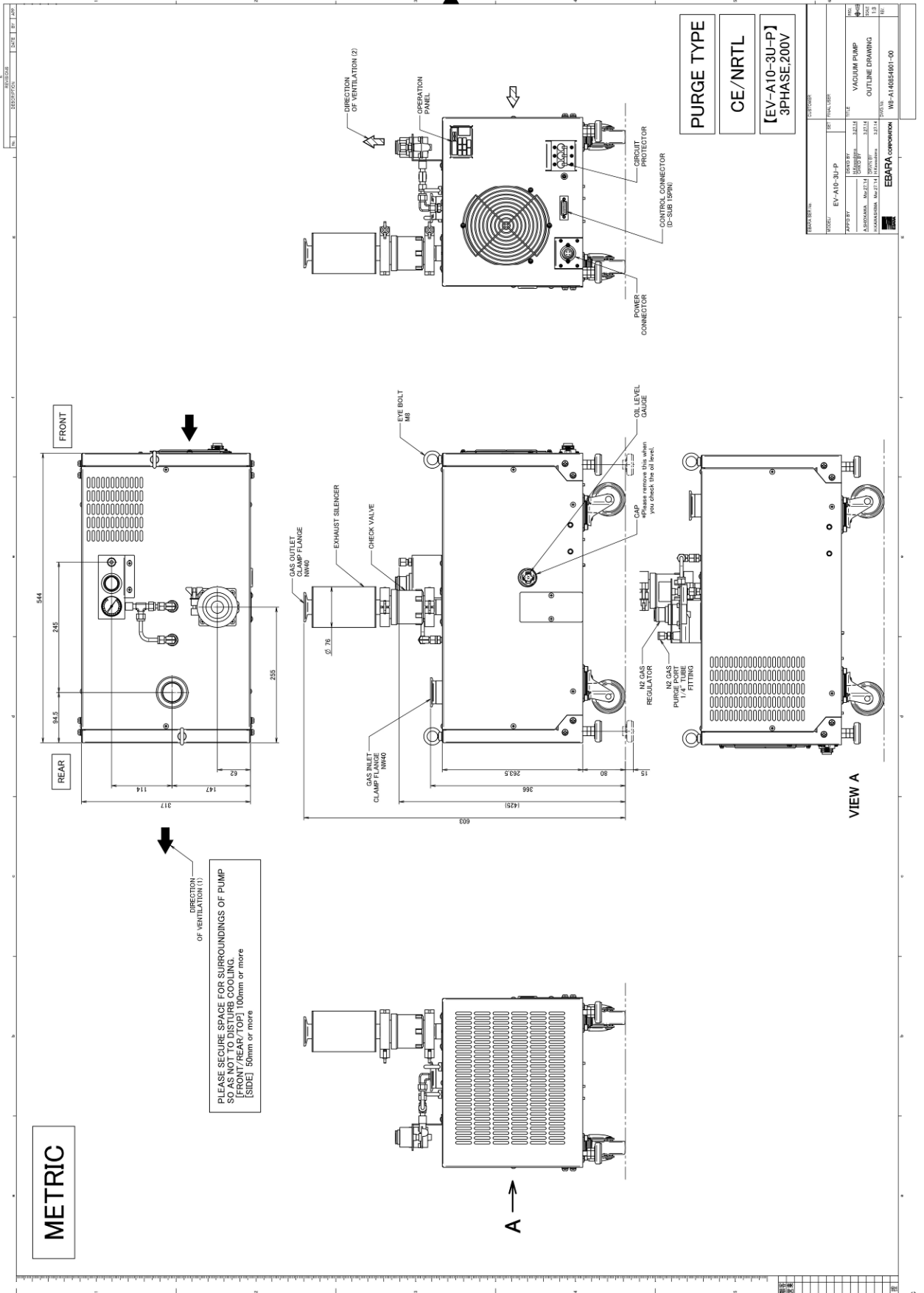

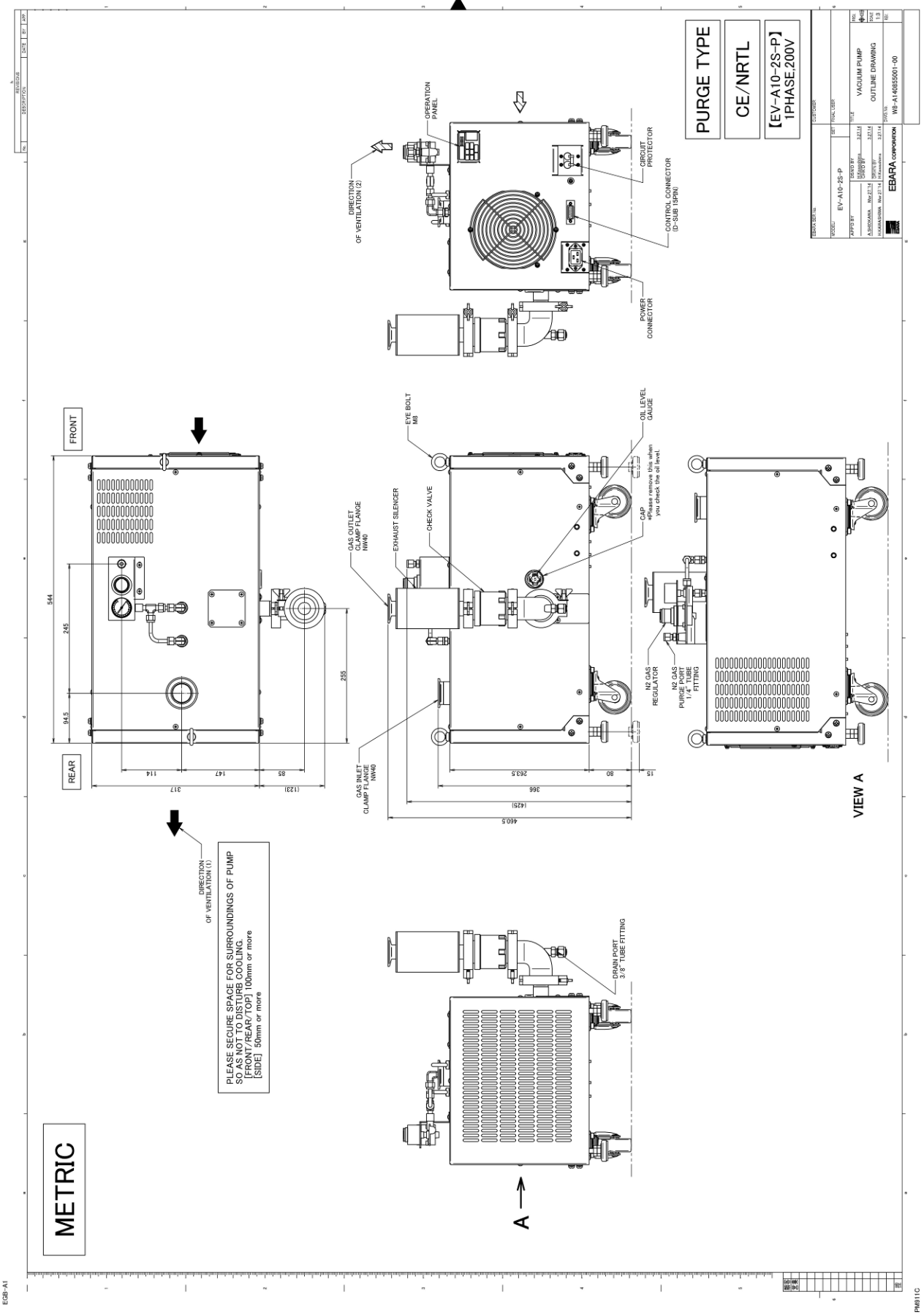

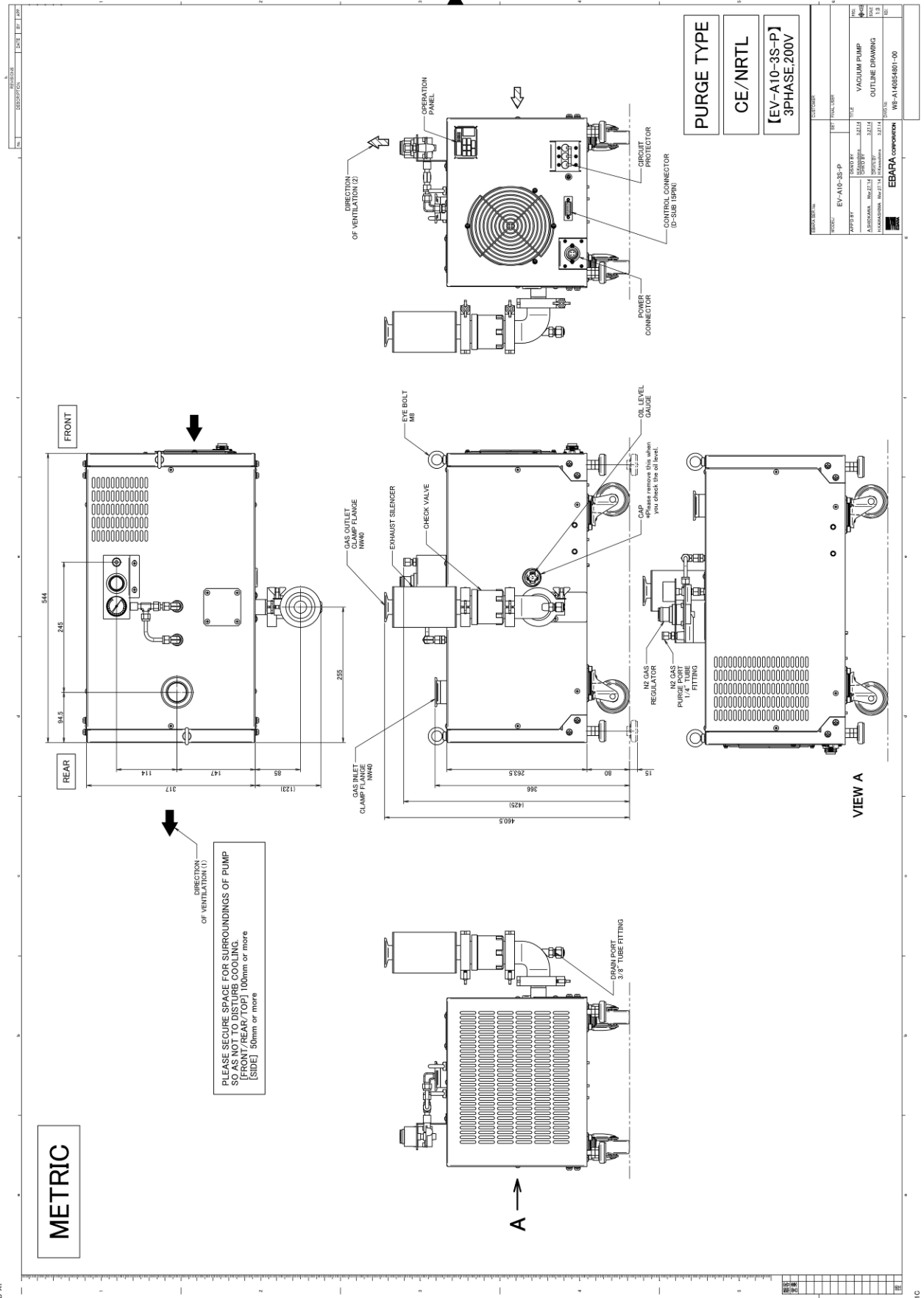

2.5.4 Performance Curve

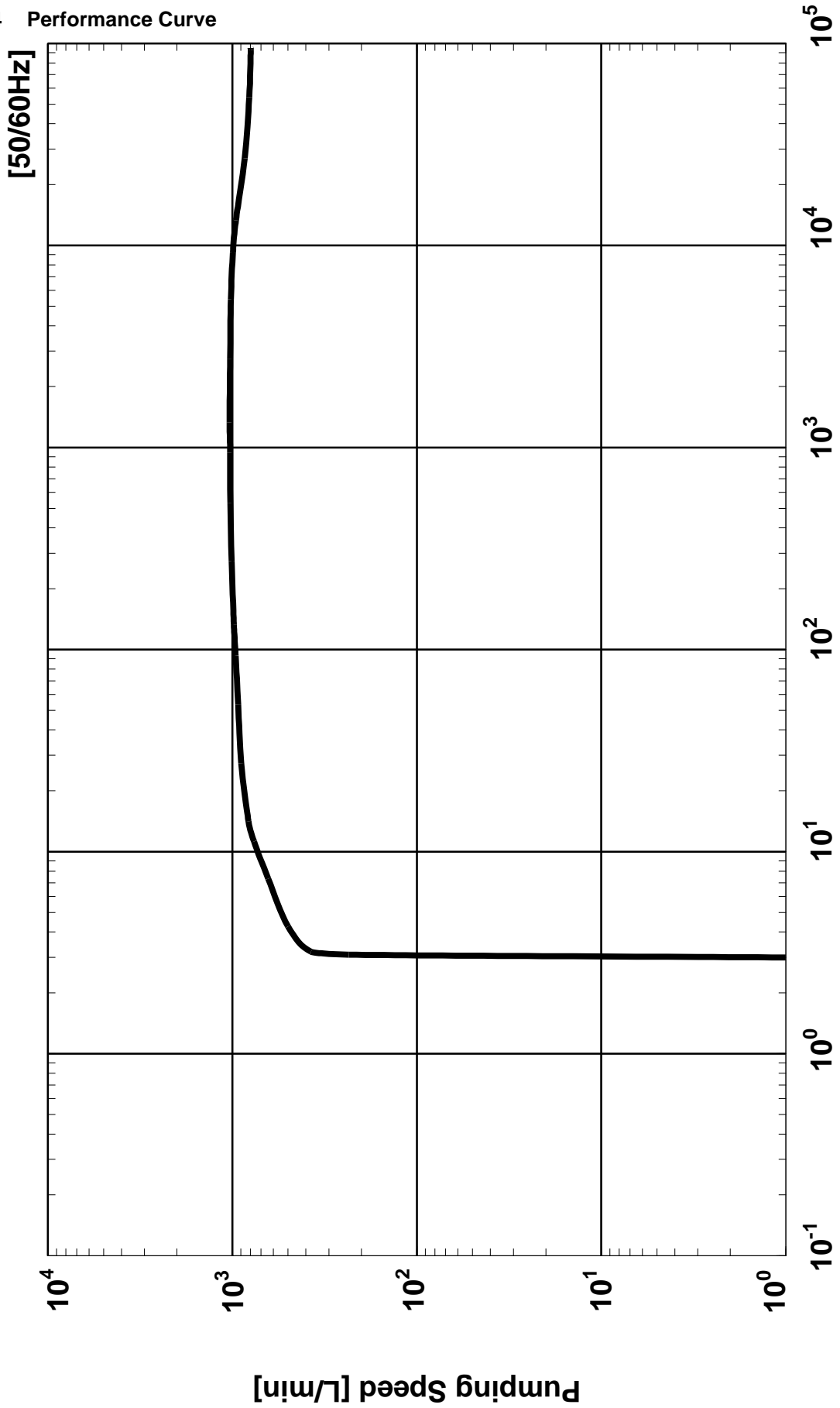
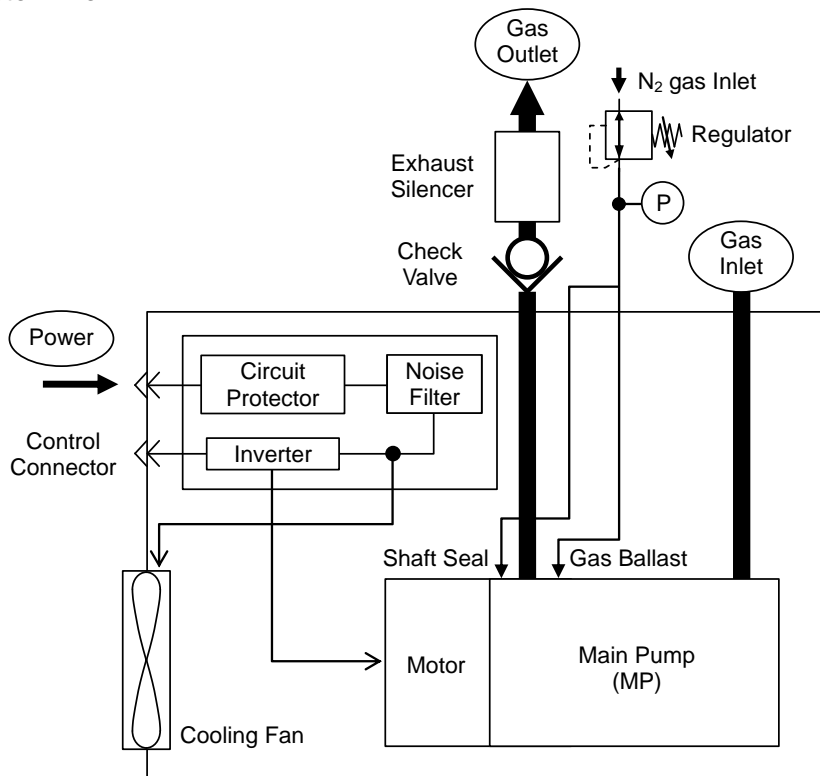
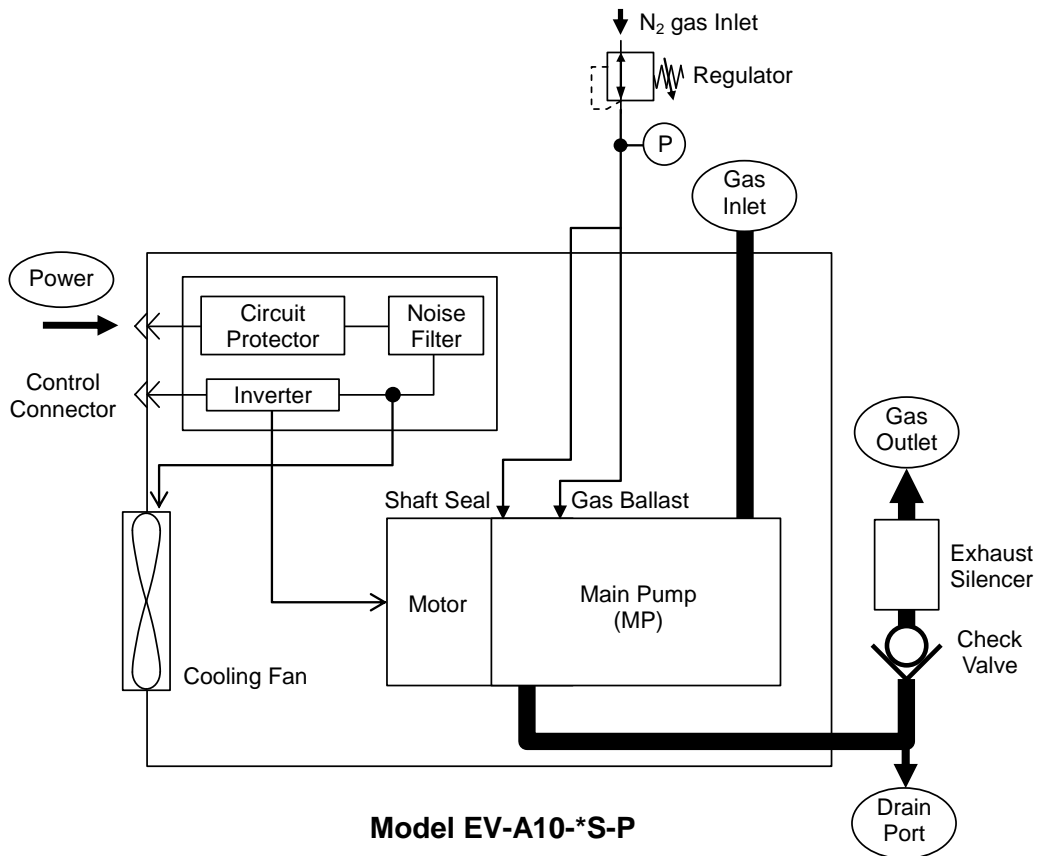

Fig. 2.1 Model EV-A10-2U/2S/3U/3S-P Performance curve

2.5.5 System Flow



Model EV-A10-*U-P



Model EV-A10-*S-P

Fig 2.2 System Flow

3. Installation

Observe the following cautions and instructions when installing the pump.

3.1 Movement and Fixation

3.1.1 Location

This pump is designed for indoor installation. To install the pump, select a place following environmental condition. Also allow for sufficient space to ensure easy pump installation and maintenance.

Area of use	: Indoor Use only
Ambient temperature	: 5 to 40 deg C
Humidity	: 80% or less (condensation must not exist)
Altitude restriction	: Max. 2000m
Pollution	: Pollution degree 2

Do not install the pump in the environment exposed rain, snow, ice or dust.

CAUTION

Do not install pump in a location where ambient temperature ever exceeds 40 degC. Use particular caution when installing the pump in an enclosed room.

CAUTION

Vents at both ends, both side, and top of the pump. Place the pump enough space from the stationary section. If the cooling air supply is insufficient, the pump temperature will rise and problems such as rotor contact will occur.

Front / Rear / Top	: 100mm or more
Both side	: 50mm or more

3.1.2 Caster and adjustment foot

Four integral mobile support units consisting of a caster and a height-adjustment foot each provided underneath the pump base. To move the pump, raise the four adjustment feet by turning the holding nuts in the counter-clockwise direction.

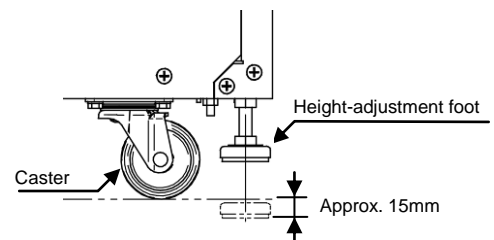

Fig 3.1 Caster and height-adjustment foot

WARNING

Be careful not to overturn the pump when pushing and pulling it sideways. The pump is narrow in comparison to its height.

 **CAUTION**

The neck portion of the casters will vibrate when the caster is moving.
Keep fingers and feet away.

 **CAUTION**

Do not step on the pump or place objects upon it..

- 1) Turn the holding nuts clockwise (looking down) to lower the height-adjustment feet and secure the pump.
- 2) Adjust the height of the feet evenly to ensure that the pump base is level.
- 3) The difference in height between the two sides of the pump base shall not exceed 1mm. The adjustment allowance is approximately 15 mm.

 **CAUTION**

When using the tool to adjust the height of the adjustment feet, be careful of handling of the tool.

 **CAUTION**

If the pump is not leveled, shortage of the lubrication oil supply to the bearing may be caused.

NOTE

Floor vibrations and airborne noise will increase unless the adjustment feet are used.

3.1.3 Pump Anchoring (Option)

Pump include casters for short distance moves and foot adjusters to set height and stop pump from rolling as described in Section 3.1.2. However, an earthquake may cause the pump to move or fall. To secure the pump, EBARA provides [optional] anchor brackets for Model EV-A10 dry pump to fasten the pump body to the floor. Anchor the pump to the floor or other firm surface with these brackets.

For bracket dimensions and locations, see the accompanying drawing.

Select anchor bolts that are appropriate for the weight of the pump and the anchoring surface; install them per the manufacturer's recommendations.

EGB-A2

METRIC

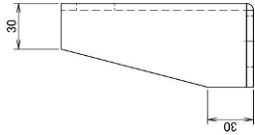
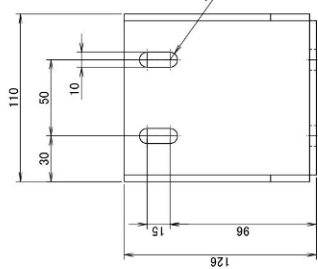
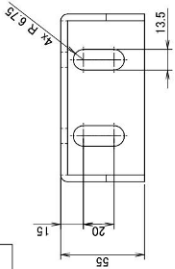

No.	①	②	③	④	TOTAL
LOADED WEIGHT ON EACH ADJUSTER FOOT [kg]	17	14	24	20	75

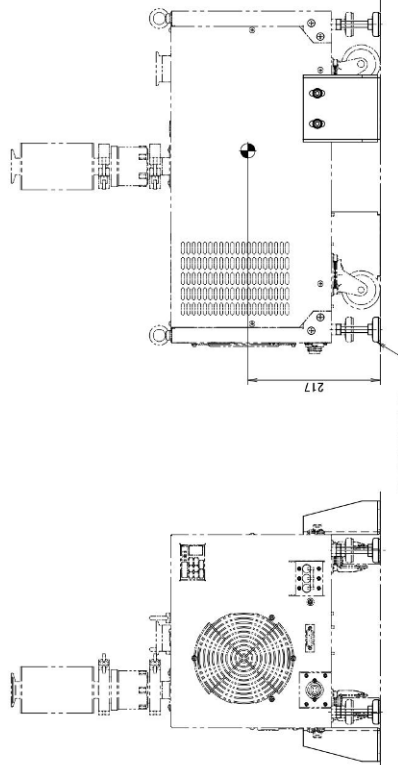
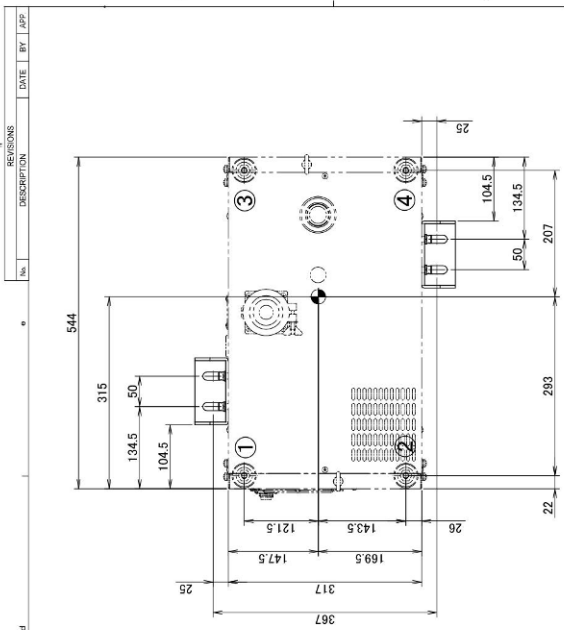

FIXTURE (MATERIAL : CARBON STEEL)

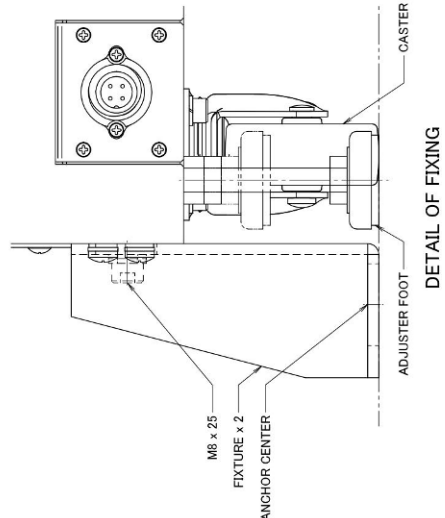

NOTES
 1) MARK INDICATES CENTER OF GRAVITY OF PUMP UNIT.
 2) M12-SIZED BOLTS SHALL BE USED FOR ANCHOR.

CE / NRTL

顧客名	
品名	
仕様	
数量	
単位	
備考	

MODEL	EV-A10-2U / -3U	SET	PANEL USER
APPROVED BY	DESIGNED BY	DATE	
A. SHIKAWA	C. OKADA	10.04.12	VACUUM PUMP
HAWASHIMA	HAWASHIMA	10.04.12	LOCATION FIXTURE
		10.04.12	REF. 1.5
			REF.
EBCA CORPORATION		WFS-A121878101-00	

EGB-A2

METRIC

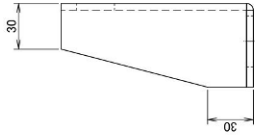
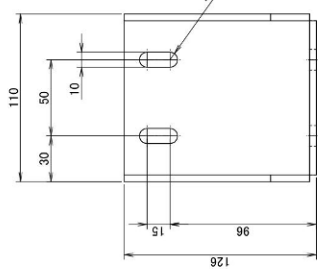
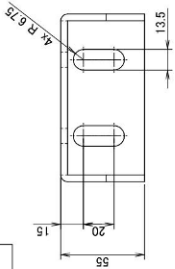

No.	①	②	③	④	TOTAL
LOADED WEIGHT ON EACH ADJUSTER FOOT [kg]	17	14	25	19	75

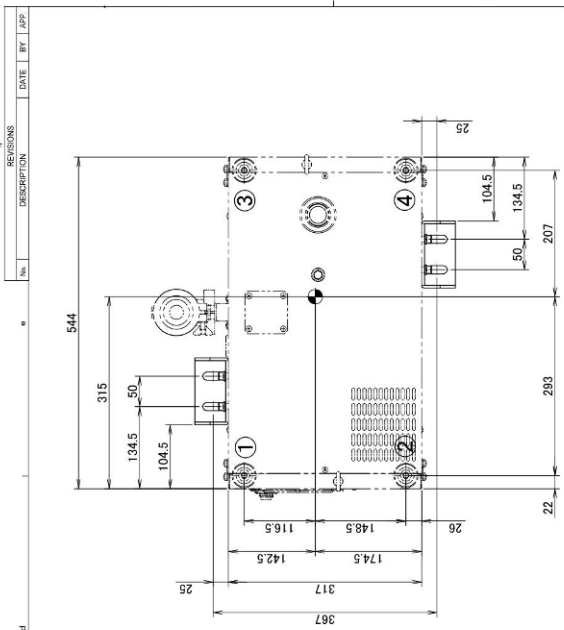

FIXTURE (MATERIAL : CARBON STEEL)

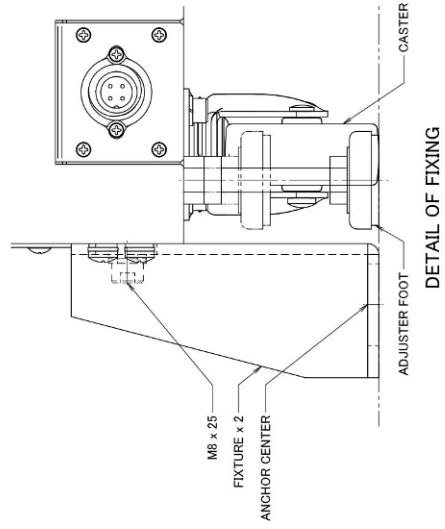

NOTES
 1) MARK INDICATES CENTER OF GRAVITY OF PUMP UNIT.
 2) M12-SIZED BOLTS SHALL BE USED FOR ANCHOR.

CE / NRTL

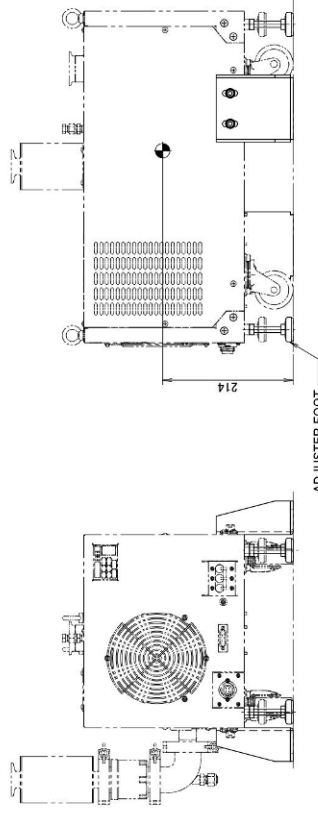

顧客 名称	
品番	

MODEL	EV-A10-2S / -3S	SET	PANEL USER
APPROVED BY	DESIGNED BY	DRAWN BY	DATE
A. SHIKAWA	C. SUGIURA	H. HAWASHIMA	10.04.12
HAWASHIMA CORPORATION	HAWASHIMA CORPORATION	HAWASHIMA CORPORATION	10.04.12
TITLE	VACUUM PUMP LOCATION FIXTURE		
DWG. NO.	WF-A121878201-00		
CUSTOMER			

3.2 Piping

3.2.1 Vacuum and Exhaust Piping

Connect the vacuum and exhaust pipes to the suction and exhaust flanges respectively.

Because of the narrow clearance between pump rotors, ingestion of foreign objects will prevent the pump from operating. Observe the following cautions when making the flange connections.

**CAUTION**

For the safety piping work, please keep sufficient space around the pump.

- (1) Remove all foreign matter from inside the piping.
- (2) When connecting flanges, ensure that no dirt or dust particles adhere to the flange surfaces and that the flange surfaces are damaged. Provide a suitable means of preventing the ingress of reaction by-products adhering to the pipes and foreign objects. For this purpose, a filter may be installed.
- (3) The weight of the pipes attached to the pump can cause misalignment and leaks from the flange connections. Support the piping properly and do not apply excessive force to align flange faces. EBARA recommends the insertion of a flexible bellows between the piping and the suction and exhaust flanges of the pump. Length of the flexible bellows on the suction side will vary according to the vacuum drawn. Connect without applying undue force to the flexible bellows.
- (4) Please decide a part to connect to the pump exhaust so that the exhaust pressure is not beyond atmospheric pressure.

**WARNING**

Check for leaks after installing the pump.

When conducting gas leak check by pressurization, do not exceed 0.05MPa as supply pressure.

**WARNING**

The pump casing, inlet piping and exhaust piping become extremely hot during operation and for some time after stopping. Be sure that pump and exhaust piping do not come in contact with humans or inflammable substances. Do not remove the pump cover during operation.

**CAUTION**

Do not connect the chamber which is not fixed to the pump.

**CAUTION**

The exhaust piping made by polyvinyl chloride causes the noise through the pipe.

**CAUTION**

When connecting the pipes, be careful not to pinch a hand.

3.3 Electrical Wiring

 **WARNING**

Keep the power supply to the pump turned off and locked out and the pump Circuit Protector(CP) interrupted until completing the wiring and connection work. Also remove the power connector and inlet the Circuit Protector (CP) during this.

 **WARNING**

Only a qualified electrician, using appropriate materials and workmanship, should perform the electrical wiring.

 **WARNING**

CB is not installed in the pump unit. Please install CB based on the law and the standard in the installation region.

 **WARNING**

Do not perform a withstand voltage test. Failure to comply could result in damage to the sensitive devices.

 **CAUTION**

Applying power from the auxiliary power connector to any other equipment may cause a malfunction of the control units and pump failure.

3.3.1 Power Supply Wiring

 **WARNING**

The pump must be connected to electrical supply with a suitable circuit breaker. (lockout / tagout CB).

 **WARNING**

Be sure to connect the grounding wire.

 **CAUTION**

Use the correct wiring materials and size to match the operating conditions in accordance with the power consumption rating and ambient air temperature of the pump.

The pump must be connected a suitable earth point.

 **WARNING**

The earthing of the pump is realized by connecting the cable with qualified electricians. The qualified electricians should have themselves a connection in the ground.

A : For model EV-A10-2*-P (1Phase 200V)

Use the power cable with ground. Insert the power cable in the grounding power outlet.

⚠ WARNING
Do not use the power cable adapter.

Fig. 3.1 shows details of the front panel of model EV-A10-2-P*.

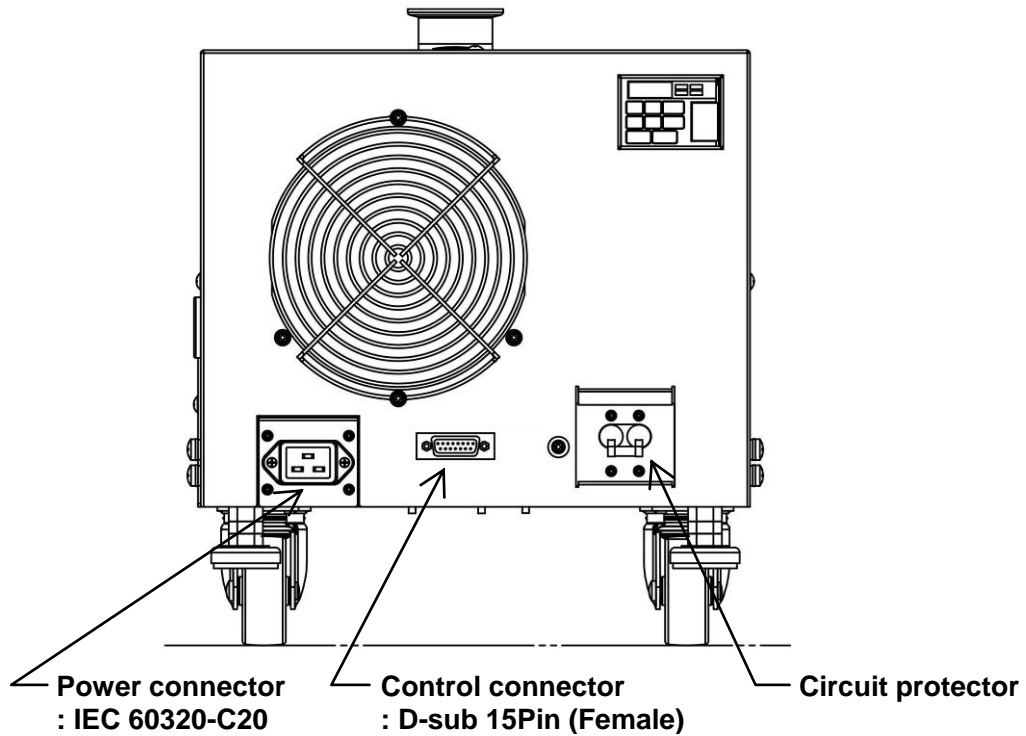

Fig. 3.1 Details of the front panel of model “EV-A10-2*-P”

Connect the power connector for the main power supply (1Phase, 200-240V ± 10% and 50/60Hz). The power connector type is “IEC 60320-C20”. Fig.3.2 shows the pin assignment of the power cable. Table 3.1 shows the receptacle and plug specifications.

- ✓ The connector type of the power cable is “IEC 60320-C19”.
- ✓ Use the power cable which suits “IEC 60320-C19”.
- ✓ Transit overvoltage on power supply : Installation category 2 of “IEC 60364-4-443”.

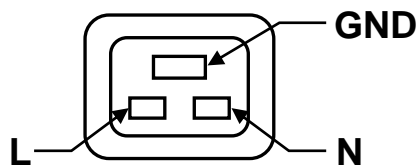

Fig. 3.2 Power Supply Receptacle (As seen from connecting side)

Table 3.1 Receptacle and Plug specifications

Receptacle type	PX0596/63
Recep. Manufacture	BULGIN
Recommended adapted plug type	PX0599
Suitable wire	AWG #14
Power capacity [kVA]	3.0

B : For model EV-A10-3*-P (3Phase 200V)

Fig. 3.2 shows details of the front panel of model EV-A10-3*.

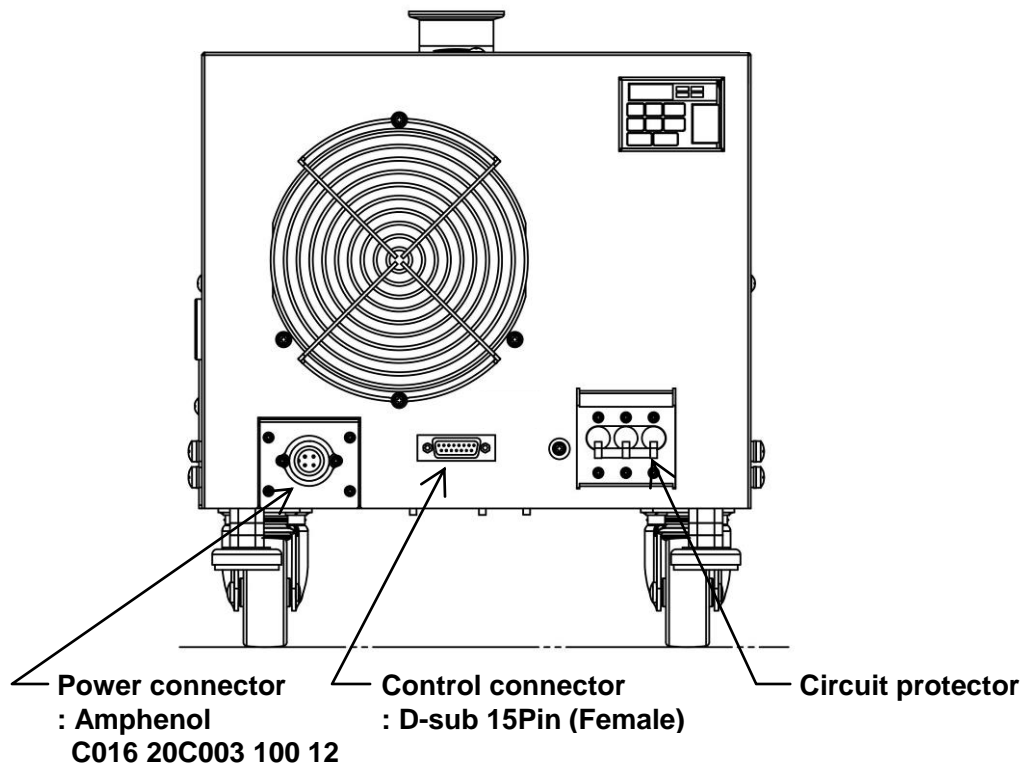

Fig. 3.3 Details of the front panel of model “EV-A10-3*-P”

⚠ WARNING

Model EV-A10-3*-P must be connected to electrical supply with a suitable circuit breaker (CB); 3-Pole, 15A.

CB shall meet the relevant requirements of IEC 60947-1 and IEC 60947-3.

It must be suitably located and easily reached, and marked as the disconnecting device for the pump.

Connect the power connector for the main power supply (3Phase, 200-240V ± 10% and 50/60Hz).

Fig. 3.4, Table 3.2 and 3.3 show the pin assignment of the power connector.

Connector pin is a screw fix type. Please make sure to tighten the screw enough to fix the connector pin.

Please wire the connector pin by the specialized tool.

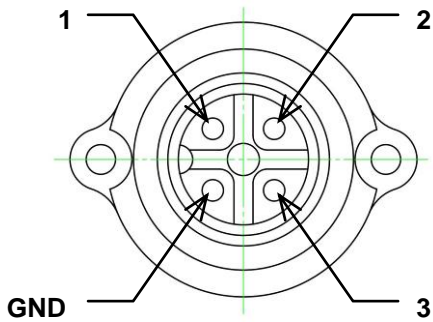

**Fig. 3.4 Power Supply Receptacle
(As seen from connecting side)**

No.	Phase
1	R
2	S
3	T
GND	GND

**Table 3.2 Pin Assignment of
Power Supply Receptacle**

Table 3.3 Receptacle and Plug Specifications

Receptacle type	C016 20C003 100 12
Recep. Manufacture	Amphenol
Adapted plug type	C016 20D003 100 12
Suitable wire	AWG #14
Power capacity [kVA]	3.0

3.3.2 Control Signal Wiring

Connect wires to the control connector for remote operation and remote monitoring.

Fig.3.5, Table 3.4 and 3.5 show the pin assignment.

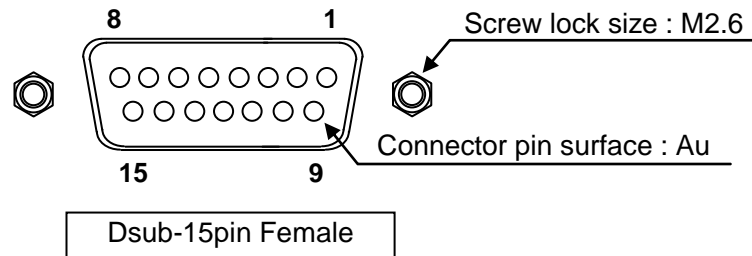

**Fig. 3.5 15 Pin D sub-Miniature Female Receptacle
(As seen from connecting side)**

Table 3.4 Control Connector Pin Assignment

Pin. No.	Signal name	I/O	Signal type
1	PUMP RUN (+)	INPUT	RUN : CLOSE
2	ALARM RESET (+)	INPUT	RESET : CLOSE, Alternate [note 1]
3	PUMP RUN/STOP STATUS (+)	OUTPUT	RUN : CLOSE
4	PUMP SPEED CONTROL MODE (+)	INPUT	CONTROL MODE : CLOSE [note 2]
5	---		
6	ALARM STATUS (+)	OUTPUT	ALARM : OPEN
7	PUMP SPEED CONTROL (+)	INPUT	DC 0-10 V [note 2]
8	---		
9	PUMP RUN (-)		[note 3]
10	ALARM RESET (-)		[note 3]
11	PUMP RUN/STOP STATUS (-)		
12	PUMP SPEED CONTROL MODE (-)		[note 3]
13	---		
14	ALARM STATUS (-)		
15	PUMP SPEED CONTROL (-)		

[note 1] RESET needs continuing signal over 5msec.

[note 2] With Pin 4-12 close, the pump rotation speed is directly proportional to the applied voltage between Pin 7-15. When 10V is applied, the pump rotation speed is maximum.

[note 3] 9, 10 and 12 pins are short-circuited by internal wiring.

Table 3.5 Signal contacts

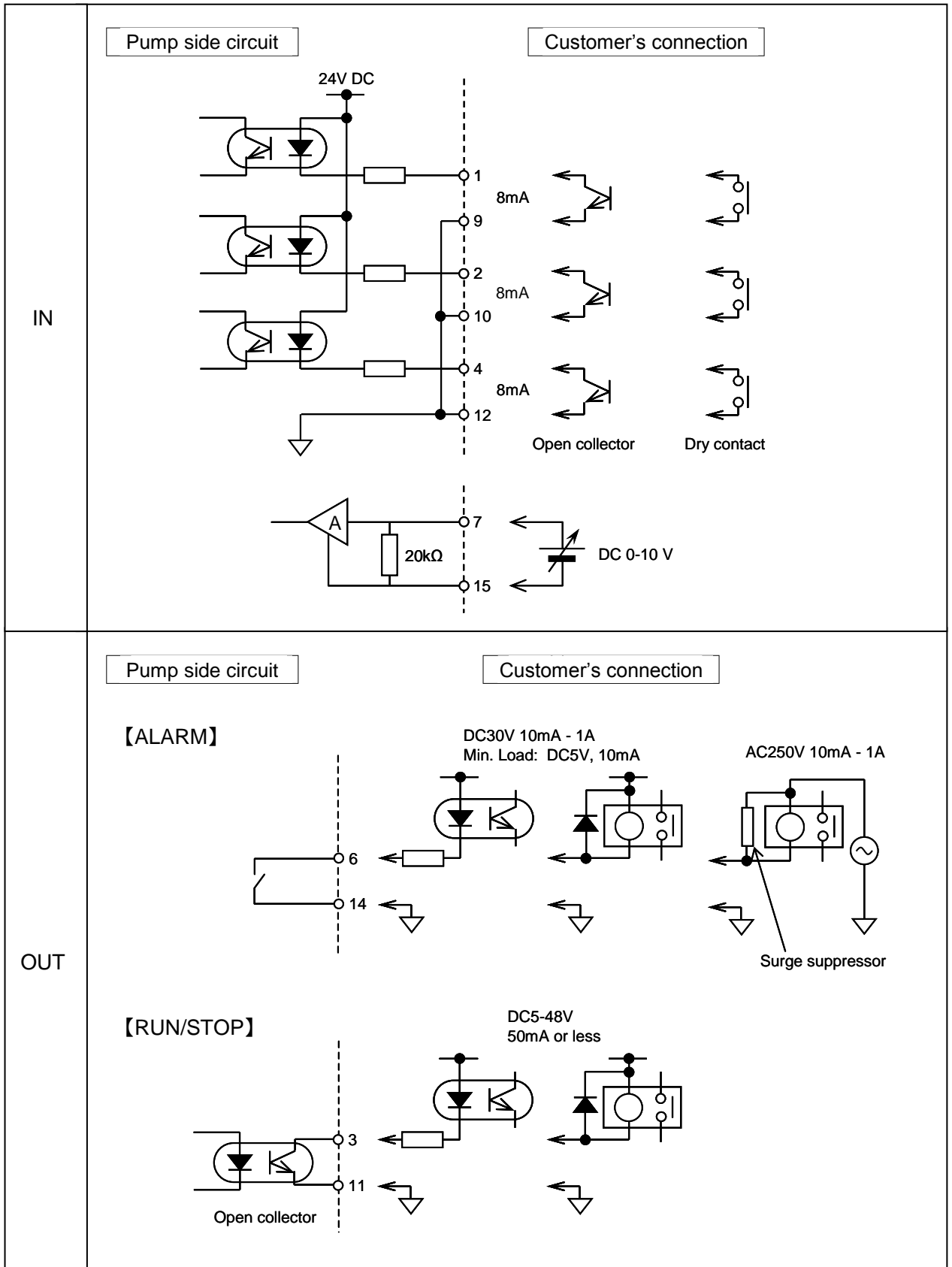

NOTE

Do not wire vacant pins.

NOTE

Apply a 24V DC power for input signals on the pump side. Do not apply this voltage on the equipment side.

NOTE

Conditions of output contact depend on those signals. Apply suitable voltage for each contact; relay or open collector outputs.

NOTE

Be sure to wire all signals with the correct polarity (+/-).

NOTE

When output signals are used to energize an inductive load such as a relay, be sure to insert a diode (100V / 1A class) in order to absorb the back electromotive force due to surge current.

4. Operation Panel

4.1 Operation Panel Outline

Running status can be checked by Data screen on the operation panel.

Fig.4.1, Table 4.1 and 4.2 show the Operation Panel, Push button switch, and LED Lamp.

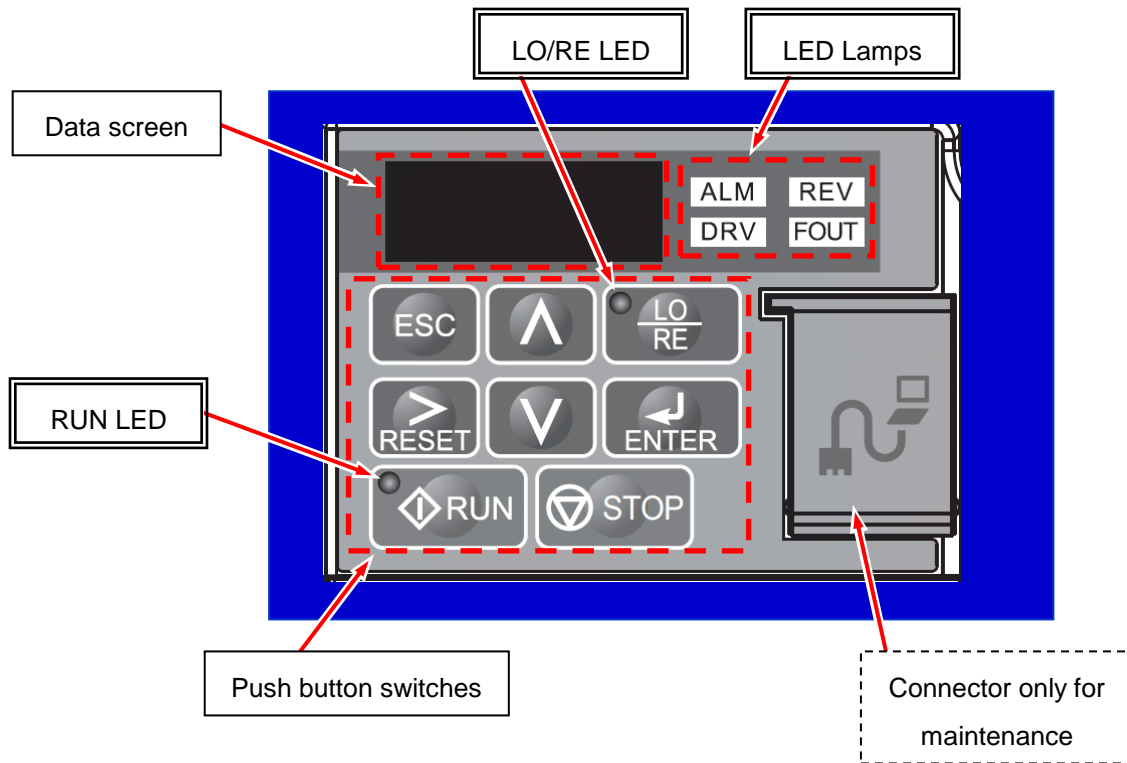

Fig. 4.1 Operation Panel

NOTE

Do not open the connector cover. The connector is only for maintenance. Do not connect another equipment with cable; such as LAN cable that has been on the market. The connection may cause failure of the equipment or the pump.

NOTE

When monitoring the operation panel, take care not to become unusual postures.

Table 4.1 Push button switches on the operation panel













Button	Name	Function
	RUN button	Start the pump. [note] This button works in the LOCAL mode.
	STOP button	Stop the pump. [note] This button works in the both mode LOCAL and REMOTE.
	UP/DOWN button	Change data screen
	ESC button	Return the previous menu.
	RESET button	Reset a fault situation.
	LO/RE button	Switch between LOCAL and REMOTE.
	ENTER button	Non-used

Table 4.2 LED Lamp on the operation panel

LED	Lit	Flashing	OFF
	Pump is running.	During deceleration to stop	During stop
	The operation mode is LOCAL.	---	The operation mode is REMOTE.
	Pump is ready.	---	Pump is not ready. [note 1]
	ALARM condition is occurred.	Minor failure is occurred.	Normal state (no fault or alarm)
	During displays the Rotation speed of the pump [min^{-1}]	---	---
	Never lit. [note 2]	---	---

[note 1] If the lamp is turning off, push ESC button several times and turn on.

[note 2] If the lamp is turning on, stop the pump immediately and contact us.

Table 4.3 shows seven-segment display character representations.

Table 4.3 Seven-segment Display Character Representations

Text	Display	Text	Display	Text	Display	Text	Display
0	<i>0</i>	9	<i>9</i>	I	<i>l</i>	R	<i>r</i>
1	<i>1</i>	A	<i>A</i>	J	<i>J</i>	S	<i>5</i>
2	<i>2</i>	B	<i>b</i>	K	<i>k</i>	T	<i>T</i>
3	<i>3</i>	C	<i>C</i>	L	<i>L</i>	U	<i>U</i>
4	<i>4</i>	D	<i>d</i>	M	<i>m</i>	V	<i>v</i>
5	<i>5</i>	E	<i>E</i>	N	<i>n</i>	W	<i>w</i>
6	<i>6</i>	F	<i>F</i>	O	<i>o</i>	X	none
7	<i>7</i>	G	<i>G</i>	P	<i>P</i>	Y	<i>y</i>
8	<i>8</i>	H	<i>H</i>	Q	<i>q</i>	Z	none

4.2 Operation Panel Display

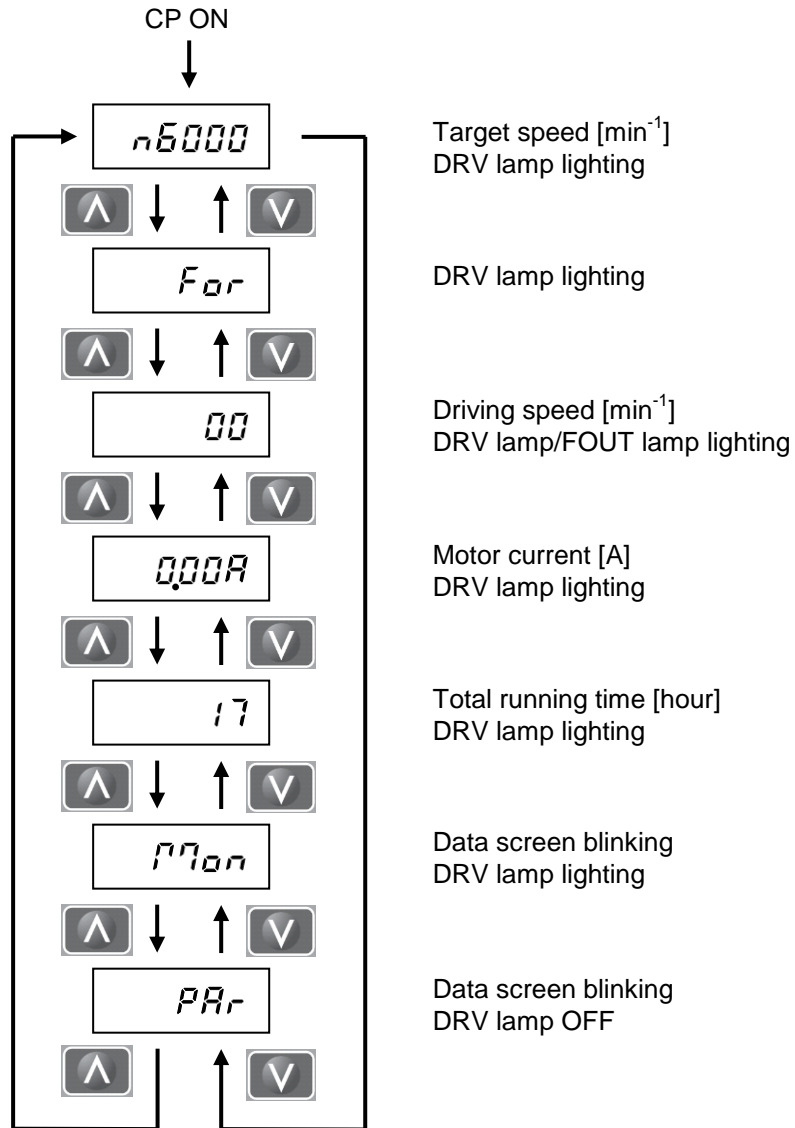

The information of the pump or the ALARM status is displayed on the data screen of the operation panel.



RE/LO LED is lighting in Local mode.

The pump will not be able to change the direction of rotation.

NOTE

Do not push , or the inverter settings might be changed. Push  button several times to come back to status screen, if the screen shows information other than above. If the setting is changed, the pump specification or control system can't be guaranteed.

When any ALARM occurs the pump will be stopped and the ALM lamp will immediately turn on or blink. The data screen will be changed to the ALARM display shown in Table 4.4.

The pump cannot be restarted until the pump meets the requirement for recovery.

Table 4.4 ALARM list ^[note 1]

No.	Display	ALM lamp	Description	Requirements for recovery
1	<i>oC</i>	Lit	“Over-Current” Inverter output current is too large.	Normalized + Reset signal input.
2	<i>ou</i>	Lit	“Over-voltage” Inverter inner voltage is too high.	Normalized + Reset signal input. [note 2]
3	<i>Uu1</i>	Lit	“Under-voltage” Inverter inner voltage is insufficient.	Normalized + Reset signal input. [note 3]
4	<i>Uu2</i>	Lit	Inverter control powers are in trouble.	Normalized + Reset signal input.
5	<i>Sfo</i>	Lit	Motor step out.	Reset signal input.
6	<i>oH</i>	Lit	Inverter is overheated.	Normalized + Reset signal input.
7	<i>oL3</i>	Lit	“Over-Load” Pump load is too large.	Normalized + Reset signal input.
8	<i>oL4</i>	Lit	“Over-Load” Pump load is too large.	Normalized + Reset signal input.
9	<i>EF4</i>	Lit	“Motor Overheat”	Normalized + Reset signal input.

[note 1] The ALARM is described in this list are typical alarm. If the alarm other than these is displayed, please contact EBARA.

[note 2] Under Over-Voltage (OV) condition the inverter retries automatically. After several times retry the condition is still bad, the data screen will display as Table 4.3 and pump will be stopped.

ALM lamp and “*ou*” display on the data screen are blinking for OV retry process.

[note 3] Under-Voltage (UV) condition is kept for less than 1sec, the inverter condition is returned to before UV ALARM occurred.

ALM lamp and “*Uu*” display on the data screen are blinking for UV condition.

5. Operation

5.1 Before Starting

- (1) Turn on the power supply to the pump.

**WARNING**

The pump must be connected to electrical power supply with a suitable circuit breaker.
(lockout/tagout CB)

**WARNING**

CB is not installed in the pump unit. Please install CB based on then law and the standard in the installation region.

- (2) Place the Circuit Protector (CP) into the ON position.

**WARNING**

The pump starts immediately after the inverter on-delay time if the CP turns on with remote RUN signal in Remote mode. Make sure the pipings are connected properly. Execute the safety preparations against sudden start the pump.

NOTE

Because of the inverter on-delay time, RUN command will be void for a few seconds after the CP turns on.

- (3) When the ALM lamp lights or any abnormal symptoms occur, take action in accordance with Section 9 “Troubleshooting”. Even when the cause of ALARM display has been removed, it is maintained until the Reset signal is entered. Either press the RESET button or enter an external Reset signal from the control signal connector.

- (4) When the pump exhaust pipe is equipped with a valve, open this valve before starting the pump.

**CAUTION**

Operating with the closed valve on the exhaust will pressurize the exhaust and cause problems for the pump.

5.2 START / STOP

The control mode can be set Local/Remote at any time by LO/RE button. (See Fig. 5.1)
After stopping the pump, set in accordance with the operating conditions.

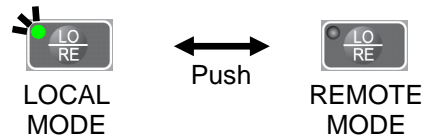



Fig. 5.1 Switching Between LOCAL and REMOTE

a) START

【LOCAL MODE】

Push  and select "LOCAL MODE".

After checking that the LO/RE lamp is ON, push  .

The pump will start and the RUN lamp will be ON.

【REMOTE MODE】

Push  , select "REMOTE MODE" .

After checking that the LO/RE lamp is OFF, input RUN signal from the control connector.

(See table 3.1)

The pump will start and the RUN lamp will be ON.

[NOTE] All buttons are located on the operation panel.

[NOTE] The pump will not start when an ALARM has been generated.

[NOTE] The control mode cannot be selected during RUN lamp is ON.

WARNING

The pump starts immediately after the inverter on-delay time if the CP turns on with remote RUN signal in Remote mode. Make sure the pipings are connected properly. Execute the safety preparations against sudden start the pump.

CAUTION

If the pump does not start smoothly, the exhaust gas may be backstreaming from the outlet port. Please check the system condition and retry the start process.

NOTE

Do not exhaust the process gases until at least 30 minutes after the pump has been started. The pump casing temperature will stabilize after about 2 hours and it is recommended not to start exhausting the process gases earlier than this.

b) STOP

【LOCAL MODE】

After checking the LO/RE lamp is ON, push .

【REMOTE MODE】

After checking the LO/RE lamp is OFF, interrupt RUN signal from the control connector.

NOTE

Even if the operation mode is REMOTE MODE, it is able to stop the pump by pressing the STOP button.

The pump starts decelerating and the RUN lamp blinks.

The pump stops and the RUN lamp will be OFF.

**WARNING**

The pump and exhaust piping will remain at a high temperature during operation and for a short time after the pump has stopped. Be sure to avoid contact and keep inflammable substances out of reach. Do not remove the outer cover during operation.

NOTE

Be sure to stop by the STOP button or interrupt the RUN signal, and keep the pump power supply for at least one minute. If the CP places off to stop the pump, the electrical components of the inverter may be damaged.

c) Power OFF

After one minutes or more the RUN lamp turns off, confirm the pump is stopped surely and the CP placed in the OFF position.

The Uu display and ALM lamp blink, a few seconds after the CP placed in the OFF position.

After other a few seconds, the display and ALM lamp turns off.

NOTE

If the CP turns on under Uu blinking, $Uu1$ or $Uu2$ ALARM may occur.
Input RESET command to cancel the ALARM before restart the pump.

5.3 Pump speed control mode

The following is the pump operating procedures in “PUMP SPEED CONTROL MODE”.

- 1) Select “REMOTE MODE”. (See Section 5.2)
- 2) Enable “PUMP SPEED CONTROL MODE” with closing Pin 4-12 of the control connector.
(See Table 3.4)
- 3) Apply voltage (DC 0-10V) to Pin 7-15 of the control connector. (See Table 3.4)
- 4) Run the pump with closing Pin 1-9 of the control connector. (See Table 3.4)
- 5) The pump will start and the pump rotor will rotate at a rotational speed corresponding to the applied voltage.

Fig.5.2 shows the relation between the applied voltage and the pump rotation speed.

Fig.5.3 shows the time chart of pump speed control.

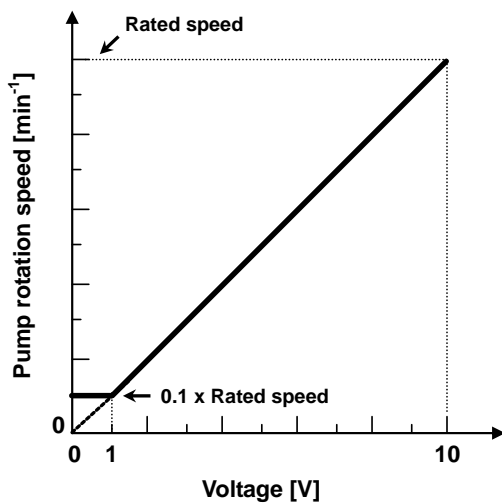

**Fig. 5.2 Applied voltage
– Pump rotation speed**

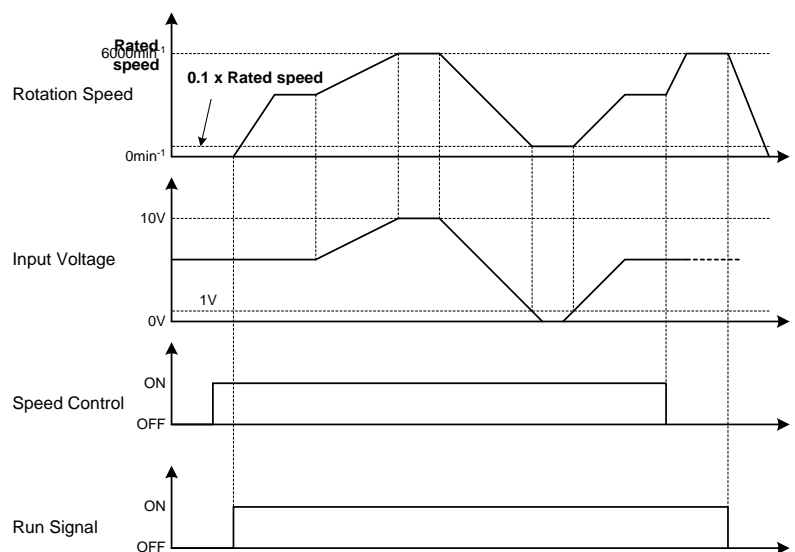

Fig. 5.3 Time chart

[NOTE] “PUMP SPEED CONTROL MODE” is a feature available only in “REMOTE MODE”.

[NOTE] The pump rotation speed is directly proportional to the applied voltage between Pin 7-15.

[NOTE] If the applied voltage is less than 1V, the pump rotation speed maintain “0.1 x rated speed”.

[NOTE] The pump rotation speed can be changed even during the pump operation.

[NOTE] If you disable “PUMP SPEED CONTROL MODE” during the pump operation,
the pump rotation speed will be changed to the rated speed.

[NOTE] The pump will not start when an ALARM has been generated.

[NOTE] The control mode (REMOTE / LOCAL) cannot be selected during RUN lamp is ON.

⚠ CAUTION

Do not apply voltage more than 10V. There is possibility that the pump to break down.

5.4 Operation when momentarily power failure happens

The momentarily power failure means that power supply voltage falls temporarily. The voltage of the interior DC circuit of the inverter, V_{PN} , falls to 190V or less due to the momentarily power failure, the inverter detects that the DC circuit Under-Voltage (UV). Pump operation continues when the V_{PN} returns to 190V or more within one second. Pump operation stops and the ALARM displayed when the momentarily power failure continues more than one second. Then ALM lamp turns on and data screen displays “UV 1” or “UV2”. In the momentarily power failure condition, pump rotor is driven by inertia due to interception of power supply. Thus, pumping performance may be decreased than guaranteed specification.

5.5 Nitrogen (N₂) Gas Purge

Operate the pump with the N₂ gas supplied to the purge port. As purge gas, it is possible to use the Clean Dry Air (CDA) by substitution of the N₂ gas, when pumping gas does not react with Oxygen.

Fig. 5.4 shows the positions of a purge port, a regulator, a pressure indicator, and a drain port.



WARNING

Please do not introduce explosive, flammable, toxic or corrosive gases into the pump.

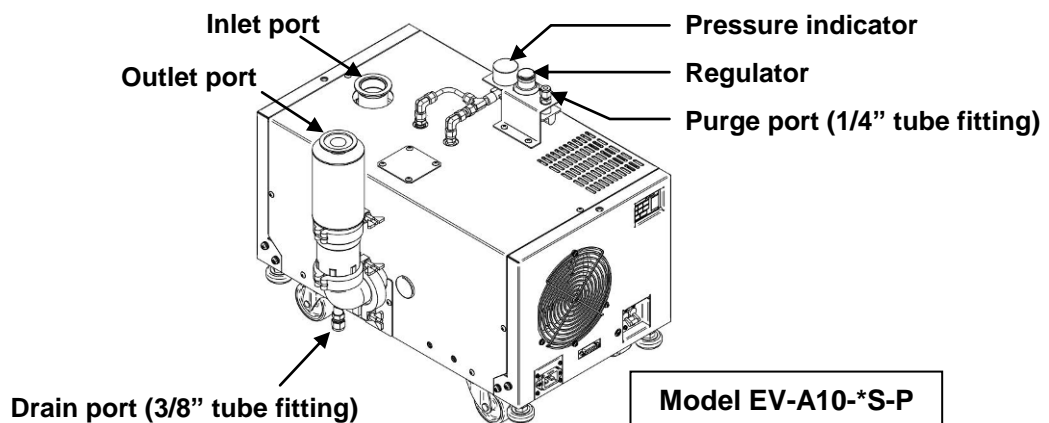

Fig. 5.4 Position of each equipment

- 1) Cut tube at right angles and make the end-face perfectly smooth. Then connect the tube to the tube fitting assembly of the N₂ gas purge port. The tube is a push-fit onto the shoulder of the tube fitting assembly.

Secure the tube fitting assembly properly and tighten the retaining nut by hand. After this, use a tool to tighten the nut further by 1+1/4 turns.

To reconnect the tube again after subsequent removal, install the tube already fitted to the ferrule and retighten the retaining nut slightly (about 1/4 turn) beyond hand tight.

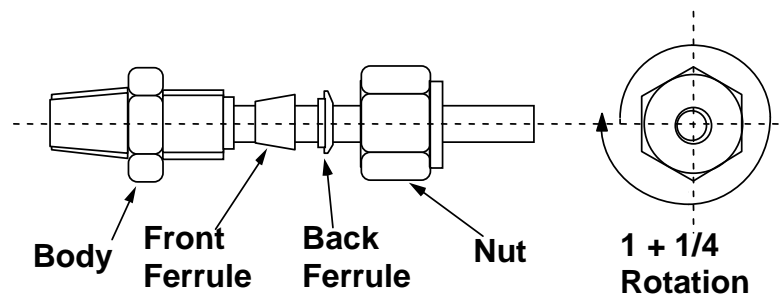

Fig. 5.5 Tube Fitting Assembly

2) Check that the regulator attached to the pump is closed.

i.e. The pressure adjustment knob is fully counterclockwise.

Open the main valve and check that there are no N₂/CDA leaks from the pipe connections.

Slowly turn the pressure adjustment knob clockwise to set the pressure (gauge pressure) to 0.1MPa. Then press the red stopper to lock the knob in position.

 **CAUTION**

Abrupt rotation of the pressure adjustment knob will cause the pressure indicator needle of the regulator to wobble and result in an inaccurate pressure display.

 **CAUTION**

Unless a sufficient supply of the purge gas is maintained, serious problems will occur such as pump corrosion and acceleration of reaction by-products.

 **CAUTION**

Be sure to use the purge system when operating the pump.

If the pump is operated without using the purge system, the oil may leak from oil reservoir to pumping area.

 **CAUTION**

Be sure not to react pumping gas with Oxygen, when CDA is used for purge gas.

NOTE

- It takes several tens of seconds after operating the regulator until the purge gas flow rate is stabilized.
- Condensed gas can be prevented from being condensed in the pump by introducing the purge gas.
- It is more effective if a pump is operated for 2 hours, introducing the purge gas after condensation gas introduction.
- When the pump is in low temperature, the effect of gas ballast is degrade. Before the introduction of condensable gas, please warm up the pump, 1 hour or more.
- The purge gas has different effect, depending on the pump operating temperature, the kind of condensable gas and its amount.
- On a regular basis, please discharge condensation liquid collected on into the exhaust pipe part from the drain port. (See Fig. 5.4)

6. Maintenance and Inspection

6.1 Routine Inspection

Check periodically that ALARM signal is not output on the panel or remote output. When the ALARM display appears, take action in accordance with Section 9. "Troubleshooting".

 **WARNING**

Be sure to turn off the power at the circuit protector (CP) and disconnect the power cable from the power connector, before the pump maintenance. Never supply power to the pump, until you have completed the pump maintenance.

 **WARNING**

The pump and exhaust piping will remain at a high temperature during operation and for a short time after the pump has stopped. Be sure to avoid contact and keep inflammable substances out of reach. Do not remove the outer cover during operation.

Even when the cause of the ALARM signal has been removed, the signal will be maintained until the RESET signal is entered. After you have taken the remedial action, press the RESET button on the panel or the RESET signal from the control signal connector to reset the ALARM.

 **WARNING**

When an ALARM signal has been generated in the REMOTE operating mode, do not start the maintenance tasks until you have interrupted the external RUN signal.

If any abnormal symptoms other than those displayed on the panel appear, take action in accordance with the instruction of Section 9. "Troubleshooting".

6.2 Vacuum and Exhaust Piping

Be sure to following the instructions below when carrying out maintenance work on the vacuum and exhaust piping of the pump..

- (1) Be sure to interrupt the power supply.
- (2) After you have washed the piping, do not reconnect until it has dried completely.

 **WARNING**

The pump casing, inlet piping and exhaust piping become extremely hot during operation and for some time after stopping. Be sure that pump and exhaust piping do not come in contact with humans or inflammable substances. Do not remove the pump cover during operation.

 **WARNING**

Be sure to check for gas leaks after you have finished pipe maintenance work. When checking for gas leaks by pressurization, please pressurize by less than 0.05 MPa.

6.3 Lubrication Oil

Periodically, please check an oil level. Remove the cap on the side of the outer cover to check the oil level gauge.

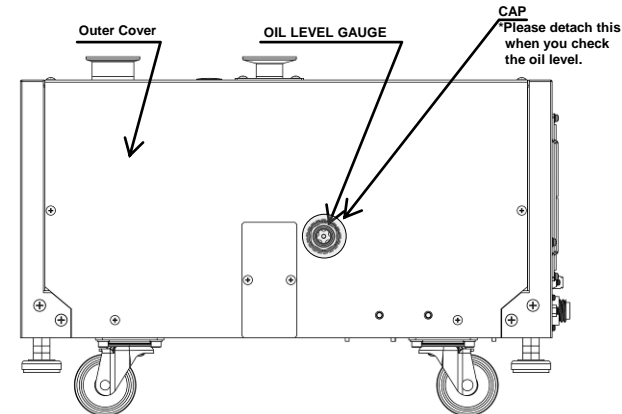

Fig. 6.1 Oil Level Gauge

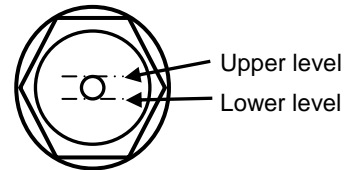

Fig. 6.2 Lubrication Oil Level

⚠ CAUTION

Fit the cap after you have checked the oil level.

If the oil level is lower than the lower limit line of the oil level gauge in daily inspection and maintenance, supply the oil is needed. Please refill the oil as following procedure.

- (1) Stop the pump and remove the Purge unit and the outer cover on the pump.(See Fig. 6.3, 6.4)

⚠ WARNING

Be sure to turn off the power at the circuit protector (CP) and disconnect the power cable from the power connector, before removing the outer cover on the pump. Never supply power to the pump, until you have completed the oil change.

⚠ WARNING

The pump casing, inlet piping and exhaust piping become extremely hot during operation and for some time after stopping. Be sure that pump and exhaust piping do not come in contact with humans or inflammable substances. Do not remove the pump cover during operation.

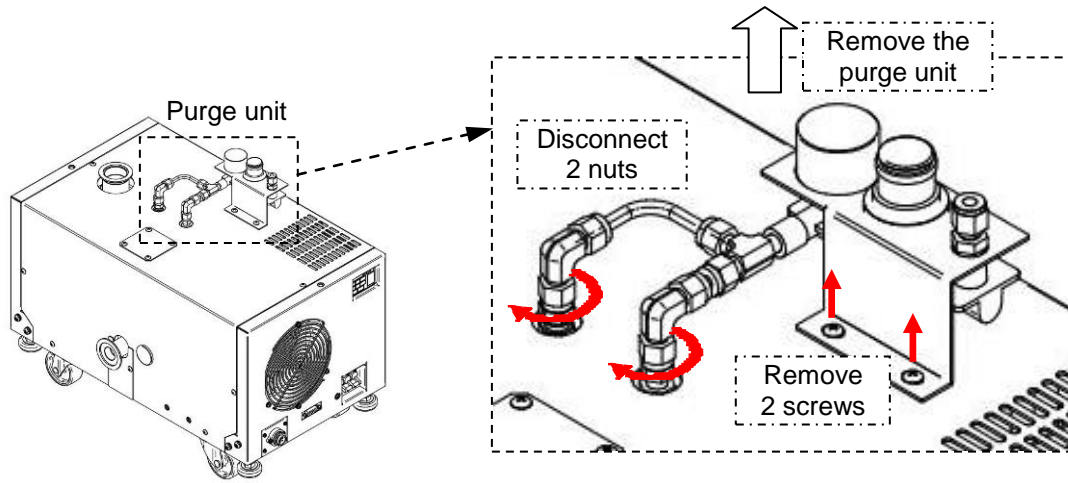

All the model (EV-A10-*S/*U-P) Common

Fig. 6.3 How to remove the purge unit

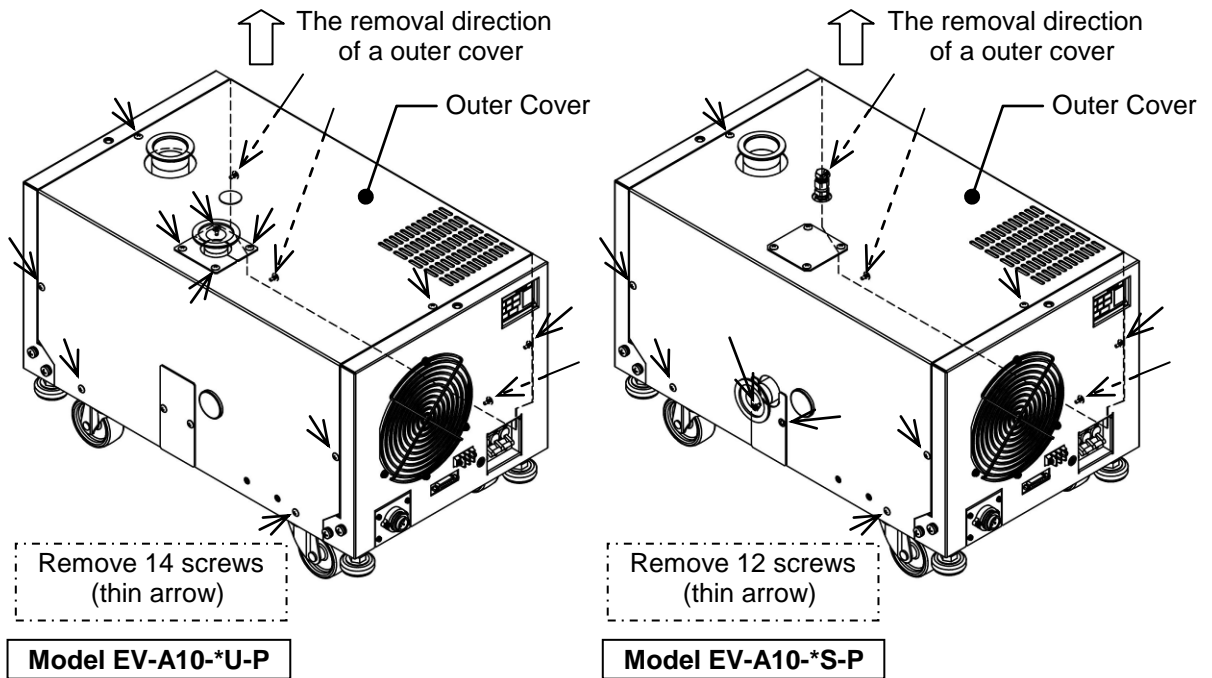

Fig. 6.4 How to remove the outer cover

- (2) After you have waited until the internal pump pressure returns to atmospheric (normal) pressure, remove the plug from the oil-inlet. (See Fig. 6.5)

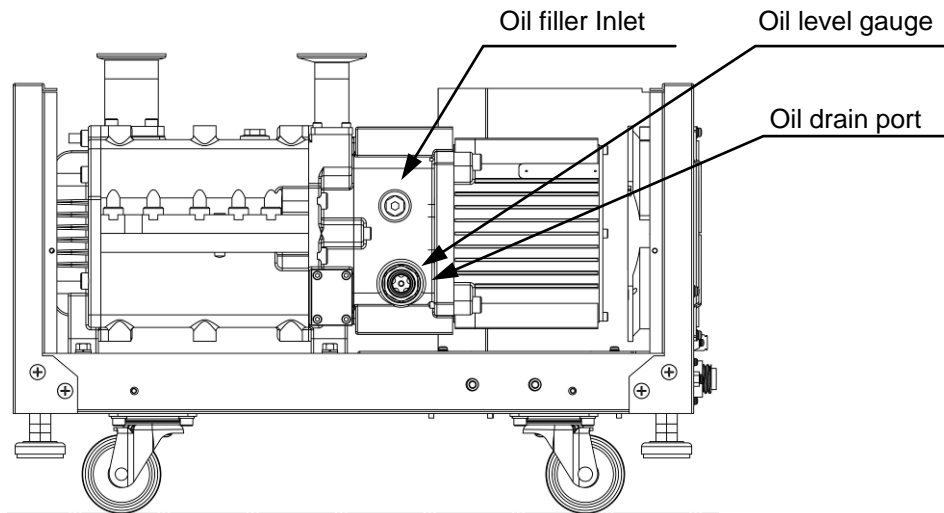

Fig. 6.5 oil filler inlet, oil level gauge, and oil drain port positions

- (3) Check the oil level from the sight-glass of the oil level gauge. Then add the lubricant oil so that the level is the upper level. (See Fig. 6.2 and 6.5)
- (4) After you have checked that there are no depositions and fragments adhering to the O-ring attached to the plug, close the oil-inlet.
- (5) Attached the outer cover and the purge unit on the pump.
- (6) Be sure to check the gas leak after supplying the lubricant oil.

⚠ WARNING

Be sure only to use the lubricant oil listed in specification table 6.1

⚠ WARNING

Waste oil shall be disposed of by industrial waste disposal dealer in accordance with Material Safety Data Sheets. (Appendix 1, 2)

⚠ WARNING

When the lubrication oil level exceeds the upper limit, the oil may leak to the pump side. Thus, be sure not to exceed the upper limit line when adding the oil.

⚠ WARNING

When the lubrication oil level is lower than the lower limit, serious failure may be caused. If you find out the shortage, add the oil immediately.

6.4 Maintenance Parts List

Following parts are needed for maintenance in customer's site.

Table 6.1 Spare (Maintenance) Parts List

1. Standard consumption Part.

Parts' Name	Type	Part No.
Lubricant oil	BARRIERTA J100ES	C-0402-000-0111

2. Recommendable Spare Part. (Not needed for each pump.)

Parts' Name	Type	Part No.
Oil level gauge	-----	C-5350-000-7900

Following labels are attached to pump covers. When they are hard to read for discoloring or peeling off, please stick them as directed.

Table 6.2 Labels

Label's Name		Part No.
[WARNING]	HAZARDOUS VOLTAGE WARNING LABEL	C-7110-313-0001
[WARNING]	HIGH TEMPERATURE WARNING LABEL	C-7110-312-0001
[DANGER]	HAZARDOUS WEIGHT DANGER LABEL	C-7110-316-0001
[CAUTION]	CHARGE MARK LABEL	C-7000-001-9600

6.5 List of Wastes During Maintenance

Table 6.3 lists wastes from general user maintenance. Dispose the wastes properly according to your local waste disposal regulations in each area.

Table 6.3 List of wastes during maintenance

Part	Equipped on	Remarks
Lubricant oil	Inside of pump module See section 6.3	Refer to Appendix 1, 2 for Material Safety Data Sheet
O-ring	Connection of vacuum line	Usual industrial waste

6.6 Repair and Service

If any abnormal symptoms other than those displayed on the operational panel appear, take action in accordance with the instruction of Section 9. "troubleshooting".

If trouble occurs, to order repairs or servicing. Please contact EBARA CORPORATION or an authorized Agent/Distributor, and provide the information on the nameplate and details of the problem. Please contact EBARA.

6.7 Overhaul

Overhaul is performed in EBARA.

Contact EBARA Sales office or Overhaul service center.

The Ebara EV-A10 pump may require periodic overhaul based on the application. Overhauls should only be completed utilizing Ebara factory trained personnel. Please contact Ebara for information on how to return your pump.

7. Storage / Disposal

7.1 Storage

If the pump is not used for a long period, proceed as following to store the pump.

- (1) Replace all gases inside the pump by purging them with dry Air or N₂ gas.
- (2) Seal off the inlet and outlet ports of the pump with blind flanges.
- (3) Store the pump in a dry and clean place.

Temperature : 5 to 40 deg C

Humidity : 80% or less (condensation must not exist)

7.2 Disposal

To disposal the unit, follow effective laws and ordinances applicable in the area where the unit is installed.

If you have any inquiries about the pump, please contact EBARA.

8. Disconnection and Transportation

 **WARNING**

When the pump has been used for exhausting highly toxic gases such as arsenic and mercury compounds, be sure to contact EBARA Corporation before you return the pump.

 **CAUTION**

In the interest of safety during the transportation, disassembly and cleaning of the pump, be sure to take note of the gases that have been handled.

Toxic gases may be generated from by-products in the piping or pump in pump disconnection from the tool piping for repair and replacement or flange removal for maintenance. Gain relevant information about the process gases from your tool suppliers, and be sure that the gas concentrations in the work areas are at quarter or under the acceptable values specified using appropriate measurement equipment.

Without assurance of gas safety, instruct the workers to wear proper personnel protective equipment if necessary to protect them from gas hazards. The personnel protective equipment must include at least gloves, safety goggles, and a gas mask.

To disconnect and transport the pump, proceed as follows.

- (1) Stop the pump and replace all gases inside the pump by purging them with dry clean air. When the pump has been used for toxic or flammable gases, replace all gases inside the pump by purging them with N₂ gas.
- (2) Switch off the power supply to the pump and remove the power and signal wires.
- (3) Remove the vacuum and exhaust pipes and completely seal off the suction and exhaust ports of the pump with a blind flange or similar seal. Seal off all process gas discharge points such as the differential port by using a blind flange.
- (4) Wrap the pump in a vinyl sheet.
- (5) Use the lifting eye bolts provided on the pump for slinging the pump to load and unload. Fasten eye bolts completely and push in until flush with the seating surface. For sling, use a wire with a length so that the slinging angle (that is, the angled subtended by the two wires) is within 60 degrees. (see Fig. 8.1)

 **DANGER**

Do not enter the zone underneath the suspended pump.

⚠ WARNING

For lifting the pump, use only qualified operator personnel.

Be sure that the wire rope and crane used for lifting the pump are in proper order and match the weight of the pump.

To prevent unequal weight distribution, suspend the pump by ensuring that the slinging angle remains symmetrically centered.

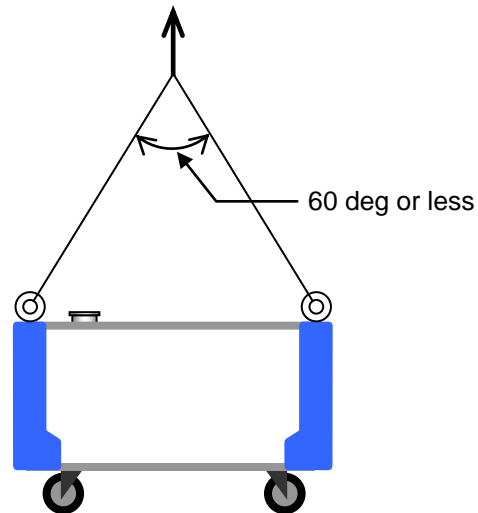

Fig. 8.1 Slinging the Pump

- (6) For transportation, secure the pump by lowering the adjustment feet. Place a protective cloth around the pump to avoid shock and position protective members between the outer cover and the wires in order to distribute the load of the fastening wires.

9. Troubleshooting

 **DANGER**

Be sure to keep the power supply to the pump turned off until you have finished the wiring and connecting work. Also remove the power connector and interrupt the Circuit Protector (CP) during this.

 **WARNING**

The pump and exhaust piping will remain at a high temperature during operation and for a short time after the pump has stopped. Be sure to avoid contact and keep inflammable substances out of reach. Do not remove the outer cover during operation.

 **CAUTION**

Be sure to check for leaks after you have installed and maintenance the pump.

9.1 Troubleshooting (1) : Basic trouble

Abnormal symptom	Check Item	Corrective Action
Circuit Protector is activated.	Incorrect wiring.	Check wiring.
	Short circuit.	Replace or overhaul pump.
Nothing appears on the operation panel.	No power supply to pump.	Check power supply.
	CP is not ON.	Place CP to ON.
	No wiring of power supply.	Connect power connector.
	Instrument failure.	Replace instruments.
Pump does not start when applying START button.	"Remote" mode has been selected.	Set switch to "Local" mode.
	Start-up conditions are not satisfied.	Satisfy all start-up conditions.
	Instrument failure.	Replace instruments.
Pump does not start when entering external "RUN" signal input.	"Local" mode has been selected.	Set switch to "Remote" mode.
	Start-up conditions are not satisfied.	Satisfy all start-up conditions.
	Instrument failure.	Replace instruments.
Pump starts suddenly.	"RUN" signal was input before CP turns ON.	Interrupt "RUN" signal before supplying power.
Abnormal noise. Excessive vibration	Adjustment feet are not applied.	Use the adjustment feet.
	Some object is making contact with the outer cover.	Remove the object.
	The fastening screws of the outer cover have worked themselves loose.	Tighten the fastening screws.
	Parts of the pump are damaged.	Replace or overhaul pump.
Vacuum pressure increase.	Leak from vacuum piping.	Check piping.
Rotation speed does not increase.	Pump overload.	Check pressure and exhaust pipe.
	Frequency order failure.	Tune instruments up.
	Parts of the pump are damaged.	Replace or overhaul pump.
	Supplied voltage failure.	Check power supply.

9.2 Troubleshooting (2) : ALARM

Abnormal symptom	Check Item	Corrective Action
Display appears $\alpha\bar{L}$ and ALM lamp lights.	Pump overload.	Check pressure and exhaust pipe.
	Parts of the pump are damaged.	Replace or overhaul pump.
Display appears $\alpha\bar{V}$ and ALM lamp lights.	Supplied voltage is overflow.	Input regular voltage.
	Exhaust gas is back-streaming.	Prevent reflux.
Display appears $\bar{U}U1$ and ALM lamp lights.	Supplied voltage is insufficient.	Input regular voltage.
	Incorrect wiring.	Check wiring.
	Momentary power failure occurs.	Check power supply.
	Instrument failure.	Replace instruments.
Display appears $\bar{U}U2$ and ALM lamp lights.	Supplied voltage is insufficient.	Input regular voltage.
	Instrument failure.	Replace instruments.
Display appears $\bar{S}\bar{r}\alpha$ and ALM lamp lights.	Exhaust gas is running back.	Prevent reflux.
	Parts of the pump are damaged.	Replace or overhaul pump.
	Pump overload.	Check pump load.
Display appears $\alpha\bar{H}$ and ALM lamp lights.	Inverter overheat.	Cool down inverter.
Display appears $\alpha\bar{L}3$ and ALM lamp lights.	Pump overload.	Check pump load.
	Parts of the pump are damaged.	Replace or overhaul pump.
Display appears $\alpha\bar{L}4$ and ALM lamp lights.	Pump overload.	Check pump load.
	Parts of the pump are damaged.	Replace or overhaul pump.
Display appears $\bar{E}\bar{F}4$ and ALM lamp lights.	Pump overload.	Check pump load.
	Ambient temperature is high (over 40 deg C).	Reduce the ambient temperature.
	Ventilation of the pump is blocked.	Open the space around the pump. (see section 2.1.2)
	Cooling fan stopped.	Replace or overhaul pump.

This page has been intentionally left blank.

製品安全データシート

MSDS No. 1863

作成日 2002年08月27日

改定日 2009年10月01日

1. 製品及び会社情報

製品名 : BARRIERTA J100ES

会社名 : NOKクリューバー株式会社

住所 : 東京都港区芝大門1-12-15 正和ビル

担当部署 : 品質管理部 品質管理課

TEL:0293-43-0426 FAX:0293-43-3817

2. 組成、成分情報

単一製品・混合物の区別 : 混合物

化学名 : フッ素系潤滑油

成分	CAS番号	官報公示整理番号	含有量
パーフルオロポリエーテル	企業秘密により開示不可	企業秘密により開示不可	>95wt%
添加剤	企業秘密により開示不可	企業秘密により開示不可	<5wt%

危険有害成分 : 非該当

3. 危険有害性の要約

最重要危険有害性 : 280℃以上に加熱すると、有害な（腐食性のある）分解ガスが発生する恐れがある。

有害性 : 280℃以上に加熱すると、有害な（腐食性のある）分解ガスが発生する恐れがある。

触媒となる金属等が共存する場合には、280℃以下でも分解することがある。

長時間における皮膚との接触により炎症を起こすことがある。

物理的及び化学的危険性 : 特になし

4. 応急措置

吸入した場合 : 大量に吸入した場合は、直ちに新鮮な空気のある場所に移し、保温して安静に保つ。必要なら医師の診断を受ける。

皮膚に付着した場合 : 付着物を拭き取り、水と石けんでよく洗う。かゆみや炎症などの症状がある場合は、速やかに医師の診断を受ける。

目に入った場合 : 清浄な水で最低15分間洗浄した後、医師の手当てを受ける。

飲み込んだ場合 : 無理に吐かせようとせず、直ちに医師の診断を受ける。

5. 火災時の措置

- 消火剤 : 本製品は不燃性。
霧状の強化液、泡、二酸化炭素、粉末が有効。
- 特定の消火方法 : 付近の着火源を断ち、保護具を着用して消火する。
- 消火を行う者の保護 : 消火作業の際には有害なガスを吸い込まないように呼吸用保護具を着用し、風上から消火作業を行う。

6. 漏出時の措置

- 人体に対する注意事項 : 暴露防止のため、保護具を着用して作業を行い、蒸気の吸入や皮膚への接触を防止する。必要であれば、十分に換気を行う。
漏出した場所の周辺への関係者以外の立ち入りを禁止する。
付近の着火源、高温体、可燃物を取り除き、消火機材を準備する。
- 環境に対する注意事項 : 本製品を含む廃水の公共用水域への排出又は地下浸透を防止するため、本製品がこぼれた床面などを水で洗い流してはならない。
- 除去方法 : 少量の場合はヘラ、スコップ等を使うか、土砂などに吸着させて蓋付きの空容器に回収し、ウエス等できれいに拭き取る。
火花を発生しない安全な器具等を使用する。
多量の場合は、土砂などで流れを止めた後で回収する。

7. 取り扱い及び保管上の注意

取り扱い

- 技術的対策 : 接触の恐れがある時は適切な保護具を使用する。
280℃以上に加熱したり、製品の付着した手で喫煙しないこと。
- 注意事項 : 原則として常温で取り扱い、その際、水分、夾雑物等の混入に注意すること。
- 安全取り扱い注意事項 : 暴露防止のため、保護具を使用して作業を行う。皮膚への接触を避ける。

保管

- 適切な保管条件 : 適切な換気のある乾燥した冷暗所に密栓して保管する。

その他、消防法、労働安全衛生法等の法令に定めることに従う。

8. 暴露防止措置及び保護措置

- 設備対策 : 屋内作業には適切な局所排気装置を使用することが望ましい。
- 管理濃度 : 規定なし
- 許容濃度 : 日本産業衛生学会(1993年版) 勧告値なし

保護具

- 呼吸器の保護具 : 有機ガス用防毒マスク
- 手の保護具 : 耐油性の保護手袋
- 目の保護具 : 側板付き普通眼鏡型またはゴーグル型保護眼鏡
- 皮膚及び身体の保護具 : 作業衣、安全靴

- 適切な衛生対策 : 作業中は飲食、喫煙をしない。

9. 物理的及び化学的性質

形状	: 液体
色	: 無色透明
臭い	: なし
比重	: 約 1.89 (20°C)
引火点	: なし (不燃物)
発火点	: なし (不燃物)
爆発限界 (下限)	: なし
爆発限界 (上限)	: なし
溶解性	: 水に不溶
蒸気圧	: 約 6.5E-5Pa (20°C)

10. 安定性及び反応性

安定性	: 通常の条件下では安定
反応性	: 特記すべき反応性なし
避けるべき材料	: 強塩基、アルカリ金属、アルカリ土類金属、ルイス酸
危険有害な分解生成物	: 280°C以上に加熱すると、有害な（腐食性のある）分解ガス（フッ素化合物）が発生する恐れがある。

11. 有害性情報

急性毒性	: 現在のところ知見なし
局所効果	: 長時間における皮膚との接触により炎症を起こすことがある。
変異原性	: 現在のところ知見なし

12. 環境影響情報

現在のところ知見なし

13. 廃棄上の注意

- (1) 知事等の許可を受けた産業廃棄物処理業者に処理を委託すること。
- (2) 空容器を廃棄する時は、内容物を完全に除去しておくこと。
- (3) 廃棄は法令に従い、適切に処理すること。

14. 輸送上の注意

注意事項 : 取り扱い及び保管上の注意の項の記載に従うこと。
容器漏れのないことを確かめ、転倒、落下、損傷のないように積み込み、荷崩れ防止を確実に行う。

国内規制

陸上輸送 : 消防法、労働安全衛生法等に定められている運送方法に従う。

海上輸送 : 船舶安全法に定められている運送方法に従う。

航空輸送 : 航空法に定められている運送方法に従う。

国連分類 : 非該当

国連番号 : 非該当

15. 適用法令

労働安全衛生法

表示対象物質 : 非該当

通知対象物質 : 非該当

その他 :

PRTR法

第一種指定化学物質 : 非該当

第二種指定化学物質 : 非該当

毒物及び劇物取締法 : 非該当

消防法 : 非該当

水質汚濁防止法 : 排出基準 : フッ素及びその化合物 (海域以外 : 8mg/L、海域 : 15mg/L)

輸出貿易管理令 : 別表1の5項 (先端材料)、別表1の16項 (キャッチボール規制)

16. その他の情報

(1) 引用文献 JIS Z 7250:2000 日本工業標準調査会

本製品安全データシートは、化学製品の工業的用途について、安全な取り扱いを確保するための参考資料として、一般的取り扱い等を前提として作成・提供されるものです。また、危険有害性の評価では現時点で入手した資料・情報・データ等に基づいて作成しておりますが、全ての情報を網羅したわけではありません。取り扱い事業者の皆様は、これを参考として、自らの責任において個々の取り扱いの実態に応じた適切な処置を講じる必要があることをご理解の上、お使い頂きます様、お願い申し上げます。

従って、本データシートそのものは、安全の保証書ではありません。
また、法令の改正および新しい知見に基づき改訂されることがあります。

Material Safety Data Sheet

Product name: BARRIERTA J100ES

Date: September 10, 2002

Revision Date: February 20, 2009

MSDS No. 1863

Page 1 of 5

1. Product and company identification

Product name: BARRIERTA J100ES

Company: NOK KLÜBER CO.,LTD

955-4, Aza Ohishi, Isohara, Isoharamachi, Kitaibaraki city, Ibaraki 319-1541, Japan

Telephone: +81-293-42-5365

Fax: +81-293-43-3817

2. Composition/information on ingredients

Chemical names and synonyms: Fluorinated lubricating oil

CAS No.	Components	Value
	Perfluoropolyether	>95wt%
	Additives	<5wt%

Hazardous ingredients:

3. Hazardous identification

>280 C traces of fluorinated products

Some materials (e.g. titanium, aluminum or alloys of these materials) may cause lower decomposition temperatures.

Prolonged skin contact may cause skin irritation and/or dermatitis.

4. First aid measures

After inhalation

Remove victim to fresh air. If symptoms persist, call a physician.

After contact with skin

Wash off with mild cleaners and plenty of water. If symptoms persist, call a physician.

After contact with eyes

Rinse with plenty of water. If symptoms persist, call a physician.

After ingestion

If large amounts are swallowed, do not induce vomiting. Obtain medical attention.

5. Fire-fighting measures

Suitable extinguishing media

The product itself does not burn. Use extinguishing measures that are appropriate to local circumstances and the surrounding environment.

Special hazards

In case of fire the following can be released: traces of fluorinated products

Special protective equipment for firefighters

Standard procedure for chemical fires.

Additional information

Water mist may be used to cool closed containers.
In the event of the fire and/or explosion do not breathe fumes.

6. Accidental release measures

Personal precautions

Risk of slipping due to leakage/spillage of product.

Environmental precautions

Do not flush into surface water or sanitary sewer system.

Methods for cleaning up/taking up

Use mechanical handling equipment. Dispose of absorbed material in accordance with the regulations.

7. Handling and storage

Handling

Advice on safe handling

No special handling advice required.

Advice on protection against fire and explosion

No special precautions required.

Storage

Requirements on storage conditions

Store at room temperature in the original container.

Incompatible materials

Do not store together with food.

8. Exposure controls/personal protection

Additional advice on system design

not applicable

Ingredients and specific control parameters

None

Personal protective equipment

Respiratory protection

No special protective equipment required.

Hand protection

Wear chemical-resistant gloves.

Eye protection

Wear safety glasses. Do not wear contact lenses when working with chemicals.

Body protection

Wear clean, body-covering clothing to minimize dermal exposure.

General protection and hygiene measures

Avoid prolonged and/or repeated contact with skin. Remove soiled or soaked clothing immediately. Clean skin thoroughly after work; apply skin cream. Keep away from tobacco products.

9. Physical and chemical properties

Form:	liquid
Color:	colorless
Odor:	none
Density:	approx. 1.89 g/cm ³ , 20°C
Flash point:	none °C
Ignition temperature:	not applicable °C
Lower explosion limit:	not applicable
Upper explosion limit:	not applicable
Water solubility:	insoluble
Vapor pressure:	approx. 6.5E-5Pa (20 C)

10. Stability and reactivity

Stability

Stable

Conditions to avoid

None

Materials to avoid

Strong bases, alkali metals, alkaline earth metals, Lewis acids

Hazardous decomposition products

>280 C traces of fluorinated products

Additional information

None

11. Toxicological information

The toxicological data has been taken from products of similar composition.

Acute toxicity: No data

Prolonged skin contact may cause skin irritation and/or dermatitis.

12. Ecological information

Information on elimination (persistence and degradability)

Product is insoluble in water. May be separated out mechanically in purification plants.

Behavior in environmental compartments

Ecological injuries are not known or expected under normal use.

Ecotoxic effects

Aquatic toxicity is unlikely due to low solubility.

Additional information

Should not be released into the environment.

13. Disposal considerations

This product can be incinerated when in compliance with local, state and federal regulations.

This product contains halogen.

Offer rinsed packaging material to local recycling facilities.

14. Transport information

UN class : not applicable

UN No.: not applicable

Advice on transportation

Not classified as dangerous in the meaning of transport regulations.

15. Regulatory information

Please refer to the law and local regulations, etc. in each country.

16. Other information

No information

The information provided in this Material Safety Data Sheet is correct to the best of our knowledge, information and belief at the date of its publication. The information given is designed only as a guidance for safe handling, use, processing, storage, transportation, disposal and release and is not be considered a warranty or quality specification. The information relates only to the specific material designated and may not be valid if the material is used in combination with any other materials or if it is processed, unless specified in the text.

エバラドライ真空ポンプ オーバーホール依頼書

宛先：		貴社名：
	行	部署名：
TEL No.		御氏名：
FAX No.		御住所：
		TEL：
		FAX：
		E-mail：

* 当社営業担当宛にFAX後ポンプに添付の上
御返却下さい。

お願い

弊社における、作業（分解、洗浄など）の人的安全および環境安全の確保のため、弊社の製品を御返却の際は、お手数ですが、必ずこの用紙で弊社に御連絡頂き、製品に添付して下さい。

貴社注文書番号、整理番号など：

1. ポンプ機名					
2. ポンプシリアル番号					
3. 付属品の有無	無 有（具体的に ）				
4. 装置名	（装置メーカー名）		（装置モデル名）		
5. プラズマ名	LP-CVD	PE-CVD	EPI	MO-CVD	ALD
	METAL-CVD	OXIDE-ETCH	POLY-ETCH		
	ASHING	PVD	ION-IMPLANTOR	SEM/METROGY	
	L/Lなど		その他（ ）		
	* エッチング、L / L等でも、As（ヒ素）を排出する可能性のある場合は、As排出と明記してください。				
	* Copper（銅）汚染が有る場合は営業に相談してください。				
6. 使用ガス名	* As（ヒ素）等、有毒性のガスを使用されている場合は必ず明記し、ポンプの吸排気口には閉止フランジを取り付けて下さい。明記なき場合、閉止なき場合はお引取を致しかねます。				
7. 電圧・周波数					
8. ポンプ停止時の状況					
9. 運転期間	年	月	日	～	年 月 日
10. オーバーホール後の状態	現状仕様 改造（手直し）希望（ ）				
11. 御返却日 / 引取り希望日	年	月	日	午前	午後
12. オーバーホール御希望納期	年	月	日	午前	午後
	* 予備機の有無（有、無）				
13. 備考					

Doc.No.7250-S32211Rev.2

Appendix 4 Overhaul/Repair Request (ENG)

Overhaul Request form (USA)

In the United States, returned pump shipments must conform to Department of Transportation regulations:

- Hermetically seal contaminated equipment in two heavy gauge polyethylene bags or equivalent.
- Tag or label equipment stating the possible hazardous material and/or the environment in which it was used.
- Obtain an RMA number from the EBARA Service department and post on all bags, containers, and packing list along with a copy of the Environmental Health & Safety Clearance Form. See next page for sample of the form.

Be sure to take these prior actions; otherwise Ebara refuses any overhaul services to avoid associated risks.

Appendix 5 Leak Check procedure

Typical Leak Check Procedure

NOTE: This general procedure is not a substitute for user's work instructions or leak detector operations manual. Read and follow the instructions for your leak detection apparatus.

Perform leak check after initial system assembly and after any breach of the system for maintenance.

Check pump down time (that is time to go from atmosphere to target pressure) of fore line to confirm the absence of gross leaks.

For vacuum systems and process pump exhaust lines, pressurize the system with helium and run the probe ("sniffer") of a mass spectrometer leak detector around all joints, seals and fittings.

Realign joints, tighten fittings, replace seals, etc.

Repeat as necessary to eliminate all leaks.

Disconnect helium supply and place system in operating condition.