

Chemtech Scientific provides access to this content as a courtesy.  
We do not own the content contained in this document.  
All rights and credit go directly to its rightful owners.  
[www.chemtechsci.com](http://www.chemtechsci.com)  
Call us at: 484-424-9415



# **INSTRUCTION MANUAL**

---

## **MULTI-STAGE DRY VACUUM PUMP**

**A70W (A70W-S, A70W-C)**

**A30W (A30W-S, A30W-C)**

**A25S (A25S-S)**

**A10S (A10S-S)**

**A07V (A07V-S)**

---

Do not reproduce or reprint any portion of this manual without permission.  
Manufacturer reserves the right to discontinue or change any specifications or designs  
without notice and without incurring obligations.

## Record of Changes

Rev.	Date	Page	Position	Contents	Reason
0	2-Jun-94			Newly issued	
1	13-Jul-94	5 6-10 14 17 21 22	A07V Spec. Outline Drawing Fig. 3.4 Fig. 4.2 Fig. 4.6 Table 4.5	Pumping Speed Water Sup./Rtn Sys. Flow Coupler Ctrl. Wiring Pin Assign.	Correction Add NPT Add Note Add Drawing Correction Add note
2	14-Nov-96	iii ,iv  v ,vi ,vii  4  21 25 26 33  35,36 37 44,45	Fig. 1,2,3,4,5  Drawing  3.3 List  Dig. 4.4 Table 4.6 Fig. 4.7 Table 6.1  6.3 7 (8) 9	Safety warning labels Warning label Location Detailed specifications Power Sup. Rec Dipswitch S.W setting Typical check items Spare Parts Pump Lifting Service Net.	Add  Add  Add List  Correction Design Change Design Change Add Table  Add List Add Note Add List
A	12-Dec-97				New release per ECO 2905
3	20-May-99	21 44,45  5,6,18, 27,28, 32	Tab. 4.2 9. Service Network  -----	Suitable wire Japan, Taiwan (Add., Phone, Fax) The Unit was changed in terms of Domestic regulation for Measurement low.	Correction Change  -----
3A	27-Apr-01				ETI release of EC Rev 3 per ECO 5394.
3B	June 2002	20  iv  Thruout		Add UL grounding note Add LCD "hot surface" note Add appendices Language Edit	Third-party marking Third-party marking SEMI S2 ECO 5771

## Safety Information

Anyone operating this pump must have the knowledge to identify and avoid hazardous conditions associated with the pump.

Rash actions or improper operation may cause dangerous accidents and serious injuries.

Before installation and operation, the operator first should have a thorough knowledge of the pump's construction, operating procedures, and hazards.

The operator should read this instruction manual and other documents issued by EBARA.

If you have any questions on pump operation, safety, or maintenance, please do not hesitate to contact EBARA directly.

Three terms in this manual designate different levels of hazard:



**DANGER**

indicates an imminently hazardous situation that, if not avoided, will result in death or serious injury.



**WARNING**

indicates a potentially hazardous situation that, if not avoided, could result in death or serious injury.



**CAUTION**

indicates an imminently hazardous situation that, if not avoided, may result in minor or moderate injury.

This term may also indicate situations that might damage equipment.

---

## Important Precautions



**DANGER**

Keep out from under the pump when it is elevated.



**WARNING**

Only qualified personnel should unload and lift the pump.



**WARNING**

Be careful not to overturn the pump when pushing or pulling it sideways. The pump is narrow in comparison to its height.



**WARNING**

Only a qualified electrician, observing all national and local regulations, should perform electrical work.



**WARNING**

Cut and lock out electrical power before beginning wiring or maintenance work.

Do not switch on the power supply to the pump until work is completed and pump and piping are back in safe operating condition.



**WARNING**

Supply N<sub>2</sub> gas to the exhaust piping when necessary to dilute flammable or toxic gases down to a safe concentration.



**WARNING**

Purge system with sufficient N<sub>2</sub> gas before removing and cleaning the vacuum lines and exhaust piping.

Prevent dispersal of flammable, toxic or dangerous materials and guard against their contact with the human body.

Work only in locations with an emergency escape route.



**WARNING**

Do not convert the pump from one process to another without an intervening overhaul. Gases or reaction products remaining in the pump may react and lead to accidents or to the formation of large amounts of byproduct.



**WARNING**

Check Safety Interlock functions periodically (every 6 months) to confirm correct operation. See Appendix 2 for a description of these interlocks.



**WARNING**

Connect exhaust from pumps handling process gases to an appropriate exhaust abatement system that is equipped with discharge quality monitors to provide warnings and to shut down the process gas flow if concentrations exceed allowable limits.



**WARNING**

Check for gas leaks after initial installation of the piping and after reassembly following maintenance or, at least, annually. Gas leaks can result in the discharge of harmful and dangerous substances and in abnormal reactions due to the admission of air into the pump. Replace o-rings as required to correct leaks. See Appendix 4.



**WARNING**

Do not modify the pump or any of its parts without EBARA's approval.



**WARNING**

Do not place the LCD controller on or near a surface with a temperature exceeding 65°C.



**WARNING**

The pump casing and exhaust piping become extremely hot during operation and remain hot for some time after stopping.

Keep pump and exhaust piping away from contact with personnel and flammable substances.

Do not remove pump enclosure panels during operation.



**CAUTION**

Disposal of process byproducts must be in strict accord with all local and national environmental and safety regulations.



**CAUTION**

Dispose of printed circuit boards containing lithium batteries in strict accord with all applicable local and national environmental regulations.



**CAUTION**

The height of EBARA dry pumps may place the EMO button and the LCD controller below the heights recommended in SEMI S8-95. See Appendix 3.

The following safety warning labels appear on the pump covers:

- High temperature warning
- Hazardous voltage warning
- Hazardous materials warning
- Electric charge mark
- Hazardous weight danger

High temperature warning

Hot surface may burn or cause injury.  
Allow the piping and casing to cool before servicing.



### Hazardous voltage warning

Hazardous Voltage may shock, burn, or cause death.

Turn power off and lockout before servicing.

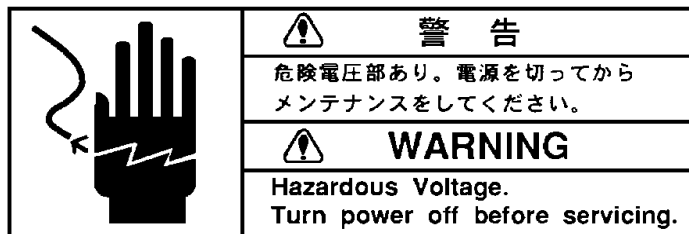

### Hazardous materials warning

(Applies only when pumping hazardous materials)

Run the pump only with N<sub>2</sub> gas purge before servicing.

Take adequate measures against dangerous reaction and contact with human body.

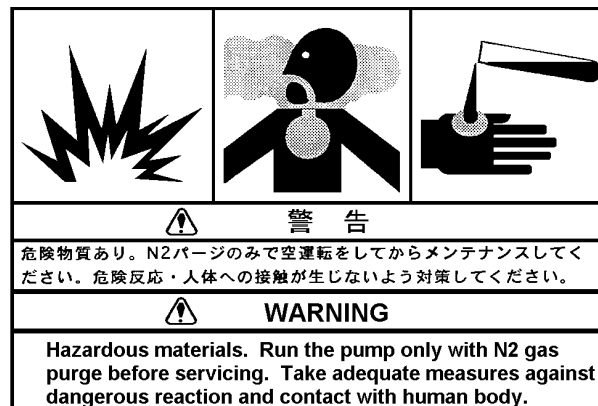

### Electric charge mark

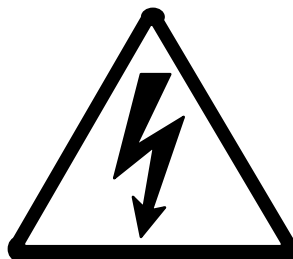

Hazardous weight danger

Heavy weight may cause severe injury or death due to overturning or falling pump.

Keep out from under the lifted pump.

Raise all adjuster feet fully when moving.

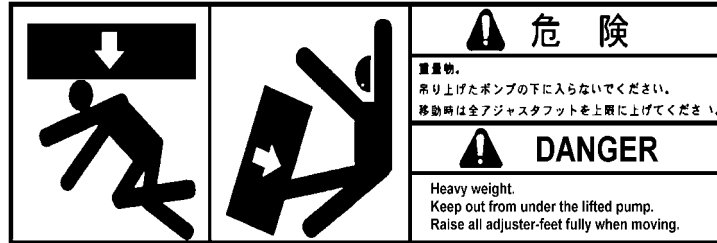



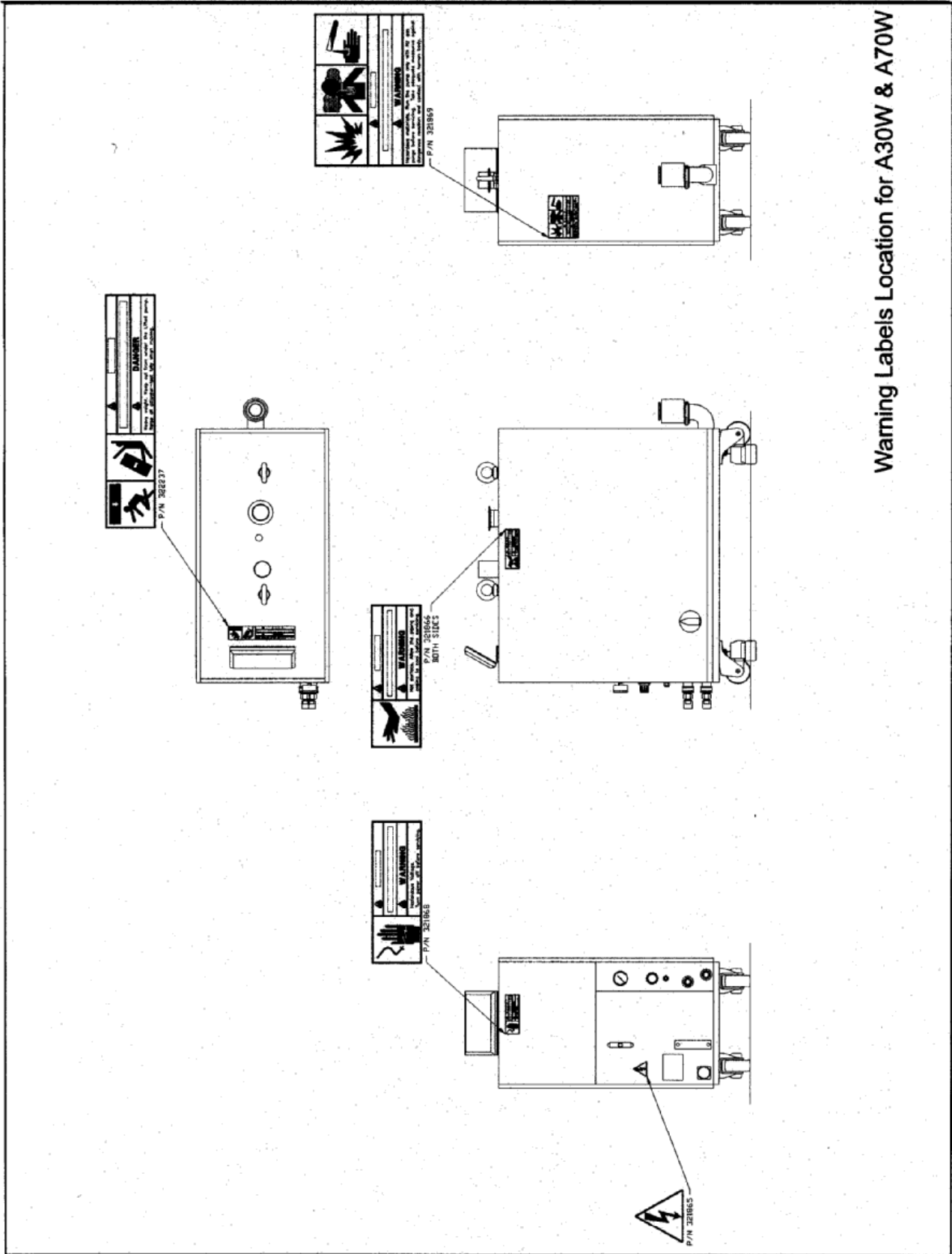

Warning Labels Location for A30W & A70W

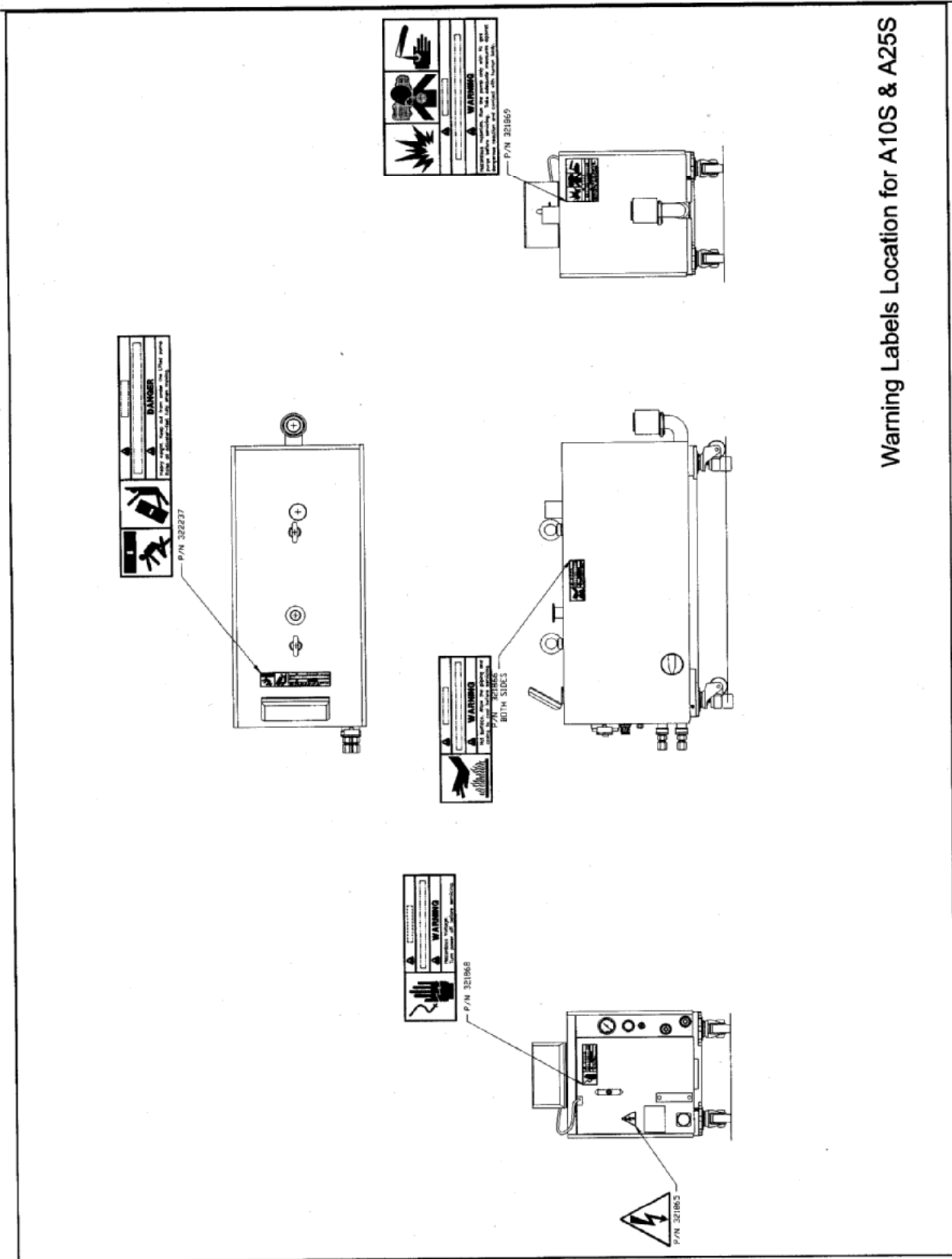

Warning Labels Location for A10S & A25S

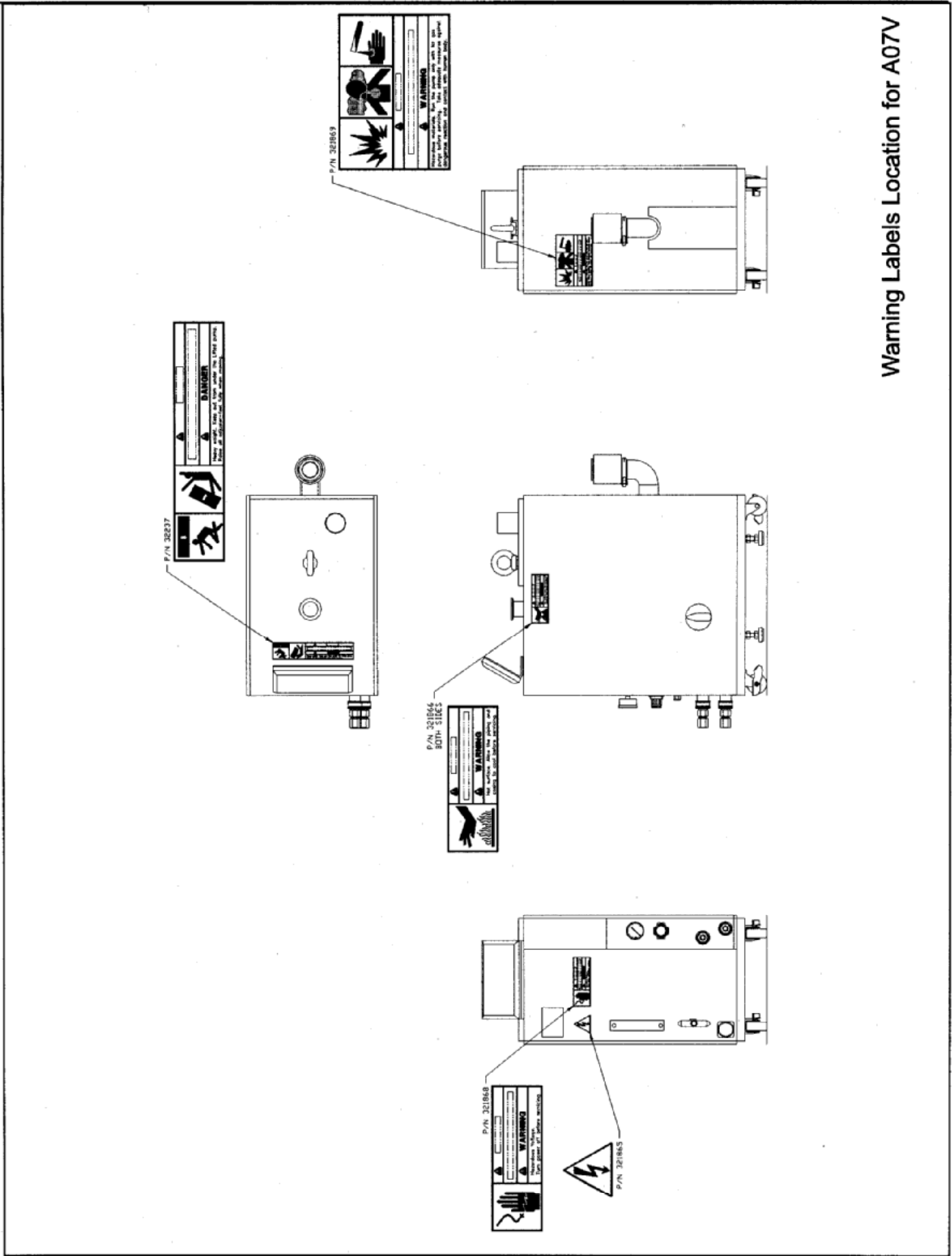

Warning Labels Location for A07V

## Contents

Record of Changes.....	i
Safety Information .....	ii
Important Precautions.....	iii
Contents .....	x
1 Foreword.....	1
2 Introduction .....	1
3 Product Description.....	2
3.1 Summary .....	2
3.1.1 Pump Module.....	2
3.1.2 N <sub>2</sub> Gas .....	2
3.1.3 Cooling Water.....	2
3.1.4 Exhaust .....	2
3.2 Control System.....	2
3.2.1 Warning.....	3
3.2.2 Operation Status Control.....	3
3.3 Moving the Pump.....	3
3.3.1 Preparation .....	3
3.3.2 Moving Method.....	4
3.4 Detailed Specifications .....	4
4 Installation .....	16
4.1 Location .....	16
4.2 Piping .....	17
4.2.1 Vacuum and Exhaust Piping .....	17
4.2.2 Cooling Water Piping.....	17
4.2.3 N <sub>2</sub> Gas Piping.....	19
4.2.4 Ventilation Duct.....	19
4.3 Electrical Wiring .....	20
4.3.1 Power Supply Wiring .....	20
4.3.2 Control Signal Wiring.....	21
4.4 Operation Mode .....	24
5 Operation .....	26
5.1 Before Starting.....	26
5.2 Operation .....	30
5.2.1 Local (Pump side) Operation .....	31
5.2.2 Remote (Distant) Operation.....	31
6 Maintenance and Overhaul.....	32
6.1 Routine Inspection .....	32
6.2 Piping Maintenance.....	33
6.3 Lubricant Oil .....	33
6.4 Spare (Maintenance) Parts List .....	34
6.5 Overhaul.....	35

---

<b>7</b>	<b>Removal and Transportation</b> .....	<b>36</b>
<b>8</b>	<b>Troubleshooting</b> .....	<b>38</b>
8.1	Troubleshooting (1) Basic Trouble .....	38
8.2	Troubleshooting (2) ALARM .....	39
8.3	Troubleshooting (3) TRIP .....	41
8.4	Troubleshooting (4) TRIP [Options] .....	42
<b>9</b>	<b>Inquiries</b> .....	<b>43</b>
9.1	North America .....	43
9.2	Asia .....	44
9.3	Europe .....	45

## **Appendices**

1.	Material Safety Data Sheet – Vacuum Pump Oil .....	I
2.	Safety Interlocks .....	III
3.	Ebara Dry Pumps and SEMI S2-93A (S2-0200) .....	V
4.	Leak Check Procedure .....	VI
5.	Returning pumps for Rebuild in U.S. ....	VII

---

## 1 Foreword

We appreciate your selection of an EBARA A Series dry vacuum pump. EBARA has manufactured this pump with much care and attention to permit safe and satisfactory operation.

Incorrect operation will result in lack of performance and may cause accidents and injuries to personnel.

**[NOTE]** This instruction manual contains necessary information on operation and maintenance of the pump.

Operate the pump correctly in accordance with these instructions to ensure a long service life.

Keep this instruction manual in a suitable place for immediate reference whenever needed.

## 2 Introduction

Check the following items on receipt of the pump package.

Check the nameplate affixed to the outer cover of the pump to confirm that the pump supplied agrees with your order.

Check the accessories against the packing list and the previously submitted drawings and documents to confirm that the all ordered accessories have arrived.

Check for damage and for screws/bolts that have worked loose in transit.



### CAUTION

Notify EBARA without delay when there is damage or when components are missing.

Do not use when a leak is present as this may result in an accident.

Store the pump in a dry and clean place until installation.

Temperature : 5 – 40 °C

Humidity : 80 % or less

Do not stack the pump. Place it in an upright position.

---

## **3 Product Description**

### **3.1 Summary**

The A Series dry vacuum pump has a compact design and includes various sensors and controls to enhance reliability and operation.

#### **3.1.1 Pump Module**

The pump is a roots-type vacuum pump that rotates a pair of non-contact, multi-stage rotors synchronized by timing gears. High-capacity units have a Booster Pump (BP) connected in series with the Main Pump (MP).

A compartment, isolated from the pump casing, encloses the timing gears and bearings, which require lubrication with Perfluoro-Polyether (PFPE) oil and grease.

The pumps of this series are factory-filled with lubricating oil. Replenish or replace only with the recommended oil grades shown in Specification Tables 3.1 and 3.2.

#### **3.1.2 N<sub>2</sub> Gas**

Pressurized nitrogen, supplied to the labyrinth seal section, isolates the vapor stream from the lubricated components, enabling the pump to draw a clean vacuum without admitting lubricant oil to the pump casing.

Additional N<sub>2</sub> gas, injected in various pump stages, reduces corrosion due to process gas and retards the accumulation of reaction byproducts. For processes that do not produce corrosion or reaction byproducts, the selector valve can stop completely the dilution N<sub>2</sub> flow. Adjusting the regulation pressure to the specified value supplies the correct amount of N<sub>2</sub> gas for these two types of purge operation.

The pumps of this series are equipped with a dilution N<sub>2</sub> gas control valve. Consult EBARA before adjusting the N<sub>2</sub> gas supply to the appropriate level for specific conditions of use. (Maximum dilution N<sub>2</sub> flow rate: 76 Pam<sup>3</sup>/s.)

#### **3.1.3 Cooling Water**

Compressing gas from vacuum to atmospheric pressure generates heat. Therefore, cool motors and casings with cooling water.

Quick-connect cooling water couplers make connection and disconnection easy.

#### **3.1.4 Exhaust**

The exhaust check valve, a standard accessory, prevents reverse flow of gas from the exhaust back through the pump to the vacuum chamber when pump stops. A silencer (optional) reduces exhaust noise.

### **3.2 Control System**

A Series dry vacuum pumps have a built-in sensing unit consisting of an Earth Leakage Breaker (ELB), an electro-magnetic switch and a control circuit or an overcurrent circuit breaker (CB). To improve reliability and safety, sensors monitor the condition of each utility

---

and pump section.

During pump operation the central processing unit monitors all operating conditions, including power supply, cooling water flow, N<sub>2</sub> gas flow, lubrication oil level, casing and motor coil temperature, motor current and suction pressure.

Pump operation “rides through” a transient power outage up to 500 milliseconds long. (Two-second ride through is available as an option.)

### 3.2.1 Warning

To improve the reliability of the vacuum exhaust system, the pump control scheme generates two levels of trouble warning: ALARM and TRIP.

An ALARM signal draws attention to an operating parameter value that has exceeded the normal operating range; it does not signify that danger is imminent. The pump will continue to operate in this condition, which enables the operator to complete the wafer cycle before checking the pump.

The pump will stop automatically and generate a TRIP signal output if a parameter approaches a mechanical safety limit.

Contact EBARA Corporation for details on checking the ALARM and TRIP setting conditions.

### 3.2.2 Operation Status Control

To facilitate operation status control and daily inspection, the LCD controller displays the sensor data.

The LCD controller displays all ALARM and TRIP signals. For remote operation and monitoring, the signals are available individually and as collective outputs.

## 3.3 Moving the Pump

### 3.3.1 Preparation

Raise all four adjuster feet fully before moving the pump; otherwise, an obstacle on the floor may cause the moving pump to tip over.

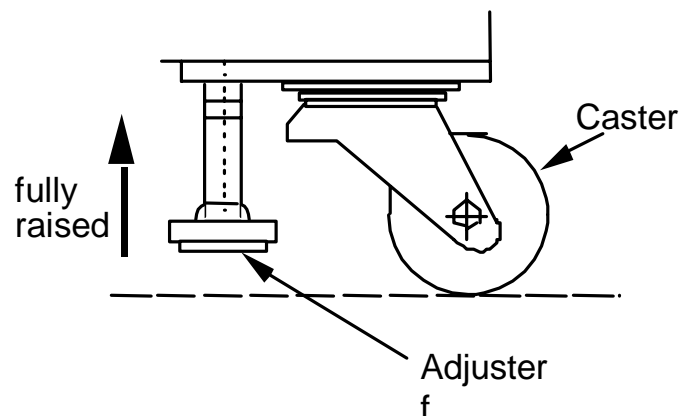



### 3.3.2 Moving Method

Move pump slowly by pushing eyebolt along the long axis of the pump (Direction A). Keep toes and fingers away from moving wheels. If placing the pump in a corner or narrow space requires moving it along the short axis (Direction B), two persons should “walk” the pump over by alternately pushing the ends as shown below.

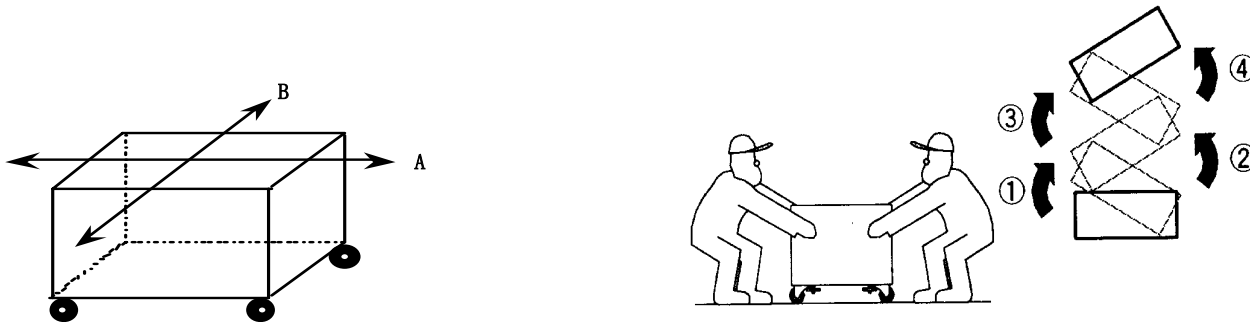

To move the pump across cracks or joints in the floor, spread a steel plate or similar device, which can sustain the pump’s weight, over the discontinuity. At least two persons, using great caution, should move the pump.

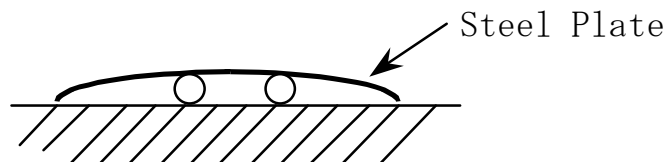

**DANGER**

If, when moving a pump, it loses balance and starts to tip over, do not attempt to stop it. Get away from the pump immediately and let it fall.

### 3.4 Detailed Specifications

Refer to the following tables and figures for detailed specifications, size, and pump performance.

#### List of Tables and Figures

Category	Contents	Page
Table 3.1, 3.2	Specification	5,6
Outline Drawing 1	A70W	7
Outline Drawing 2	A30W	8
Outline Drawing 3	A25S	9
Outline Drawing 4	A10S	10
Outline Drawing 5	A07V	11
Figure 3.1	Performance Curve (A70W, A30W)	12
Figure 3.2	Performance Curve (A25S, A10S)	13
Figure 3.3	Performance Curve (A07V)	14
Figure 3.4	System Flow	15

**Table 3.1 Specification (A70W, A30W)**

Model		A70W	A30W
Pumping Speed (50 / 60Hz)		7000 / 8400 L/min	3000 / 3600 L/min
Ultimate Pressure (50 / 60Hz)		0.27 / 0.13 Pa	0.4 / 0.27 Pa
Connection	Gas Inlet	NW50	
	Gas Outlet	NW40	
Motor		2P 2.2 kW + 3.7 kW	2P 1.5 kW + 2.2 kW
Cooling Water	Connection	Coupler (R c 3/8)	
	Pressure [Gauge Press.]	Supply : Max 0.4 MPa Differential Press. : 0.1 MPa	
	Flow Rate	Min. 3.5 L/min	
	Temperature	Max. 30 deg C	
N <sub>2</sub> Gas	Connection	1/4" Tube Fitting (Same as Swagelok®)	
	Pressure [Gauge Press.]	Supply : 0.1-0.7 MPa Setting : 0.04-0.07 MPa	
	Approx. Flow Rate [Dilution 0 Mode]	24-27 Pa m <sup>3</sup> /s [3.4 Pa m <sup>3</sup> /s]	17-22 Pa m <sup>3</sup> /s [3.4 Pa m <sup>3</sup> /s]
Duct Ventilation	Connection	d50 mm×L50 mm	
	Pressure	-196 Pa	
	Approx. Flow Rate	0.5 m <sup>3</sup> /min	
Lubrication Oil	Brand	FOMBLIN Y-L VAC 25/6 BARRIERTA J100 DEMNUM S-65 KRYTOX VPF 1525	
	Quantity	0.8 L	
Approximate Weight		380 kg	330 kg
Power Supply	Phase/Volt/Freq.	3 Phase, 200V (50 Hz), 200-220 V (60Hz)	
	Current Rating (50 / 60 Hz)	29.5 / 28.1 A	19.7 / 18.5 A
	Connection	MS Series 22-22 (Japan Aviation Electronics Industry)	
Control Signal		57 Series 50 (DDK. Ltd)	

**[Note]** Approximate flow rate of N<sub>2</sub> gas shows a necessary total amount for seal N<sub>2</sub> and dilution N<sub>2</sub>.  
LCD controller displays only the flow rate of dilution N<sub>2</sub>.

**Table 3.2 Specification (A25S, A10S, A07V)**

Model		A25S	A10S	A07V
Pumping Speed (50 / 60 Hz)		2500 / 3000 L/min	1000 / 1200 L/min	700 / 840 L/min
Ultimate Pressure (50 / 60 Hz)		5.3 / 4.0Pa	5.3 / 4.0Pa	1.1 / 1.0 Pa
Connection	Gas Inlet	NW50	NW40	NW40
	Gas Outlet	NW40		
Motor		2P 3.7 kW	2P 2.2 kW	2P 1.5 kW
Cooling Water	Connection	Coupler (R c 3/8)		
	Pressure [Gauge Press.]	Supply : Max . 0.4MPa Differential Press. : Min . 0.1MPa		
	Flow Rate	Min. 3.5 L/min		
	Temperature	Max. 30 deg C		
N <sub>2</sub> Gas	Connection	1/4" Tube Fitting (Same as Swagelok®)		
	Pressure [Gauge Press.]	Supply : 0.1-0.7 MPa [ Setting : 0.04-0.07 MPa ]		
	Approx. Flow Rate**	17-20 Pa m <sup>3</sup> /s [3.4 Pa m <sup>3</sup> /s]	17-20 Pa m <sup>3</sup> /s [3.4 Pa m <sup>3</sup> /s]	15-19 Pa m <sup>3</sup> /s [3.4 Pa m <sup>3</sup> /s]
Duct Ventilation	Connection	d50 mm×L50 mm		d50 mm×L60 mm
	Pressure	-196 Pa		
	Approx. Flow Rate	0.5 m <sup>3</sup> /min		
Lubrication Oil	Brand	FOMBLIN Y-L VAC 25/6 BARRIERTA J100 DEMNUM S-65 KRYTOX VPF 1525		
	Quantity	0.4 L	0.4 L	0.5 L
Approx. Weight		240 kg	220 kg	150 kg
Power Supply	Phase/Volt/Freq.	3 Phase, 200V (50 Hz), 200-220 V (60Hz)		
	Current Rating (50 / 60 Hz)	18.3 / 17.5 A	11.7 / 11.1 A	8.4 / 8.6 A
	Connection	MS Series 22-22	MS Series 20-4	
Control Signal		(Japan Aviation Electronics Industry) 57 Series 50 (DDK. Ltd)		

\*\* Numerals in brackets [ ] are flow rate in dilution-0 mode.

**[Note]** Approximate flow rate of N<sub>2</sub> gas shows a necessary total amount for seal N<sub>2</sub> and dilution N<sub>2</sub>.  
LCD controller displays only the flow rate of dilution N<sub>2</sub>.

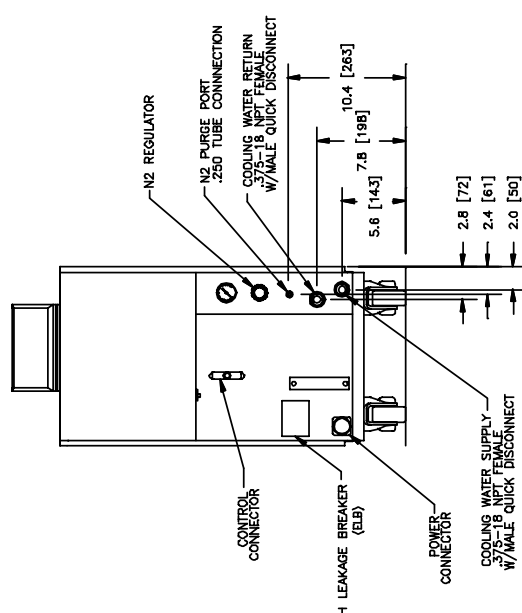
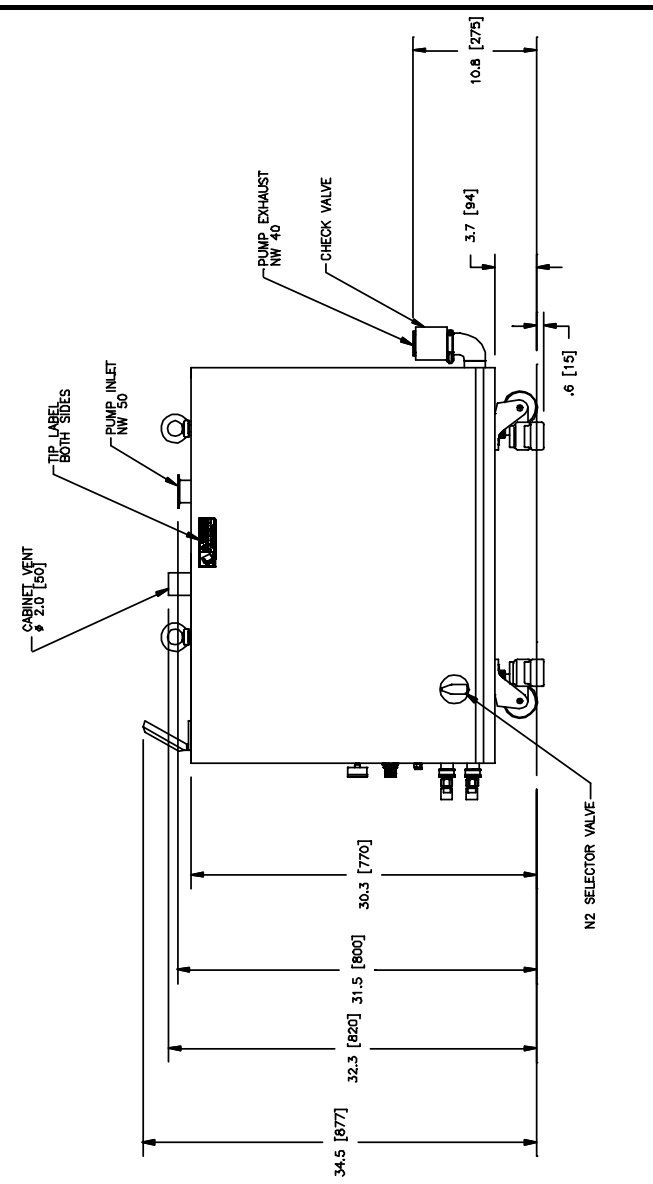
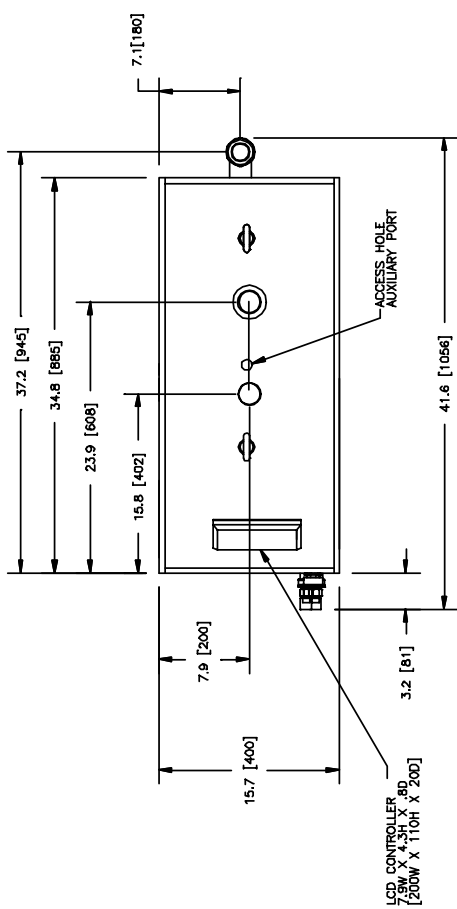

Outline Drawing A70W

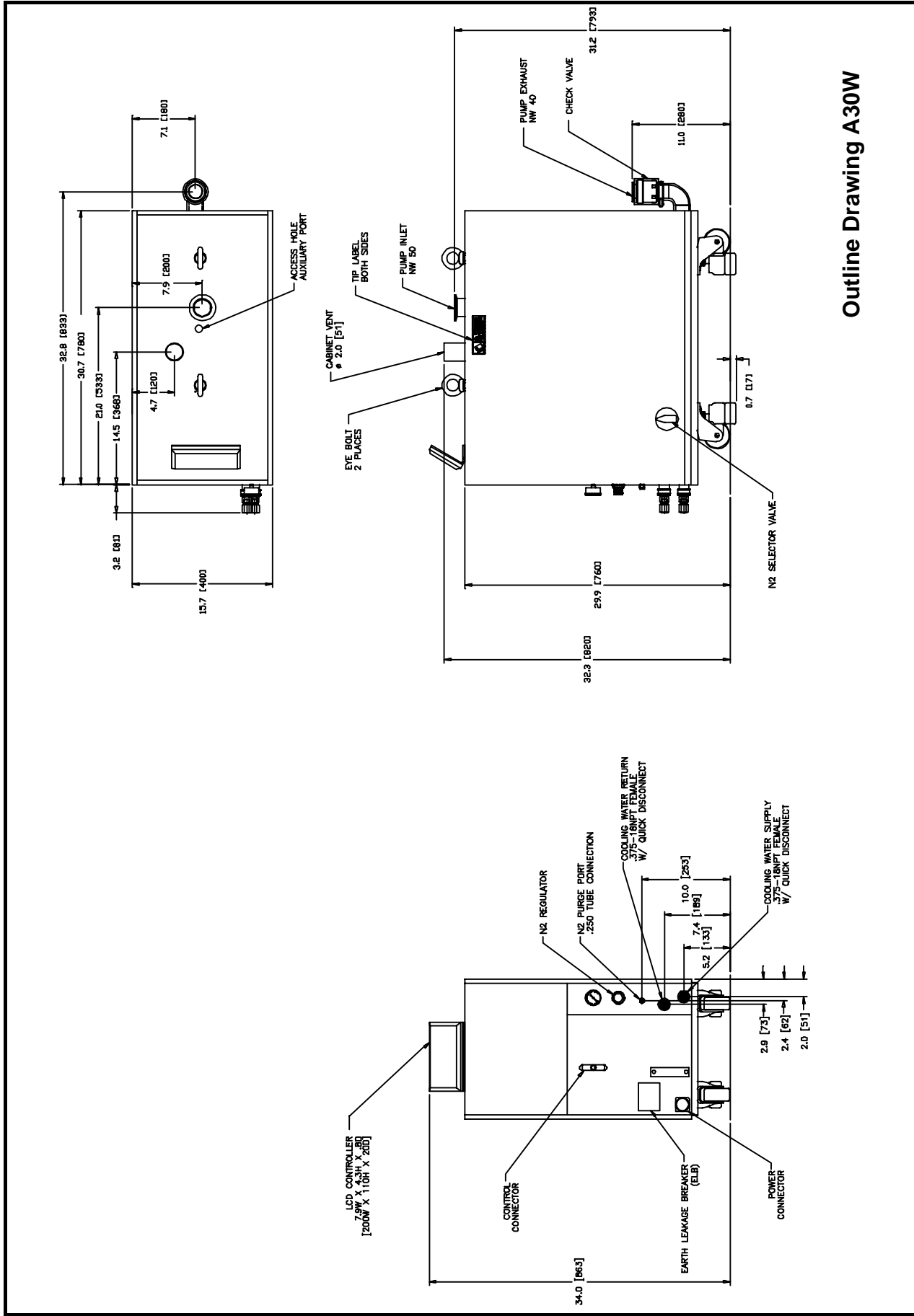

Outline Drawing A30W

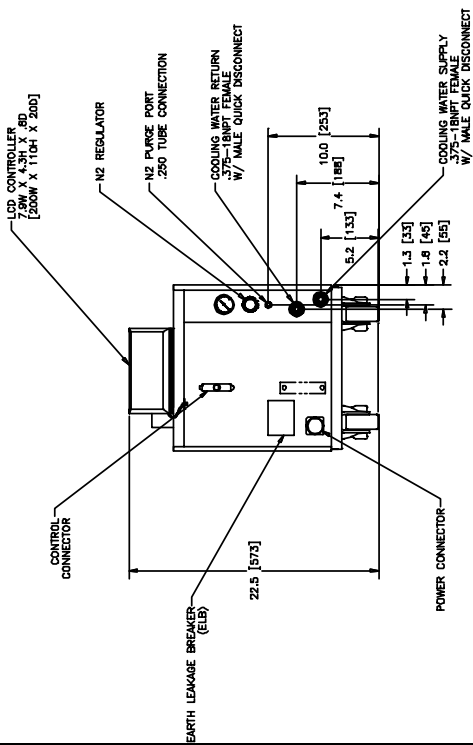
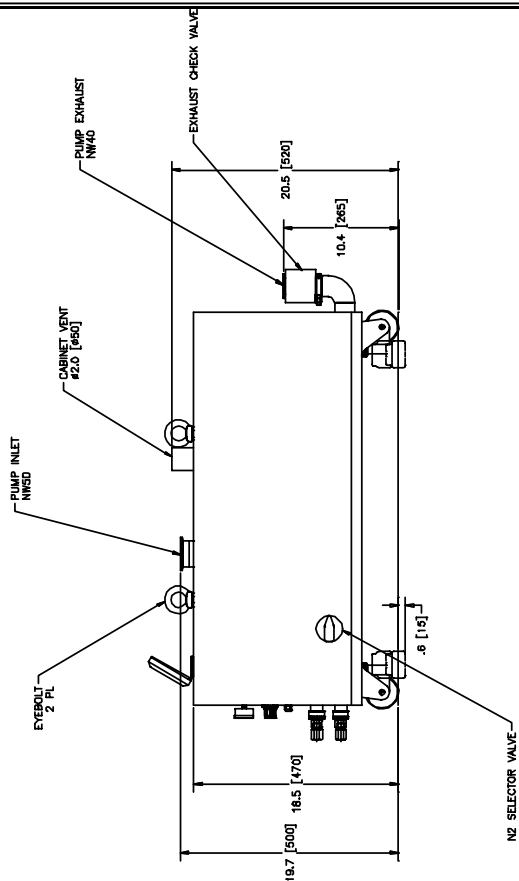
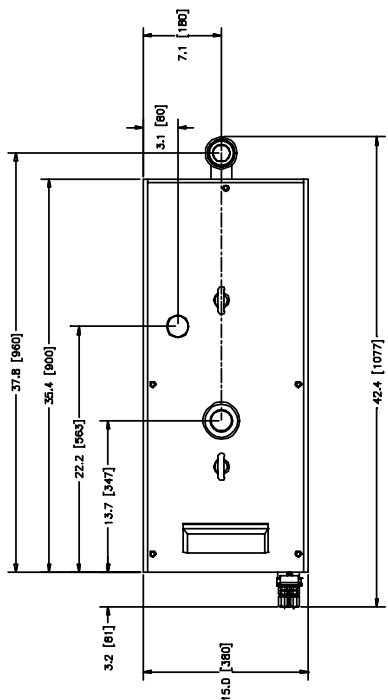

Outline Drawing A25S

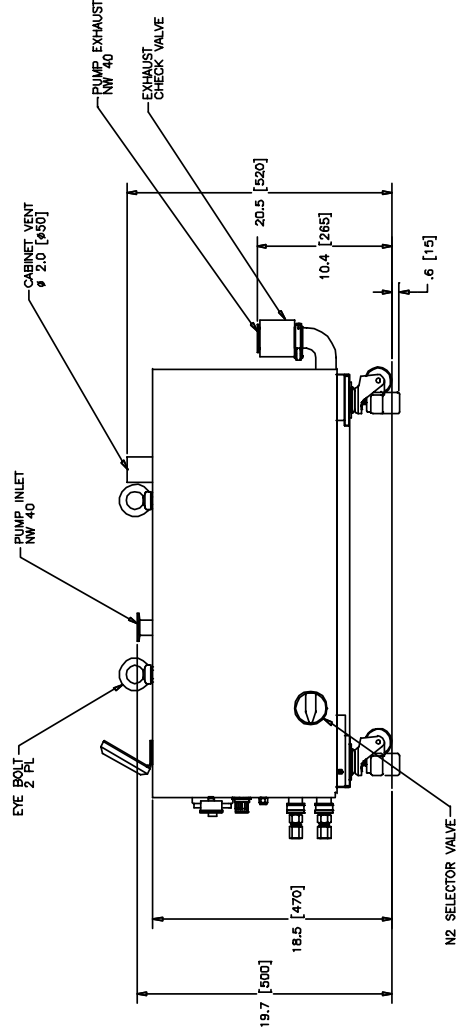
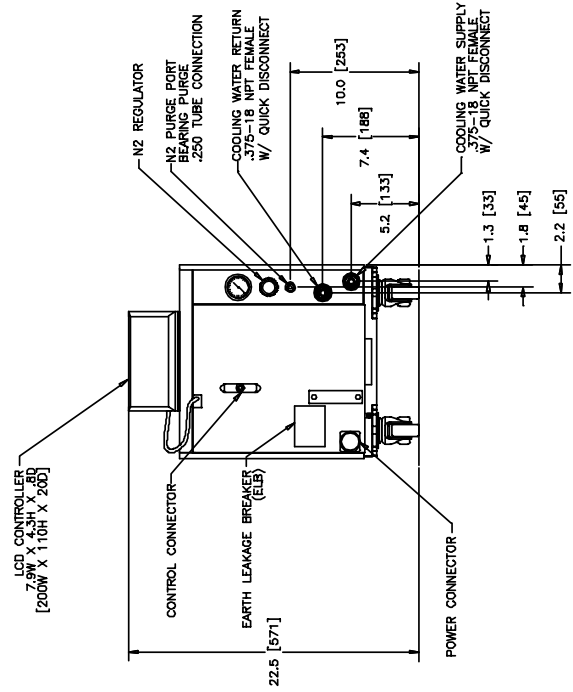
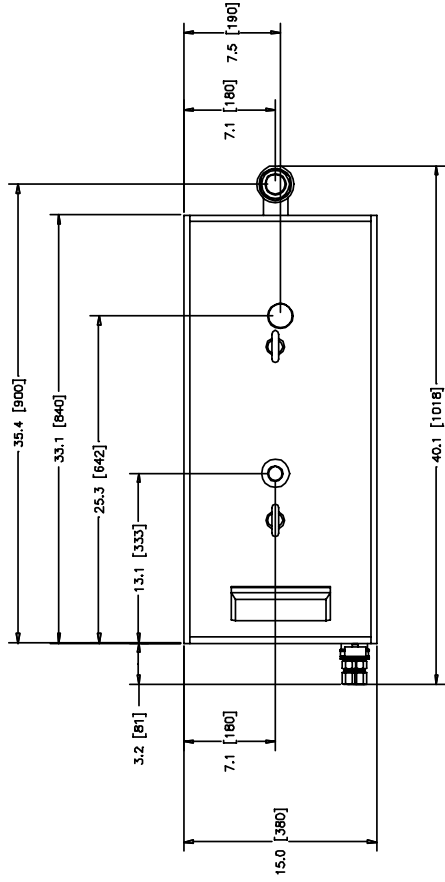

Outline Drawing A10S

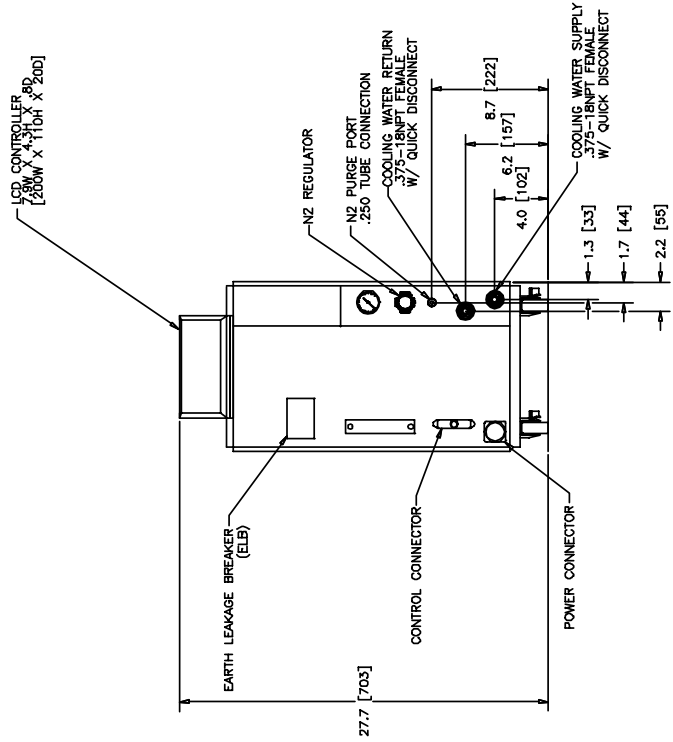
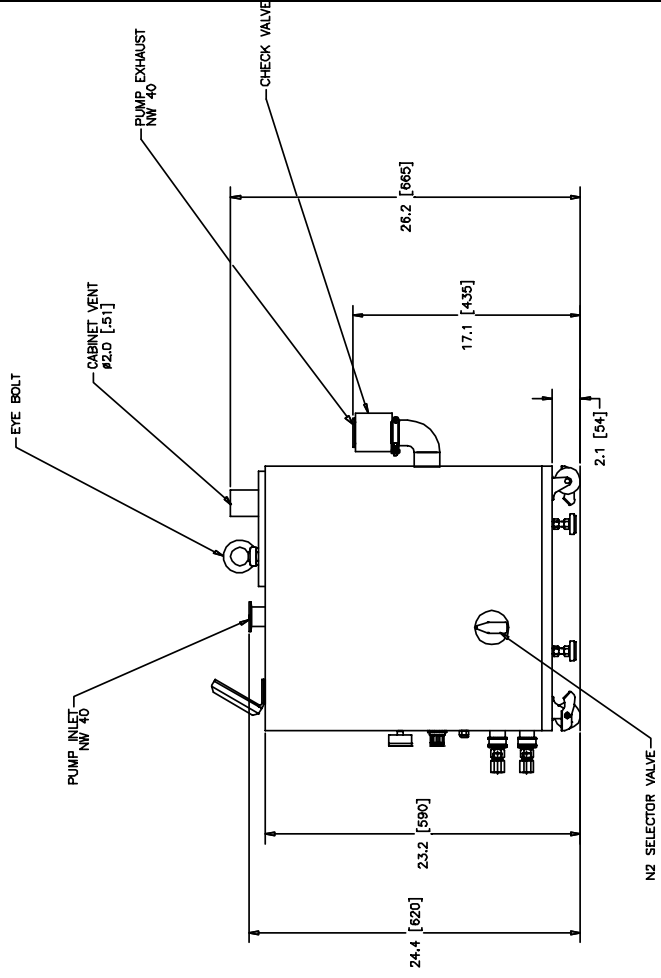
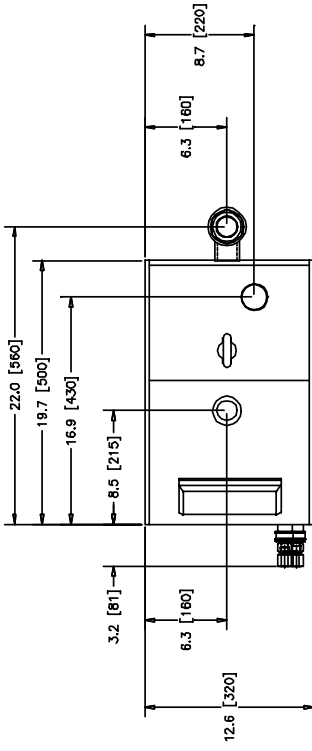

Outline Drawing A07V



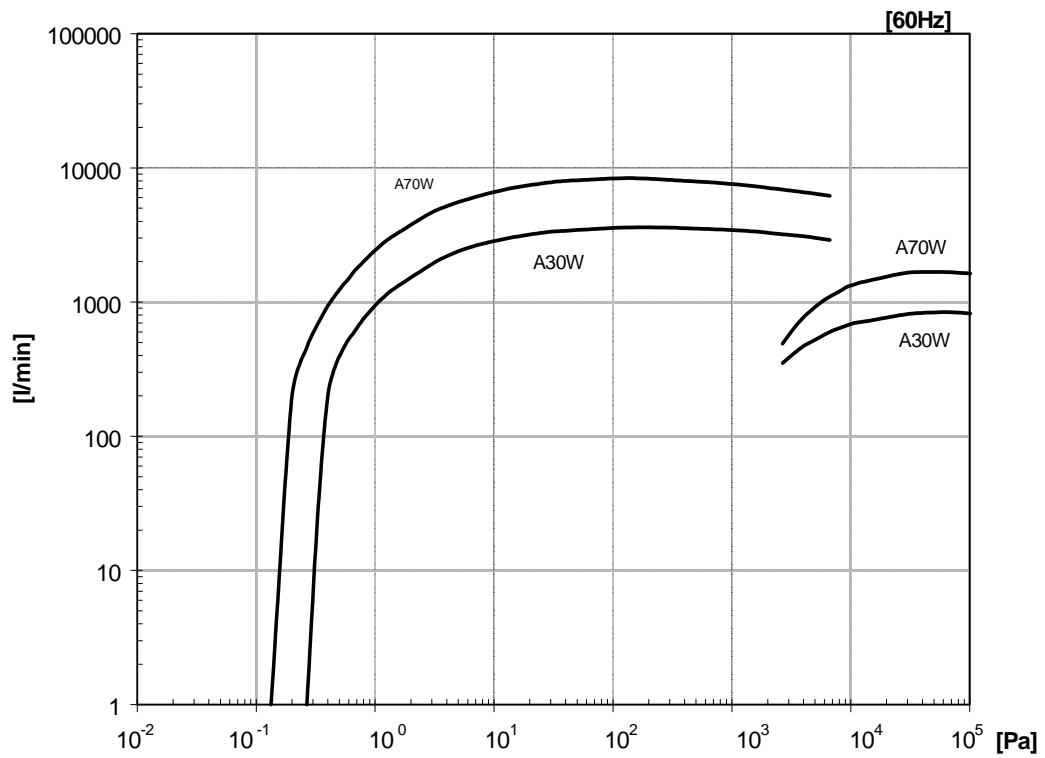
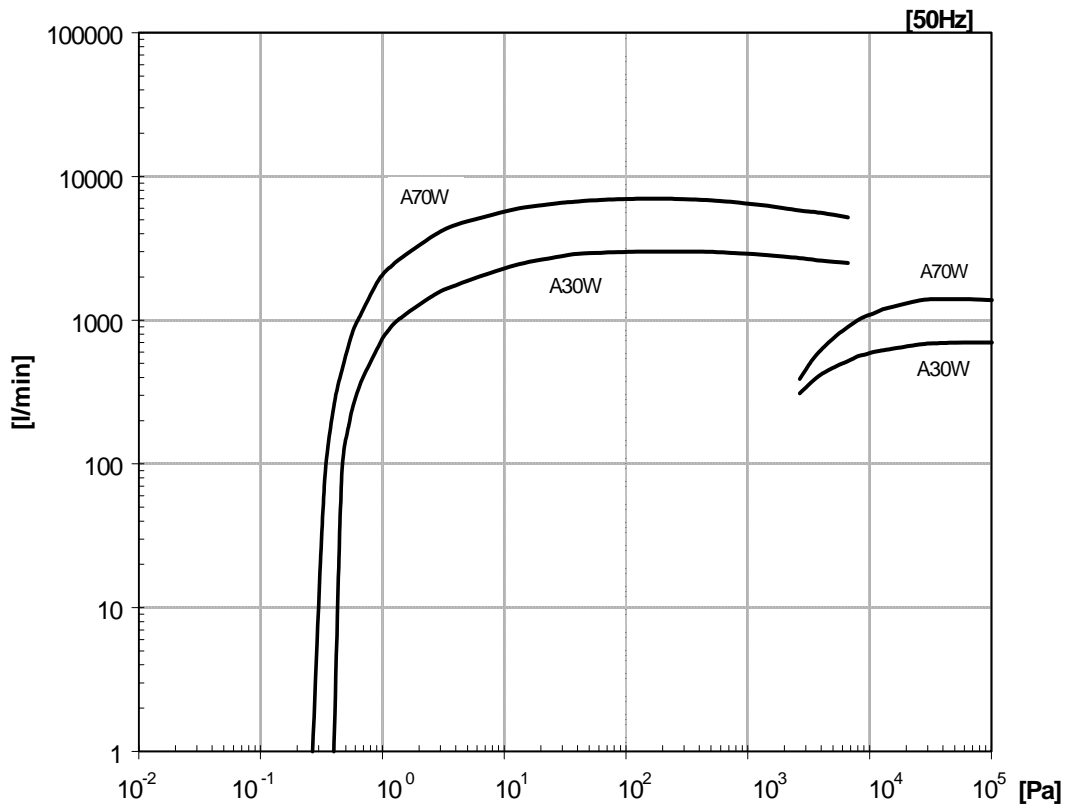

Figure 3.1 Performance Curve (A70W, A30W)

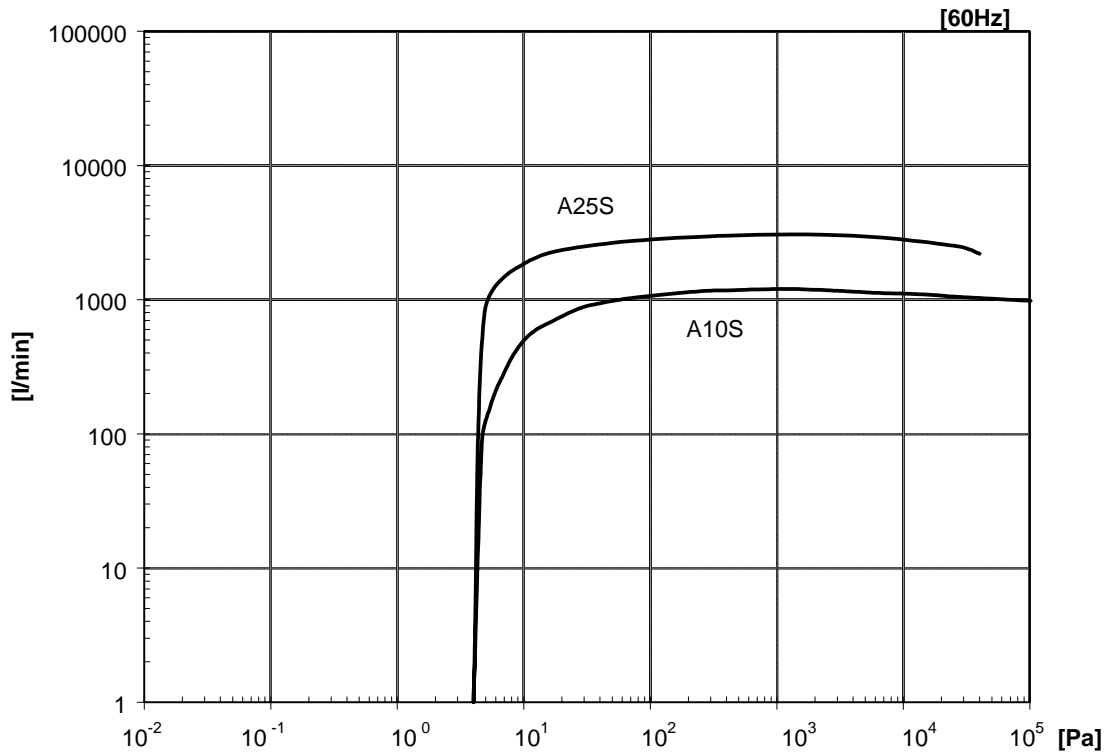
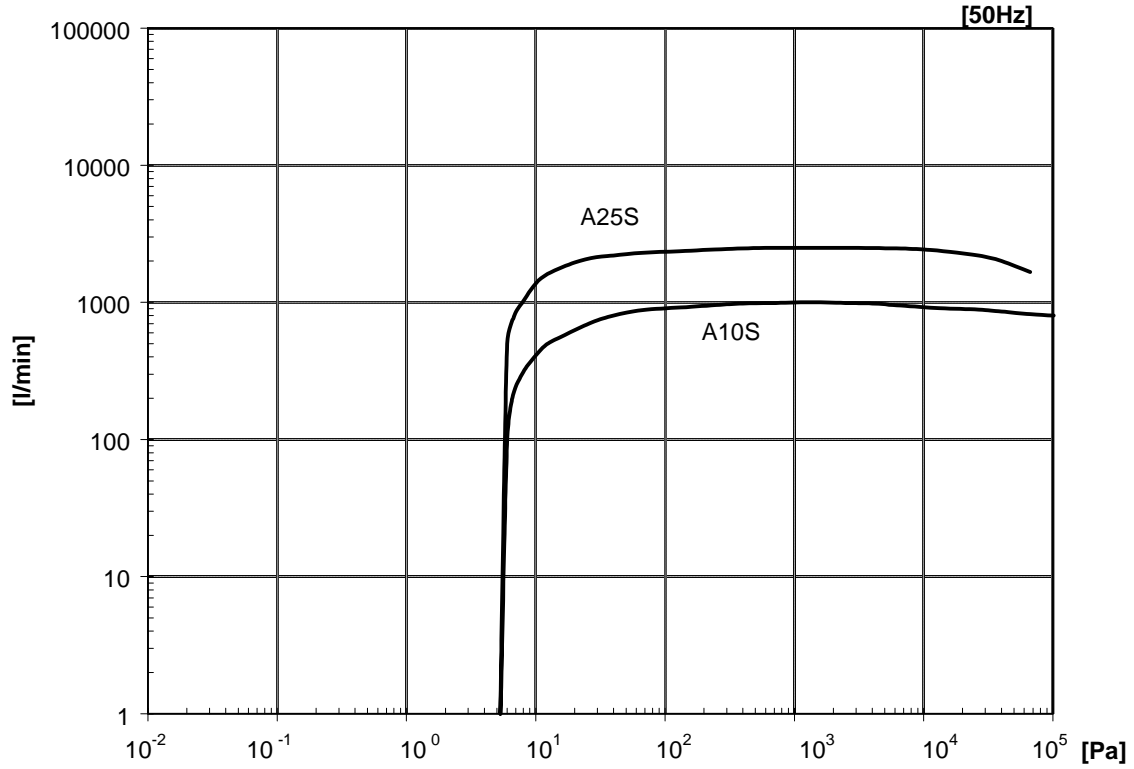

Figure 3.2 Performance Curve (A25S, A10S)

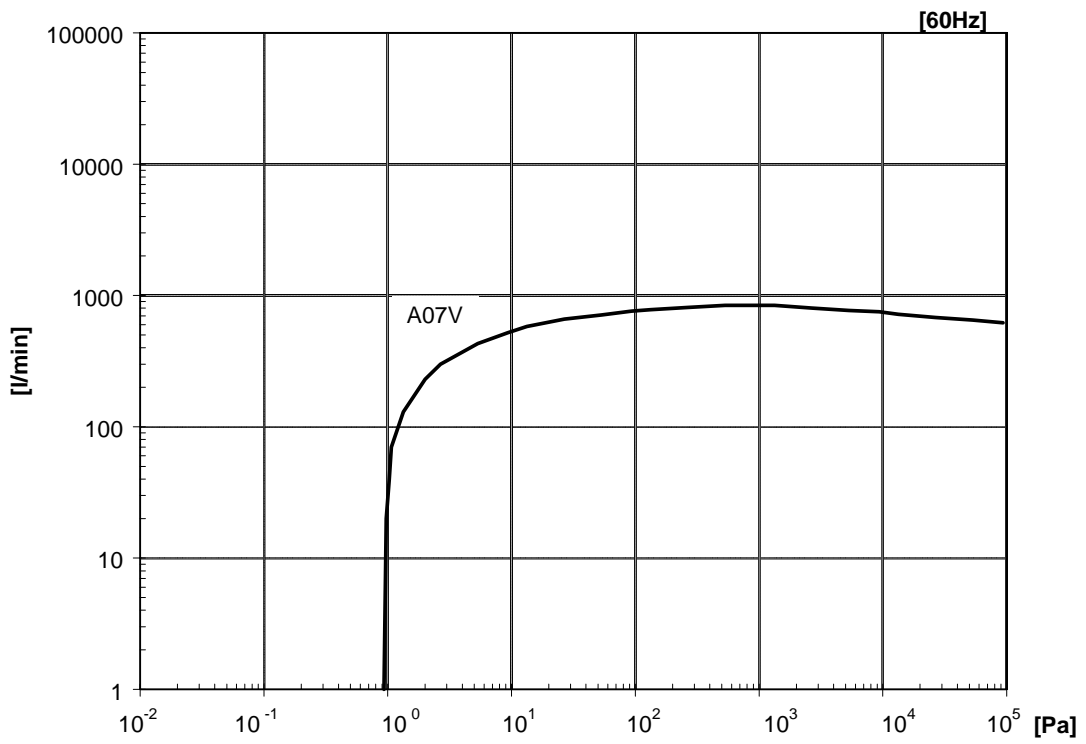
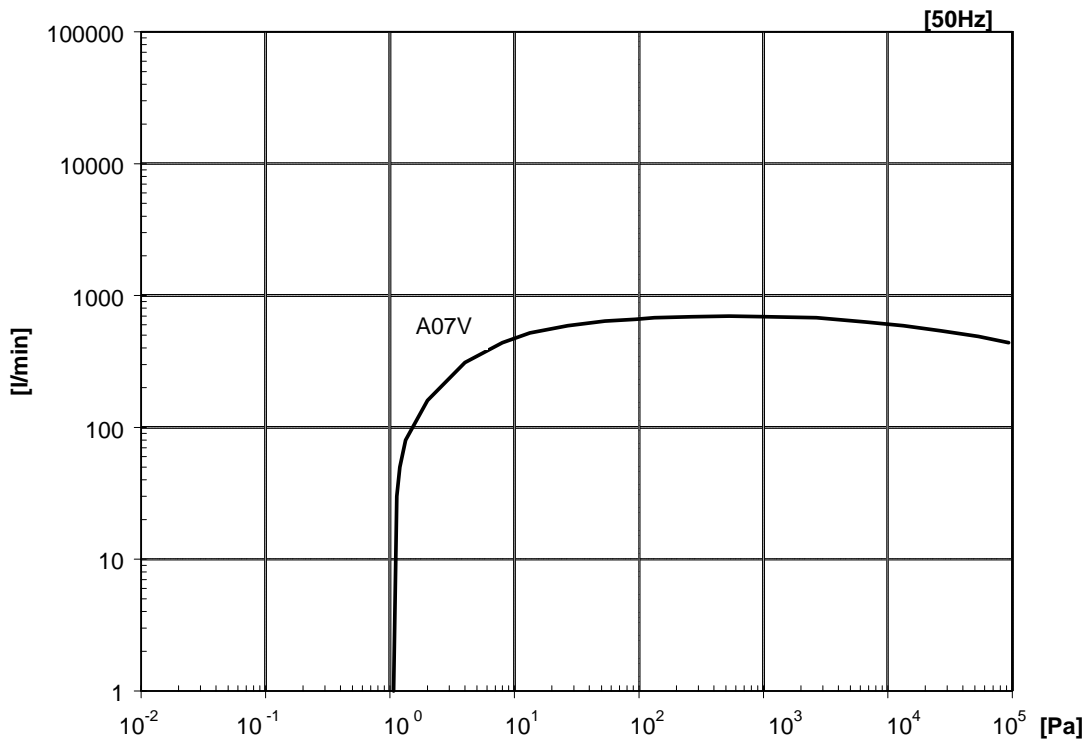
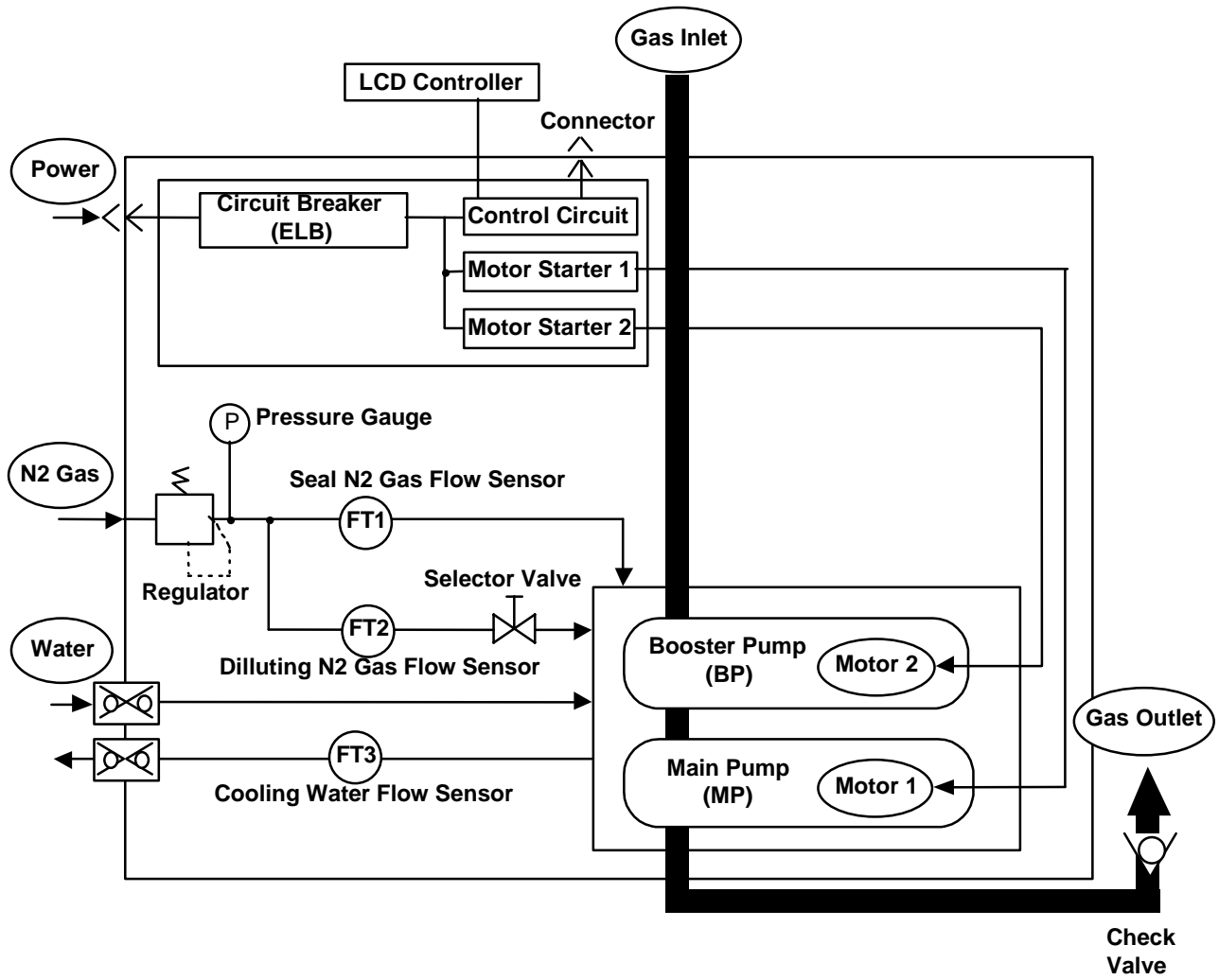

Figure 3.3 Performance Curve (A07V)



[NOTE] A25S, A10S and A07V do not have a booster pump.

Figure 3.4 System Flow

## 4 Installation

Observe the following precautions and instructions when installing the pump.

### 4.1 Location

This pump is suitable for indoor installation. To install the pump, select a place not exposed to dust or humidity and not subject to dew condensation. Also, allow sufficient space to ensure easy pump installation and disassembly for maintenance. If the pump has an interface box, locate it within 3m of the pump.

**! CAUTION** Install pump in a location where ambient temperature does not exceed 30°C. Exercise extra caution when operating the pump in an enclosed room.

**! CAUTION** Leave a gap of at least 50mm between the pump cover and adjacent equipment for ventilation.

Four integral mobile support units, each consisting of a caster and a height-adjustment foot, support the pump base. To move the pump, raise the four adjustment feet by turning the holding nuts in the counterclockwise direction.

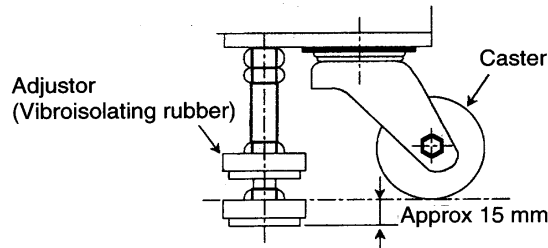

Figure 4.1 Caster

**! WARNING** Be careful not to overturn the pump when pushing or pulling it sideways. The pump is narrow in comparison to its height.

**! CAUTION** The neck portion of the casters will vibrate when the caster is moving. Keep fingers and feet away.

**! CAUTION** Do not step on the pump or place objects upon it.

Turn the holding nuts in the clockwise direction to lower the height-adjustment feet and secure the pump.

Adjust the height of the feet evenly to level the pump base.

The difference in height between the two sides of the pump base shall not exceed 1mm. The adjustment allowance is approximately 15 mm.

**○ [NOTE]** An unlevelled pump may generate an OIL LEVEL LOW ALARM.

**○ [NOTE]** Failure to use adjustment feet will increase floor vibrations.

## 4.2 Piping

### 4.2.1 Vacuum and Exhaust Piping

Connect the vacuum and exhaust pipes to the suction and exhaust flanges respectively. Because of the narrow clearance between pump rotors, ingested foreign objects will prevent the pump from operating. Observe the following cautions when making the flange connections:

- a) Remove all foreign matter from inside the piping.
- b) When connecting flanges, ensure that no dirt or dust particles adhere to the flange surfaces and that the flange surfaces are undamaged.
- c) Prevent the ingestion of wafer fragments and of reaction byproducts that may adhere to the APC valve. For this purpose, a filter or screen may be advisable.
- d) The weight of the pipes attached to the pump can cause misalignment and leaks from the flange connections. Support the piping properly and do not apply excessive force to align flange faces.
- e) EBARA recommends the insertion of a flexible bellows between the piping and the suction and exhaust flanges of the pump.
- f) Length of the flexible bellows on the suction side will vary according to the vacuum drawn. Connect without applying undue force to the flexible bellows.



#### **DANGER**

Check for leaks after installing the pump. A leak may lead to the dangerous discharge of hazardous substances or to unpredictable reactions with air admitted into the pump.

### 4.2.2 Cooling Water Piping

Connect the cooling water pipes to the correct inlet and outlet ports.

The water ports are quick-connect couplers. Seat the plug firmly in the socket. The socket sleeve will return to the front (Figure 4.2).

Do not connect the supply/return plugs in reverse. The diameters are slightly different, and there are In/Out markings on the plugs.

Disconnection automatically blocks water flow.

Use cooling water corresponding to the specifications of Table 4.1.

**Table 4.1 Industrial Water Supply Quality Specifications**

(Japan Industrial Water Association, Industrial Water Quality Standards Committee)

Turbidity	(ppm)	20
pH		6.5-8.0
Alkalinity(CaCO <sub>3</sub> )	(ppm)	75
Hardness(CaCO <sub>3</sub> )	(ppm)	120
Evaporation residue	(ppm)	250
Chlorine ion	(ppm)	80
Iron	(ppm)	0.3
Manganese	(ppm)	0.2

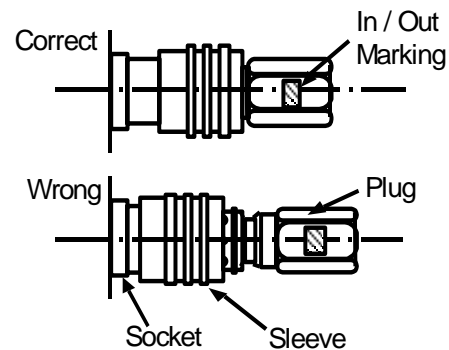
**Figure 4.2 Coupler****DANGER**

When disconnecting water, first close the supply valve and then remove the supply coupler.

When connecting, insert the return coupler first.

Connecting or disconnecting in the wrong order may cause a rapid pressure rise—leading to a water leak.

**CAUTION**

Even if the cooling water flow rate drops, the pump will continue to operate until the casing temperature reaches the TRIP limit.

Select facility water piping rated for at least 70°C at the operating pressure.

**CAUTION**

Do not connect pump cooling water loops in series. Select piping to ensure sufficient flow through each pump.

**CAUTION**

Connect supply and return couplers correctly to avoid reverse flow. Reverse flow will read incorrectly on the LCD, will not cool the pump properly, and may lead to an accident.

**CAUTION**

In humid locations, allowing the cooling water to run when the pump is stopped will lead to condensation on parts of the pump. If droplets appear on the outside of the water tubes when the pump is not running, cut off water flow.

### 4.2.3 N<sub>2</sub> Gas Piping

Cut tube at right angles and make the end-face perfectly smooth. Then connect the tube to the tube fitting assembly of the N<sub>2</sub> gas purge port. The tube will push fit onto the shoulder of the tube fitting assembly.

Secure the tube fitting assembly properly and tighten the retaining nut by hand. Then use a tool to tighten the nut an additional 1 ¼ turns.

To reconnect the tube again after subsequent removal, install the tube already fitted to the ferrule and retighten the retaining nut slightly (about ¼ turn) beyond hand tight.

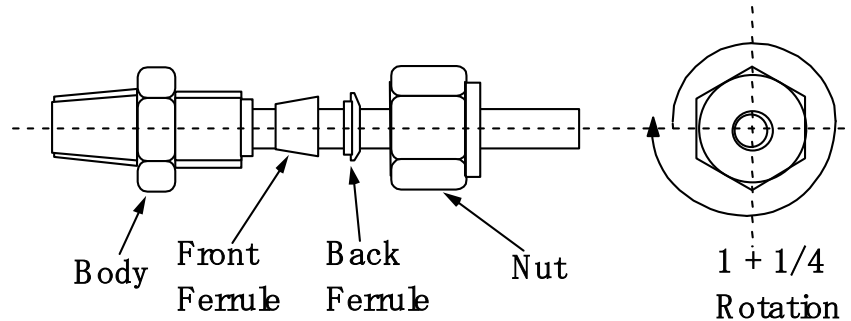

**Figure 4.3 Tube Fitting Assembly**

### 4.2.4 Ventilation Duct

Exhaust hot air from the pump enclosure through the ventilating duct port in the top cover. Without proper ventilation, the temperature inside the cover may rise, causing an ALARM.

The pump does not have a gas leak detector. For hazardous gases, EBARA recommends installing a gas leak detector, interlocked to gas flow, in the ventilation duct piping.

Use an exhaust duct material that resists corrosion from the gas(es) pumped.



#### CAUTION

For safety, ventilate through the enclosure exhaust duct when the pump application is toxic and/or flammable gases. Do not combine the ventilation duct with the pump exhaust piping.



#### [NOTE]

Even when pumping process gases that are not toxic or flammable, do not combine the ventilation duct with the pump exhaust piping. The exhaust noise of the pump may cause acoustic resonance inside the pump unit and result in abnormal noise.



### 4.3 Electrical Wiring



#### WARNING

Keep the power supply to the pump turned off and locked out until you have finished the wiring and connecting work. Interrupt the Earth Leakage Breaker (ELB) or circuit breaker (CB).

#### 4.3.1 Power Supply Wiring



#### CAUTION

Ensure that the grounding wire is connected. Connect this product to a grounded, metallic, permanent wiring system.



#### CAUTION

Match the wiring size and material to the power consumption and ambient air temperature of the pump.



#### CAUTION

Use the threaded-coupling power connector provided with the pump. At the power source size connect direct to distribution panel wiring terminals or use a twist-lock, Hubbel-type connector.

Wire the connector for the main power supply (200V AC at 3-phase and 50Hz, 200-220V AC at 3-phase and 60Hz). See figure and tables below for connector pin assignments and specifications.

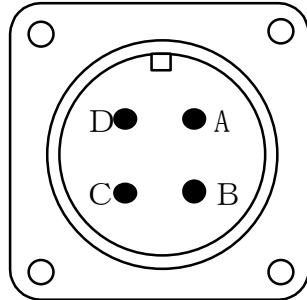

**Figure 4.4 Power Supply Receptacle**

(As seen from connecting side)

**Table 4.2 Pin Assignments**

**Power Supply Receptacle**

No.	Phase
A	R
B	S
C	T
D	Ground

**Table 4.3 Receptacle Specifications**

Pump Model	A70W	A30W	A25S	A10S	A07V
Receptacle manufacturer	Japan Aviation Electronics Industry Co., Ltd.				
Receptacle type	MS3102A 22-22P			MS3102A 20-4P	
Current A (50/60 Hz)	29.5 / 28.1	19.7 / 18.5	18.3 / 17.5	11.7 / 18.5	8.4 / 8.6
Adapted plug type	MS3106B 22-22S			MS3106B 20-4S	
Suitable wire	AWG #8 - #10			AWG #12 - #14	

### 4.3.2 Control Signal Wiring

Connect wires to the control connector for remote operation and remote monitoring. Tables 4.4 and 4.5 and Figures 4.5 and 4.6 show the pin assignments.

**Table 4.4 Receptacle Specifications**  
(Identical for all types)

Receptacle type	57FE-40500
Receptacle manufacturer	DDK. Ltd.
Adapted plug type	57-30500
Suitable wire size	AWG #24
Applied voltage for input *1	12V DC 20 mA
Contact capacity of output *2	50V DC/Maximum. 50 mA

- \*1. Apply voltage through pump.  
\*2. Apply voltage through equipment.

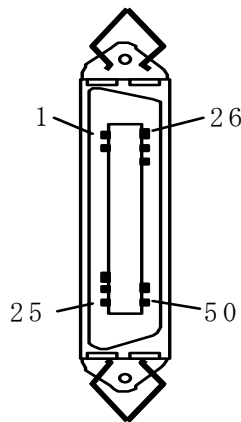

**Figure 4.5 Control Signal Receptacle**  
(As seen from connecting side)

**CAUTION**

Do not wire vacant pins.

**CAUTION**

Apply 12V DC power for input signals on the pump side. Do not apply this voltage on the equipment side.

The output signals are generated from an open collector output. Apply a voltage not exceeding 50V DC on the equipment side.

**CAUTION**

Wire all signals with the correct polarity (SIGNAL/COMMON).

**CAUTION**

When output signals energize an inductive load, such as a relay, insert a diode (100V, 1A class) to absorb the back electromotive force from surge currents.

### 1. Input signal

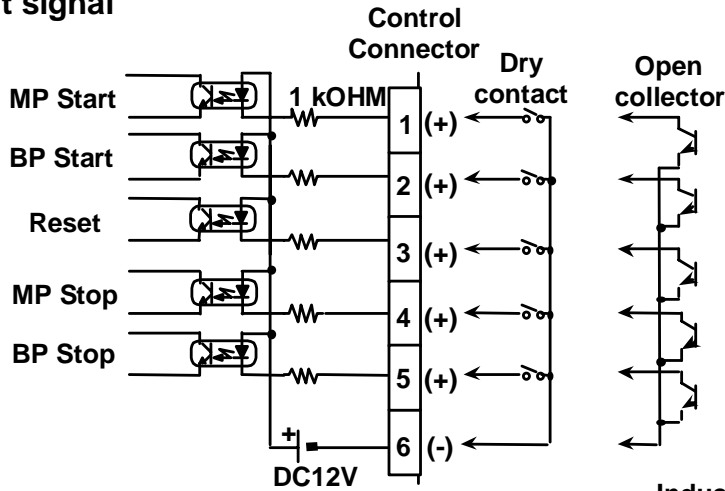

### 2. Output Signal

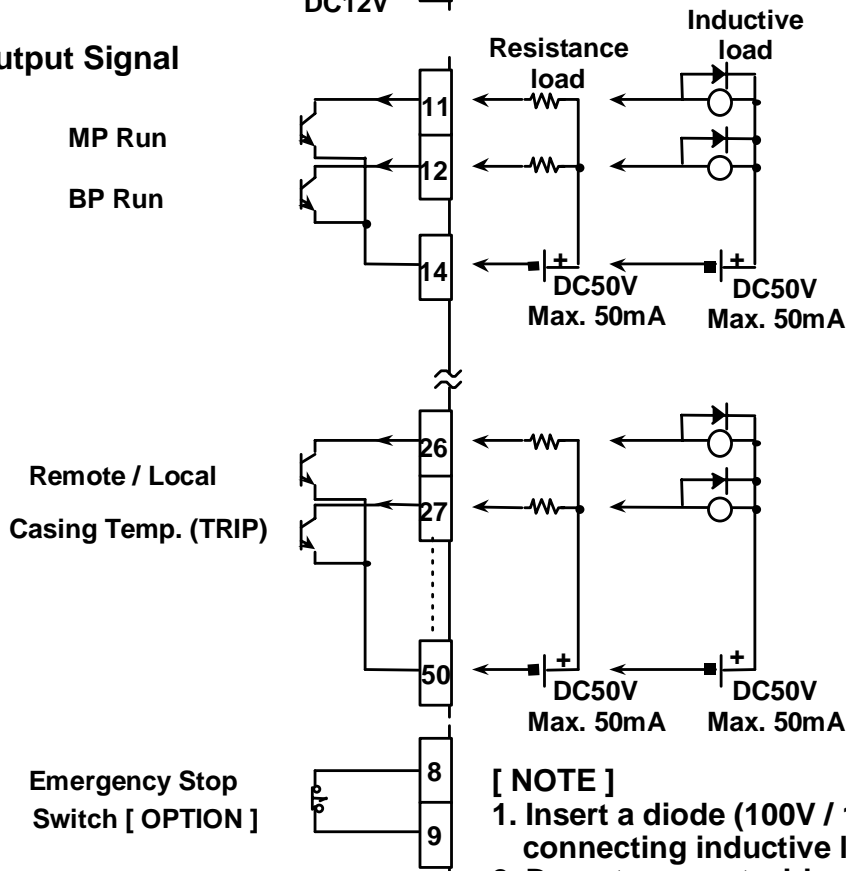

Figure 4.6 Control Signal Wiring

**Table 4.5 Pin Assignment (Do not connect wires to unassigned pins.)**

No	Signal name	I/O	Signal type	No	Signal name	I/O	Signal type
1	MP start	IN	N.O., Alternate *1	26	REMOTE/LOCAL	OUT	N.O., Alternate
2	BP start *6	IN	N.O., Alternate *1	27	Casing Temp. (TRIP)	OUT	N.O., Alternate
3	ALARM/TRIP Reset	IN	N.O., Momentary *2	28	MP Motor Temp. (TRIP)	OUT	N.O., Alternate
4	MP Stop	IN	N.O., Momentary *1	29	BP Motor Temp. (TRIP) *6	OUT	N.O., Alternate
5	BP Stop *6	IN	N.O., Momentary *1	30	MP Overload (TRIP)	OUT	N.O., Alternate
6	COM of 1-5	IN		31	BP Overload (TRIP) *6	OUT	N.O., Alternate
7				32	Phase Error (TRIP)	OUT	N.O., Alternate
8	Emergency Stop *3	OUT	N.C., Alternate	33			
9	COM of 8	OUT		34	Water Leak (TRIP) *3	OUT	N.O., Alternate
10				35	Exhaust Press. (TRIP) *3	OUT	N.O., Alternate
11	MP Operation	OUT	N.O., Alternate	36			
12	BP Operation *6	OUT	N.O., Alternate	37	Water Flow (ALARM) *4	OUT	N.O., Alternate
13				38	Sealing N <sub>2</sub> Flow (ALARM) *4	OUT	N.O., Alternate
14	COM of 11-12	OUT		39	Dilut. N <sub>2</sub> Flow (ALARM) *4 *5	OUT	N.O., Alternate
15				40	Casing Temp. (ALARM)	OUT	N.O., Alternate
16				41	MP Current (ALARM)	OUT	N.O., Alternate
17				42	BP Current (ALARM) *6	OUT	N.O., Alternate
18				43	Oil Level (ALARM)	OUT	N.O., Alternate
19	TRIP/Collective	OUT	N.C., Alternate	44			
20	COM of 19	OUT		45	Bearing Temp. (ALARM) *6	OUT	N.O., Alternate
21				46			
22	ALARM/Collective	OUT	N.C., Alternate	47			
23	COM of 22	OUT		48			
24				49			
25				50	COM of 26-45	OUT	

MP = Main Pump, BP = Booster Pump.

Models A25S, A10S, A07V do not have a BP.

**[NOTE]**

- \*1 Dipswitch No. 5 selects external start / stop signal type.  
Off : Alternate signal (Use only Pins 1 and 2.)  
On : Pulse signal (Use Pins 1 and 2 for start and Pins 4 and 5 for stop,  
Change Pins 1 and 2 to momentary signals with Dipswitch No. 5.)  
In remote mode, select pump operation “according to signal” or “automatically stop” with Dipswitch No.4.  
Use Dipswitch No.8 to configure remote BP operation as “automatic” or “according to signal.”
- \*2 Input signal duration for Pin No. 3 (ALARM / TRIP Reset) and Pins No. 1, 2, 4, and 5 (Momentary Start / Stop) is 200ms.
- \*3 Pins No. 8 (Emergency Stop Switch), 34 (Water Leakage), and 35 (Exhaust Pressure) are for options. Pin No. 8 (Emergency Stop Switch) output remains OFF until the switch is closed and a RESET signal is entered.
- \*4 Dipswitch No.2 selects observation of cooling water and N<sub>2</sub> gas flow as “always” or “operating period only.”

- \*5 When Dipswitch No. 7 is OFF (Normal Mode), a decrease in dilution N<sub>2</sub> flow will cause an output on Pin No. 39. When Dipswitch No. 7 is ON (Dilution 0 Mode), this same output on Pin 39 indicates that the dilution N<sub>2</sub> selector valve is open.
- \*6 Pins No. 2 (BP Start), 5 (BP Stop), 12 (BP Operation), 29 (BP Motor Temp.), 31 (BP Overload), 42 (BP Current) apply to Models A70W and A30W. Only Model A07V uses Pin No. 45 (Bearing Temperature).

**CAUTION**

Do not wire vacant pins.

**CAUTION**

Apply 12V DC power for input signals on the pump side. Do not apply this voltage on the equipment side.

The output signals are generated from an open collector output. Apply a voltage not exceeding 50V DC on the equipment side.

**CAUTION**

Wire all signals with the correct polarity (SIGNAL/COMMON).

**CAUTION**

When output signals energize an inductive load, such as a relay, insert a diode (100V, 1A class) to absorb the back electromotive force from surge currents.

#### 4.4 Operation Mode

Set the dipswitches on the control panel in accordance with the conditions (Table 4.6).

**Table 4.6 Dipswitch Settings**

No.	Mode	Off	On
1	RS232C Data Length	7bit	8bit
2	Service observation	Always	Operating period only
3	Buzzer	Not used	Used
4	Operation switched to remote	According to signal	Automatically stop
5	Remote start signal	Alternating	Momentary (Pulse)
6	-----	-----	-----
7	Dilution N <sub>2</sub>	With dilution	Without dilution
8	BP operation	Automatic	According to signal

When using the RS232C communication port to monitor pump status, select a Data Length of either 7 bits or 8 bits.

Dipswitch No. 2 configures observation of cooling water and N<sub>2</sub> gas flow as either "always" or "operating period only." Even when "operating period only" is selected, observation of cooling water flow continues for 15 minutes after pump stops.

Dipswitch No. 3 selects Buzzer usage in ALARM / TRIP condition.

In remote mode, select pump operation "according to signal" or "automatically stop" with Dipswitch No.4.

Dipswitch No. 5 sets configuration for remote START / STOP signals as either "alternate (maintained) signal" or "pulse (momentary) signal."

Pins 1, 2, 4, and 5 pins become momentary signal ports when Dipswitch No. 5 is ON.

Dipswitch No. 7 sets dilution N<sub>2</sub> usage.

For applications that neither deposit byproducts nor corrode the pump (e.g. load lock, sputtering, SEM) the user may reduce nitrogen consumption by closing the dilution N<sub>2</sub> selector valve located on the side of the pump and turning on Dipswitch No. 7,

In dilution mode, the pump outputs a Dilution N<sub>2</sub> Flow ALARM when dilution N<sub>2</sub> flow decreases; in zero dilution mode, the pump outputs a Dilution N<sub>2</sub> Flow ALARM when dilution N<sub>2</sub> selector valve is open.

**[NOTE]** Select compatible settings for the dilution N<sub>2</sub> selector valve and Dipswitch No. 7 together.

Set Dipswitch No. 8 ON to start and stop BP automatically based on inlet vacuum; set Dipswitch No. 8 OFF to start and stop BP with a remote signal.

**[NOTE]** The user may toggle remote / local switch and use of the buzzer at any time. The pump stores the setting of other switches at start up. Turn power OFF to change the settings.

Default factory settings at time of shipment are: Data Length = 8 bits, always observation, buzzer in use, according to signal, alternating signal, with dilution mode, BP automatic operation, and Local operation. Refer to Figure 4.7.

**Figure 4.7 Switch Settings**

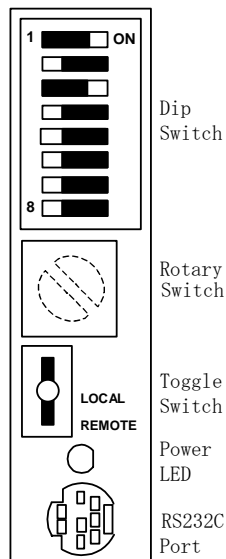

## 5 Operation

 **WARNING** Following an Emergency Stop or TRIP (auto shut down), troubleshoot the pump as described in Section 8 before restarting.

 **[NOTE]** These pumps are factory filled with lubrication oil.

### 5.1 Before Starting

Turn on the cooling water flow and check piping for water leaks.

 **CAUTION** Without sufficient cooling water, the pump temperature will rise, which may cause rotor contact or other problems.

**[NOTE]** The pump unit has no cooling water valve.

Turn on the N<sub>2</sub> gas supply.

Check that the regulator attached to the pump is closed, i.e. the pressure adjustment knob is fully counterclockwise. Open the main valve and check that there are no N<sub>2</sub> gas leaks from the pipe connections.

Slowly turn the pressure adjustment knob clockwise to set the pressure (gauge pressure) to 0.05 MPa. Then press the red stopper to lock the knob in position.

 **WARNING** Supply N<sub>2</sub> gas to the exhaust piping when it is necessary to dilute flammable or toxic gases down to safe concentration.

 **CAUTION** Set N<sub>2</sub> flow rate appropriately to avoid problems such as oil carryover, corrosion inside the pump and deposition of byproducts.

Operate dilution N<sub>2</sub> selector valve, located on the side face of pump cover, in accord with the dilution N<sub>2</sub> mode setting of dipswitch.

<b>Dipswitch No. 7</b>	ON	OFF
<b>Selector Valve</b>	CLOSED	OPEN

 **[NOTE]** N<sub>2</sub> gas flow requires several seconds to stabilize after opening valve.

 **[NOTE]** During regular operation, open dilution N<sub>2</sub> gas selector valve except for processes that are non-corrosive and do not produce reaction byproducts.

Turn on power.

Turn on the ELB and ensure that the yellow LED (beside the dipswitches) lights. The LCD controller counts down 10 seconds. Refer to Table 5.2 and Figure 5.1.

**[NOTE]** After turning on power, the instruments warm up for 10 seconds before the pump will start.

Ensure cooling water flow is 3.5 L/min or more.

Readjust regulator so that dilution N<sub>2</sub> gas is within the range described below.

**Table 5.1 Dilution N<sub>2</sub> gas flow**

A70W	20-24 Pa m <sup>3</sup> /s
A30W	15-19 Pa m <sup>3</sup> /s
A25S	14-17 Pa m <sup>3</sup> /s
A10S	14-17 Pa m <sup>3</sup> /s
A07V	12-15 Pa m <sup>3</sup> /s

Then ensure that pressure gauge indicates 0.04-0.07 MPa.

After setting, push the red stopper of knob to lock.

Under this condition, shaft seal N<sub>2</sub> flow rate is 2.7-3.4 Pa m<sup>3</sup>/s. (Shaft seal N<sub>2</sub> flow rate is not shown on LCD.)

Check that LCD displays no ALARM/TRIP signal.

The motor current is indicated as "00.0 A" on LCD.

When LCD indicates an ALARM/TRIP signal or an abnormal symptom appears, take necessary measures in accordance with Section 8.

**[NOTE]** ALARM/TRIP signal persists until entry of a RESET signal even if the causes are remedied.

After taking necessary measures, either press the RESET switch on the LCD controller or input RESET signal through the control connector.

When buzzer is in use, pressing BUZZER OFF mutes the buzzer despite an ALARM/TRIP condition.

Open the valve on the exhaust piping before starting the pump.

If the system has an exhaust gas scrubber, open its inlet and outlet valves.



**CAUTION**

Operating pump with these valves closed will pressurize the exhaust and overload the pump.



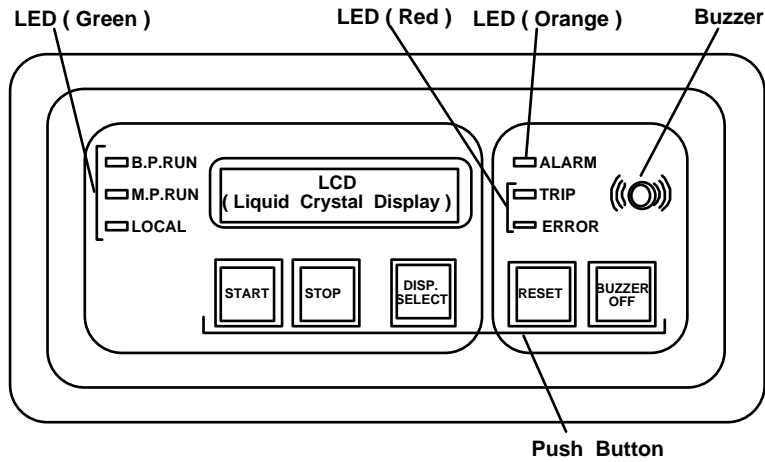

**Figure 5.1 LCD Controller**

[Buttons]	START :	Start MP and BP
	STOP :	Start of MP and BP
	DISP. SELECT :	Change LCD indication
	RESET :	Reset ALARM and TRIP
	BUZZER OFF :	Mute buzzer in ALARM / TRIP
[LED]	B.P. RUN :	BP running
	M.P. RUN :	MP running
	LOCAL :	LOCAL mode
	ALARM :	ALARM condition
	TRIP :	TRIP condition
	ERROR :	Microprocessor malfunction

Table 5.2 LCD Controller Indication

No	ITEM	INDICATION
1.1	Operating mode selection 1 (10 second count down)	& & & & & & % UTY:STD REM:SIG @
1.2	Operating mode selection 2 (10 sec count down)	& & & & & & RUN:ALT % DIL:STD BP:AT @
2	Motor current	BP: ##.# A % MP: ##.# A
3	Cooling water flow	W A T E R F L O W % ##.# L/m i n
4	Dilution N <sub>2</sub> gas flow (with dilution mode)	DIL.N2 FLOW % ##.# P a m 3 / s
5	Dilution N <sub>2</sub> gas flow (without dilution mode)	W/O DIL.N2 MODE %
6	Pump casing temperature	PUMP CASING % ### * C
7	Total operation time	OPE.TIME % ##### h
8	ALARM / TRIP	\$\$\$\$\$:\$\$\$\$\$\$\$ % \$\$\$\$\$\$\$\$\$\$\$\$\$\$\$\$

" &&&&&& " shows pump serial number.

" % " shows present number of ALARM / TRIP.

" @ " shows 10 second countdown after turning on power.

Mode selection contains items below.

UTY : Service observation      REM : Operation switched to remote  
 RUN : Remote start signal      DIL : Dilution N<sub>2</sub>  
 BP : BP operation

Dilution N<sub>2</sub> gas flow displays the amount of N<sub>2</sub> gas excluding seal N<sub>2</sub>; therefore, it differs from the N<sub>2</sub> approximate flow rate in Table 3.1.

Total operation time displays the hours of operation after initialization at factory.

Upper row "\$\$\$\$\$\$" describes cause of ALARM / TRIP.

Lower row "\$\$\$\$\$\$" shows value of parameter that caused ALARM / TRIP.

Display defaults to No. 2 (Motor Current) when buttons on LCD controller are not operated for one minute.

"DISP. SELECT" scrolls the display in order. It will display progressively all present ALARM/TRIP's.

## 5.2 Operation

REMOTE / LOCAL and USE OF BUZZER can be toggled at any time. Select properly according to the working conditions.

If Dipswitch No. 4 is ON, pump automatically stops when changed to remote mode.



**WARNING**

The pump casing and exhaust piping become extremely hot during operation and for some time after stopping.

Keep pump and exhaust piping away from contact with personnel and flammable substances.

Do not remove the pump cover during operation.



**CAUTION**

When the production process leads to reaction byproducts in the pump or when the process handles corrosive gases, do not stop the pump until after at least 30 minutes after stopping the flow of process gases.



**WARNING**

Purge with N<sub>2</sub> gas for one (1) hour or more after the pump stops to remove the residual process gas inside the pump.



**CAUTION**

The pump will remain at a very high temperature even after it has stopped. Leave the cooling water running for about one (1) hour after shutdown.

Shutting off cooling water immediately after the pump stops causes a pressure rise in the cooling water piping, which may cause a water leak.



**[NOTE]**

Do not pump process gases until the pump has run at least one hour. If possible, wait four hours for the pump casing temperature to stabilize before pumping process gases.



**[NOTE]**

In service observation mode “Always,” cooling water and dilution N<sub>2</sub> ALARMS can occur when the pump is stopped.



**[NOTE]**

The pump will not start while an ALARM/TRIP signal remains active. Pressing START button will bring STARTFAIL to the display.

---

### 5.2.1 Local (Pump side) Operation

#### Start

Press controller START button.

MP (Main Pump) starts and MP RUN LED lights.

BP (Booster Pump) starts automatically, and BP RUN LED lights.

While pump is running, the default LCD display is motor current(s).

For other indications of pump condition, refer to Table 5.2.



**[NOTE]** The pump will not start while an ALARM/TRIP signal remains active. Pressing START button will bring STARTFAIL to the display.

#### Stop

Press controller STOP button.

Both MP and BP stop and both RUN LED go out.

Motor current is indicated as "00.0 A."

### 5.2.2 Remote (Distant) Operation

#### Start

**[NOTE]** External signal type must comply with dipswitch settings.

Input external MP START signal from control connector.

MP starts.

In BP automatic operation mode, BP starts and stops automatically based on the pump inlet vacuum.

When operating BP by remote signal, input external BP START signal from control connector only when inlet pressure is less than or equal to 4000 Pa.

#### Stop

[Alternating signal mode]

Turn MP START signal off, both MP and BP stop.

[Momentary (Pulse) signal mode]

Input external MP STOP signal, both MP and BP stop.

## 6 Maintenance and Overhaul

### 6.1 Routine Inspection

Check periodically that there is no ALARM signal on the LCD controller or remote output. Any ALARM indicates that the pump is operating in abnormal condition.

**Table 6.1 Typical Check Items**

No.	Item	Sensor	Interval(recommended)
1	Motor Current	CT	1 time/week
2	N <sub>2</sub> Gas Flow	Flow sensor	
3	Vibration / Noise	-----	
4	Lubrication oil Quantity	Level switch	
5	Cooling water flow	Flow sensor	
6	Pump casing Temp.	T/C	
7	Color of lubrication oil	-----	1 time/month

If any ALARM/TRIP occurs, take necessary measures according to Section 8.



#### WARNING

Switch off the power supply to the pump; interrupt the ELB or CB and lockout power before you start maintenance.



#### WARNING

The pump and exhaust piping will remain at a high temperature during operation and for a short time after the pump has stopped.

Avoid contact and keep flammable substances out of reach.

Do not remove the outer cover during operation.



#### [NOTE]

Even after clearing the cause of the ALARM/TRIP signal, the display will persist until the RESET signal is entered. After you have taken the remedial action, press the RESET button on the controller or enter the RESET signal from the control signal connector to reset the ALARM/TRIP status.



#### CAUTION

An ALARM signal will not stop the pump.

However, continuing pump operation in this condition may lead to a TRIP signal or a serious breakdown. After completion of the next wafer cycle, check the pump in accordance with the instructions of Section 8.



#### CAUTION

In the REMOTE operating mode, when a TRIP signal has occurred, interrupt the external start signal before beginning maintenance. If the external ALTERNATE start signal is present, the pump will start as soon as the TRIP is RESET.

## 6.2 Piping Maintenance

**WARNING**

Purge system with sufficient N<sub>2</sub> gas before removing and cleaning the vacuum lines and exhaust piping.

Prevent dispersal of flammable, toxic or dangerous materials and guard against their contact with the human body.

Work only in locations with an emergency escape route.

**WARNING**

Check for gas leaks after installing and maintaining the piping.

Gas leaks will result in the discharge of harmful and dangerous substances and in abnormal reactions due to the admission of air into the pump

**CAUTION**

Dispose of process byproducts in strict accord with all local and national environmental and safety regulations.

Follow the instructions below when carrying out maintenance work on the vacuum and exhaust piping of the pump.

Before you remove and wash the piping, purge with a sufficient volume of N<sub>2</sub> gas.

On systems with an exhaust gas scrubber, interrupt N<sub>2</sub> purge and close the inlet valve of the scrubber before removing the piping.

Switch off the power supply.

After cleaning the piping, do not reconnect until it has dried completely.

## 6.3 Lubricant Oil

**CAUTION**

Do not start filling oil until the pump interior reaches atmospheric pressure. During pump operation, the chamber containing the oil is under vacuum. Removing the oil fill plug while the pump is running will cause oil carryover and damage the pump.

**CAUTION**

A licensed industrial waste disposal dealer should dispose of waste oil in accordance with Material Safety Data Sheet (Appendix 1).

Upon an OIL LEVEL LOW ALARM or whenever the lubricant oil needs replenishing, fill the oil chamber and drain the oil that has collected in the secondary reservoir.

## 6.4 Spare (Maintenance) Parts List

Pump maintenance requires the following parts at customer site.

**Table 6.2**

### 1. Standard Consumable

Item	Type	EC Part No.	ETI Part No.
PFPE oil	FOMBLIN Y-L VAC 25/6 BARRIERTA J100 DEMNUM S-65 KRYTOX VPF 1525	CER01-4002	927009

### 2. Parts Recommended for Safe Operation

Item	Type	EC Part No.	ETI Part No.
O-ring (Viton A)	NW25	CER01-4746	980928
	NW40	CER01-4747	980927
	G55 (For exhaust check valve)	CER01-4402-2	923111

### 3. Parts Recommended for Quick Maintenance

Item	Type	EC Part No.	ETI Part No.
Exhaust check valve	32X80L	CER01-4402	980083

### 4. Recommended Spare Parts (not needed for each pump)

Item	Type	EC Part No.	ETI Part No.
Oil level switch	NOR. CLOSE	CER90-6515	-----
Water flow sensor	20 L/min	CER90-6018	942020
Pump gas flow sensor (seal)	3.4 Pam <sup>3</sup> /s	CER90-6012	
N <sub>2</sub> flow sensor	84.4 Pam <sup>3</sup> /s	CER90-6017	-----
T/C bolt	T TYPE, M8	CER90-6035	913046
N <sub>2</sub> gas pressure regulator	R31-200-C121	CER01-4420	980086

(EC: EBARA CORPORATION; ETI: EBARA TECHNOLOGIES INCORPORATED)

The pump enclosure panels carry the following labels. If a label should peel off or become illegible, replace it as directed in the Warning Label Drawings.

**Table 6.3 Labels**

<b>Label Name</b>	<b>EC Part No.</b>	<b>ETI Part No.</b>
[DANGER] HAZARDOUS WEIGHT DANGER	CER90-9193	322237
[WARNING] HAZARDOUS VOLTAGE WARNING	CER90-9115	321868
[WARNING] HIGH TEMPERATURE WARNING	CER90-9113	321866
[WARNING] HAZARDOUS MATERIAL WARNING	CER90-9116	321869
[CAUTION] CHARGE MARK	CER90-9112	321865

## **6.5 Overhaul**

Properly trained personnel should perform overhaul work. Contact EBARA sales office or overhaul service center.



## 7 Removal and Transportation



**WARNING**

When a pump exhausts highly toxic gases such as arsenic and mercury compounds, contact EBARA Corporation before you return the pump.



**CAUTION**

In the interest of safety during the transportation, disassembly and cleaning of the pump, take note of the gases that it has pumped.



**[NOTE]**

In the U.S., Department of Transportation regulations may apply to the shipment of your pump. See Appendix 5.

To disconnect and transport the pump, proceed as follows.

Stop the pump and replace all gases inside the pump by purging them with N<sub>2</sub> gas.

Switch off the power supply to the pump; remove the power and signal wires.

After fully closing the N<sub>2</sub> regulator and removing the N<sub>2</sub> pipe, seal off the N<sub>2</sub> purge port with a sealing flange.

Remove the cooling water pipes.

Remove the vacuum and exhaust pipes and completely seal off the suction and exhaust ports of the pump with a blind flange or similar seal. Seal off other process gas connection points, such as the differential port, with a blind flange.

Tape the LCD controller, face down, to the pump's top cover.

Wrap the pump in a vinyl sheet.

Use the eyebolts provided on the pump for slinging the pump to load and unload. Fasten eyebolts completely; turn in until flush with the seating surface. For sling, use a wire with a length so that the slinging angle (that is, the angled subtended by the two wires) is 60° or less.

**[NOTE]:** A07V has only one eyebolt.



**DANGER**

Do not enter the zone underneath the suspended pump.



**WARNING**

Only qualified personnel should lift the pump.

Ensure that the wire rope and crane used for lifting the pump are in proper order and match the weight of the pump.

To prevent unequal weight distribution, suspend the pump with symmetrically centered slinging angle.



**CAUTION**

To avoid oil leaks when lifting or transporting the pump, do not keep it more than 10° off the horizontal longer than five minutes.

---

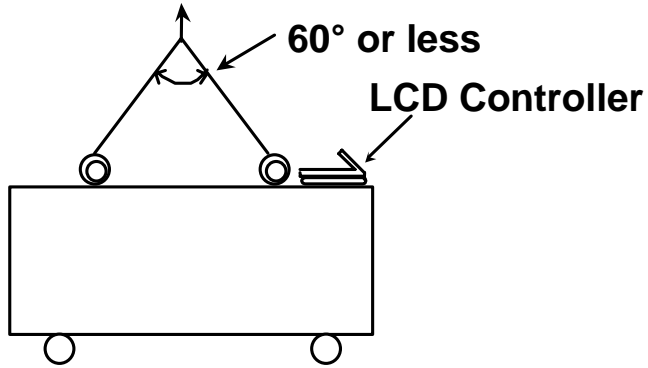

**Figure 7.1**

Route the sling to avoid damaging any options, such as an interface box, mounted on the pump.

To transport an uncrated pump, lower the adjustment feet. Place a protective cloth around the pump and use protective members between the outer cover and the tie down straps to distribute the strap load.

## 8 Troubleshooting

### 8.1 Troubleshooting (1) Basic Trouble

Abnormal symptom	Check Item	Corrective Action
Circuit breaker is activated. (Leakage detector is on.)	Incorrect wiring	Check wiring
	Ground fault	Replace or overhaul pump
	Short circuit	Replace or overhaul pump
Power LED does not come on.	No power supply to pump	Check power supply
	Connector is not connected	Connect power connector
	ELB is not mode ON	Switch ELB ON
Nothing appears on LCD. Display is abnormal.	ELB is not mode ON	Switch ELB ON
	Instruments are in failure	Replace instruments
MP does not start when pressing START button.	Mode is set in "Remote"	Set switch to "Local" mode
	Start-up conditions are not satisfied ("STARTFAIL" is displayed)	Satisfy all start-up conditions
	Instruments are in failure	Replace instruments
MP does not start when applying START signal.	Mode is set in "Local"	Set switch to "Remote" mode
	Mode is set in "Alternate" (Pump jogs)	Apply "Alternate" start signal Set to "Momentary" mode
	Instruments are in failure	Replace instruments
BP does not start.	Leakage on vacuum piping	Check piping
	MP insufficient vacuum	Replace or overhaul
	BP start signal is not applied	Apply BP start signal
	Instrument failure	Replace instruments
Abnormal noise. Excessive vibration.	Adjuster foot is not lowered	Properly set all adjuster feet
	Cover is in contact with other items	Remove objects from cover
	Cover screws loose	Tighten mounting screws
	Pump part is damaged	Replace or overhaul pump
Vacuum pressure increase.	Byproducts settled in piping	Clean up piping
	N <sub>2</sub> pressure setting is high	Set pressure for correct value
	Leakage from vacuum piping	Check piping
	Byproducts settled in pump	Replace or overhaul pump



#### WARNING

Interrupt Earth Leakage Breaker (ELB) or CB and lock out power before starting on wiring and maintenance work.

Do not switch on the power supply to the pump until work is completed.



#### WARNING

The pump casing and exhaust piping become extremely hot during operation and for some time after stopping.

Keep pump and exhaust piping away from contact with personnel and flammable substances.

Do not remove the pump cover during operation.



#### WARNING

Check for gas leaks after installing and maintaining the piping.

Gas leaks will result in the discharge of harmful and dangerous substances and in abnormal reactions due to the admission of air into the pump

## 8.2 Troubleshooting (2) ALARM

Display	Symptom	Check Item	Corrective Action
ALARM: WATER FLOW LOW ###.#	Water flow decreases.	Coupler is disconnected	Connect coupler
		Pressure is not sufficient	Apply sufficient pressure
		Source valve is closed	Open valve
		Water piping is clogged	Clean or replace piping
		Water piping leaks	Check the fittings
		Instruments are in failure	Replace instruments
		Inlet/Outlet is reverse (Flow rate 0L/min)	Connect correctly
ALARM: SEAL N2 FLOW LOW  ALARM: DIL. N2 FLOW LOW ###.# [w/ dilution mode]  ALARM: DIL. N2. VALVE OPEN [w/o dilution mode]	Shaft seal. N <sub>2</sub> flow decreases.	N <sub>2</sub> port is not connected	Connect N <sub>2</sub> pipe fitting
		Primary pressure is insufficient	Apply sufficient pressure
		Regulator setting low	Increase pressure setting
	Dilution N <sub>2</sub> . flow decreases. *1 [w/ dilution mode]	N <sub>2</sub> piping is clogged	Replace N <sub>2</sub> piping
		N <sub>2</sub> piping leaks	Check the fittings
		Instruments are in failure	Replace instruments
	Dilution N <sub>2</sub> valve open. *2 [w/o dilution mode]	Selector valve is closed *1	Open the valve Set to zero dilution mode"
		Selector valve is open *2	Close the valve Set to "standard mode"
	ALARM: BP MOTOR CURRENT HIGH###.#  ALARM: MP MOTOR CURRENT HIGH###.#	BP motor current rises.	Exhaust pressure rises
Rotor is in contact (Byproducts) (Substance plunge) (Cooling water decrease) (Gear or bearing damage)			Replace or overhaul pump Replace or overhaul pump Increase water slowly Replace or overhaul pump
MP motor current rises.		Instruments are in failure	Replace instruments
		Power supply failure	Check power supply
		Exhaust pressure rise	Check exhaust piping
ALARM: CASING TEMP HIGH ###.#	Casing temperature rises.	Duct ventilation is insufficient	Ventilate sufficiently
		Byproduct is clogged	Replace or overhaul pump
		Cooling water decrease	Increase water slowly
		Decrease of oil	Fill the lubricating oil
ALARM: BP-GEAR OIL LEVEL LOW  ALARM: BP-MOTOR	BP gear side oil level low	Insufficient sealing N <sub>2</sub>	Check sealing N <sub>2</sub> ALARM
		Pump is inclined	Level the pump with adjuster feet
	BP motor side oil		

Display	Symptom	Check Item	Corrective Action
OIL LEVEL LOW	level low	Instruments are in failure	Replace instruments
ALARM: MP-GEAR OIL LEVEL LOW	MP gear side oil level low		
ALARM: MP-MOTOR OIL LEVEL LOW	MP motor side oil level low		
ALARM: OIL LEVEL LOW	Oil level low in oil pan. [A07V only]		
ALARM: DRV BRG TEMP HIGH	Driving shaft brg temp. rises. [A07V]	Cooling water decrease	Increase water slowly
ALARM: DRVN BRG TEMP HIGH	Driven shaft brg temp. rises. [A07V]	Decrease of grease	Change the grease
		Bearing is damaged	Replace or overhaul pump
ALARM: PUMP BOX TEMP HIGH	Temperature in pump cover rises.	Duct ventilation not sufficient	Ventilate sufficiently
		Cooling water decrease	Increase water

After taking corrective action, input RESET signal or push RESET button. The pump will not RESET while the cause of the ALARM remains.

**WARNING**

Interrupt Earth Leakage Breaker (ELB) or CB and lock out power before starting on wiring and maintenance work.  
Do not switch on the power supply to the pump until work is completed.

**WARNING**

The pump casing and exhaust piping become extremely hot during operation and for some time after stopping.  
Keep pump and exhaust piping away from contact with personnel and flammable substances.

Do not remove the pump cover during operation.

**WARNING**

Check for gas leaks after installing and maintaining the piping.

Gas leaks will result in the discharge of harmful and dangerous substances and in abnormal reactions due to the admission of air into the pump

### 8.3 Troubleshooting (3) TRIP

Display	Symptom	Check Item	Corrective Action
TRIP: CASING TEMP H.HIGH	Pump casing temp. rises.	Exhaust pressure rise	Check exhaust piping
		Cooling water decrease	Increase water slowly
		Byproduct clog	Replace or overhaul pump
		Duct ventilation insufficient	Ventilate sufficiently
TRIP: BP MOTOR TEMP HIGH TRIP: MP MOTOR TEMP HIGH	BP motor temp. rises. MP motor temp. rises.	Cooling water decrease	Increase water slowly
		Motor is in failure	Replace or overhaul pump
TRIP: BP MOTOR OVERLOAD  TRIP: MP MOTOR OVERLOAD	BP current rises. (thermal relay trip)  MP current rises. (thermal relay trip)	Exhaust pressure rise	Check exhaust piping
		Byproduct clog	Replace or overhaul pump
TRIP: PHASE ERROR	Negative phase  Open phase	Object ingestion	Replace or overhaul pump
		Instruments are in failure	Replace instruments
		Power supply failure	Check power supply
TRIP: PHASE ERROR	Negative phase  Open phase	Incorrect wiring	Wire R/S/T/E correctly
		Instruments are in failure	Replace instruments
TRIP: BP MOTOR NO CURRENT TRIP: MP MOTOR NO CURRENT	BP motor current value is 0. MP motor current value is 0.	Incorrect wiring	Check power supply
		Instruments are in failure	Replace instruments
TRIP: STARTFAIL ALARM/TRIP EXIST	Start fault	Starting in ALARM / TRIP condition	Satisfy all starting conditions
		Instruments are in failure	Replace instruments

After taking corrective action, input RESET signal or push RESET button. The pump will not RESET while the cause of the TRIP remains. In remote operation mode, interrupt external START signal before resetting.



#### WARNING

Interrupt Earth Leakage Breaker (ELB) or CB and lock out power before starting on wiring and maintenance work.

Do not switch on the power supply to the pump until work is completed.



#### WARNING

The pump casing and exhaust piping become extremely hot during operation and for some time after stopping.

Keep pump and exhaust piping away from contact with personnel and flammable substances.

Do not remove the pump cover during operation.



#### WARNING

Check for gas leaks after installing and maintaining the piping.

Gas leaks will result in the discharge of harmful and dangerous substances and in abnormal reactions due to the admission of air into the pump.

#### 8.4 Troubleshooting (4) TRIP [Options]

Display	Symptom	Check Item	Corrective Action
TRIP: WATER LEAKAGE	Water leakage	Tube fitting loose	Tighten fittings
		Instruments are in failure	Replace instruments
TRIP: BACK PRESS. HIGH	Exhaust pressure rises. (0.1 MPa)	Exhaust valve is closed	Check exhaust piping
		Instruments are in failure	Replace instruments
TRIP: EMG. STOP SWITCH	Emergency stop switch	Stop by emergency stop button	Check that pump can be operated and turn the button head to reset

After taking corrective action, input RESET signal or push RESET button. The pump will not RESET while the cause of the TRIP remains. In remote operation mode, interrupt external START signal before resetting.



**WARNING**

Interrupt Earth Leakage Breaker (ELB) or CB and lock out power before starting on wiring and maintenance work.

Do not switch on the power supply to the pump until work is completed.



**WARNING**

The pump casing and exhaust piping become extremely hot during operation and for some time after stopping.

Keep pump and exhaust piping away from contact with personnel and flammable substances.

Do not remove the pump cover during operation.



**WARNING**

Check for gas leaks after installing and maintaining the piping.

Gas leaks will result in the discharge of harmful and dangerous substances and in abnormal reactions due to the admission of air into the pump

## **Appendix 2**

### **Safety Interlocks**

In compliance with SEMI S2, *Safety Guidelines for Semiconductor Manufacturing Equipment*, EBARA A Dry Vacuum pumps include a set of safety interlocks, which shut down the pump upon detecting a violation of "safe" condition.

The following interlocks are standard equipment on all A Series Pumps:

*Emergency Off (EMO)*: A manually activated button breaks a low-voltage control circuit that, in turn, interrupts line power. Restarting the pump(s) requires a manual reset of the twist-lock button. Design implementation of this important interlock can take diverse forms based on process tool specifications and fab electrical distribution. Typical variations include:

*Pump-only EMO*: A button, mounted on or near the pump, controls activating power to the pump motor starter relay(s). Activation interrupts all electrical energy beyond the pump control panel.

*Tool EMO*: A button, included in an interface panel, connects in series ("daisy chain") with a set of EMO buttons. Activating any of the buttons de-energizes contactor coils in the tool distribution panel and interrupts power to the process tool and its ancillary equipment, including the pump(s).

*Gang EMO*: A button, mounted near a set of pumps, controls power to the coil of a contactor feeding a distribution panel. Activation cuts power to the entire panel.

### **Nitrogen Flow Low**

A flow sensor trips when nitrogen supply to the pump (oil bearing(s) and inter-stage injection) drops below its factory set point, opening the motor starter relay(s) and shutting down the pump. Restoration of sufficient nitrogen flow permits restarting the pump.

### **Motor Overload**

Motor overload relays protect the pump motor(s) from overheating due to extended current draws in excess of the motor rating without tripping due to current transients such as start up inrush current. Current (for each phase of line power) passing through a coil heats a bimetallic element simulating motor heating under load. Under a persistent overload condition, differential expansion of the bimetallic element opens a contact, which interrupts the motor run circuit. A brief cool down interval permits restarting the pump.

### **Overcurrent Protection**

The nearly instantaneous current rise from a line-to-line or line-to-ground short very rapidly heats a thermal element in the circuit breaker, opening of a snap action switch and interrupting all power to the electrical panel. Manual reset, which requires clearing the fault condition, is necessary before restarting the pump. The circuit breaker also serves as a lockable interrupt device for servicing the pump system.

---



---

The following interlocks are available as customer-specified options on A Series pumps for toxic/flammable/pyrophoric applications:

**Exhaust Purge (Dilution) Nitrogen Flow Low**

A flow switch trips when nitrogen supply to the exhaust line drops below the field-adjustable set point, opening the motor starter relay(s) and shutting down the pump. Restoration of sufficient nitrogen flow permits restarting the pump. Users must determine appropriate flow setting based on process gas types and amounts found in the pump exhaust stream.

**Cabinet Exhaust Pressure High (Cabinet Exhaust Flow Low)**

A "spool piece" mounted on the cabinet exhaust port and connected to the user's exhaust system provides a mounting point and sense tap for a differential pressure switch, which detects vacuum level in the exhaust line. If the pressure differential between the exhaust vacuum and atmosphere (inside the pump enclosure) drops below the level required to maintain sufficient exhaust flow, the normally-closed contacts in the pressure switch break, opening the motor starter relay(s) and shutting down the pump. Because vacuum pumps typically operate unattended, the interlock does not provide visual and audible alarms. Restoration of differential pressure, and thereby cabinet exhaust flow, permits restarting the pump. The spool also provides an auxiliary port ( $\frac{1}{4}$ " tube) for connection of a vacuum gauge/manometer or insertion of a hot-wire anemometer to measure exhaust parameters.

**Additional Sensor (Optional)**

*Liquid Leak Detector:* While not a safety interlock, a leak detector installed in the pump serves the function of providing protection for personnel and equipment. A controller senses resistance between two conductive elements in the base of the pump. The presence of moisture reduces this resistance below a set point, and the controller ports a signal to the pump CPU, stopping the pump.

**Optional Features Note**

*Cabinet Exhaust Flow Sensor and Liquid Leak Sensor:* Strict compliance with SEMI S2-93A (and S2-0200) requires a cabinet exhaust flow interlock and a leak detector. Most customers find incorporating these features, as needed, into facilities sensors is more economical than including the capability with each individual pump. See Appendix 3.

---

## Appendix 3

### EBARA Dry Pumps and SEMI S2-93A (S2-0200)

In many cases, strict compliance with all aspects of the SEMI health and safety guidelines is not the most desirable or economical way to meet the customer's actual needs. ETI technical staff can assist the user's equipment engineers and safety professionals in selecting the best practices for a specific installation. An appropriate guideline is evaluation of the intended *installed* configuration of the **system**, including the pump, process tool, power distribution and facilities. Items in question include:

#### Circuit Breaker

As a general practice equipment manufactured in the U.S. employs thermal-magnetic circuit breakers for overcurrent protection. SEMI S2 further requires that these circuit breakers have a minimum of 10,000 AIC (amp interrupt capacity). Many EBARA pumps, following the common Japanese practice, employ an earth leakage breaker. Connecting the pump to an appropriately rated circuit breaker in a distribution panel creates a system that meets the SEMI requirements.

#### Lockout – Tagout

A nearby distribution panel may also be an appropriate location for the lockout-tagout bracket.

#### Exhaust Dilution Flow Sensor

For pumps requiring auxiliary nitrogen in the exhaust, ETI offers a hardware-only, normally open flow switch. However, the standard configuration is a firmware-driven shutdown, executing through the pump processor and preserving an explanation of the trip.

#### Cabinet Exhaust Flow

Most customers prefer to monitor the condition of exhaust systems at the facility level rather than the pump level.

#### Liquid Leak Detector

Because cooling water leaks **inside a pump enclosure** are extremely rare, most users find that a liquid leak detector in each pump represents an unnecessary expense. Moisture sensors on the subfab floor can detect a leak either from within a pump or from the utility piping.

#### EBARA Dry Pumps and Ergonomics

SEMI S8-95, *Safety Guidelines for Ergonomic/Human Factors Engineering of Semiconductor Manufacturing Equipment*, which is referenced in SEMI S2, specifies height ranges for location of equipment controls and emergency off (EMO) buttons. The minimum height exceeds the **overall** height of some EBARA A Series dry pumps.

Because vacuum pumps run unattended for long periods of time, EBARA's technical staff believes that relocating the infrequently used controls is unwarranted. Should your vacuum pump application require frequent manual operation of the controls, you may contact your sales representative or the nearest EBARA office for assistance in mounting the controls at a convenient height.

---

## **Appendix 4**

### **Leak Check Procedure**

**NOTE:** This general procedure is not a substitute for user's work instructions or leak detector operations manual. Read and follow the instructions for your leak detection apparatus.

Perform leak check after initial system assembly and after any breach of the system for maintenance.

Check pump down time (that is time to go from atmosphere to target pressure) of foreline to confirm the absence of gross leaks.

For vacuum systems and process pump exhaust lines, pressurize the system with helium and run the probe ("sniffer") of a mass spectrometer leak detector around all joints, seals and fittings.

Realign joints, tighten fittings, replace seals, etc.

Repeat as necessary to eliminate all leaks.

Disconnect helium supply and place system in operating condition.

---

## **Appendix 5**

### **Returning Pumps for Rebuild in U.S.**

In the United States, returned pump shipments must conform to Department of Transportation regulations:

- Hermetically seal contaminated equipment in two (2) heavy gauge polyethylene bags or equivalent.
- Tag or label equipment stating the possible hazardous material and/or the environment in which it was used.
- Obtain an RMA number from the EBARA Service department and post on all bags, containers, and packing list along with a copy of the Environmental Health & Safety Clearance Form.

Failure to observe these procedures may delay the processing and rebuilding of your pump.

---