



Instruction Manual (C)

SCU-800 Control Unit

<i>Description</i>	<i>Voltage</i>
<i>SCU-800 Control Unit</i>	<i>200 - 240 Va.c. 100 - 120 Va.c.</i>



STP pump consists of the three-volumed Instruction Manuals.

Instruction Manual (A):	STP pump generic Instruction Manual Supplied with STP pump
Instruction Manual (B):	STP pump specific information Supplied with STP pump
➔ Instruction Manual (C): (This Instruction Manual)	STP control unit Instruction Manual Supplied with STP control unit



The description of this product consists of the three-volumed Instruction Manuals. Read through each Instruction Manual before operation.

The separate volume contents of each description are as follows:

Instruction Manual (A)

STP pump generic Instruction Manual:

- Introduction
- Installation of the STP pump
- Installation of the STP control unit
- Operation
- Safety functions
- Maintenance and inspection
- Storage and disposal
- Service, Spares and accessories

Instruction Manual (B)

STP pump specific information:

- Technical data
- How to Secure the STP pump
- Temperature Management System (TMS)

Instruction Manual (C)

STP control unit Instruction Manual:

- Introduction
- Technical data
- Installation
- Operation
- Serial communication protocol
- STP-Link (except for SCU-750)
- Maintenance
- Storage, transportation and disposal
- Service, spares, and accessories

Keep the manuals in an easily accessible location.

CONTENTS

Section	Title	Page
1	INTRODUCTION	1
1.1	Scope and definitions	1
1.2	Applied standards	2
1.3	Limited warranty	2
1.3.1	Warranty period	2
1.3.2	Item warranted	2
1.3.3	Disclaimer	2
1.3.4	Spare parts	3
1.4	Labels	3
1.5	Label affixing positions	6
1.6	General description	7
1.6.1	Cable sets	8
2	TECHNICAL DATA	9
2.1	SCU-800 specifications	9
3	INSTALLATION	13
3.1	Unpacking	13
3.2	Front panel	13
3.3	Rear panel	16
3.4	Precautions before installation	17
3.4.1	Operating environment	17
3.4.2	Insulation test	17
3.4.3	Installation area	18
3.5	Attaching the SCU-800 to a rack	19
3.6	Cable connection	20
3.6.1	STP connection cable	20
3.6.2	TMS connection cable	22
3.6.3	Power cable	23
3.7	Connecting to semiconductor equipment	25
3.7.1	Connecting to power	25
3.7.2	Emergency off circuit (EMO circuit)	25
3.8	Remote communication	26
3.8.1	Parallel communication	26
3.8.2	Serial communication	26
3.9	Adjustment methods	27
3.9.1	Tuning	27
3.9.2	Tuning method	27
3.9.3	Change of data after tuning	29
3.10	Confirmation mode	30
3.10.1	Confirmation method	30
3.11	Parameter set mode	32

CONTENTS (CONTINUED)

Section	Title	Page
3.11.1	Remote operation setting	32
3.11.2	Rotational speed setting	32
3.11.3	TMS setting	32
3.11.4	Rotational inhibit signal setting	32
3.11.5	Emergency vent valve setting	32
3.11.6	Second Damage Limit	33
3.11.7	Pump air-cooling fan output setting	33
3.11.8	Warning function setting	34
3.11.9	Serial port COM1 setting	35
3.11.10	Serial port COM2 setting	35
3.11.11	Serial port COM3 setting	35
3.11.12	Date/Time setting	35
3.11.13	Factory setting	35
3.11.14	Parameter setting procedure	36
3.12	Manual operation mode	42
4	OPERATION	43
4.1	Before starting the STP pump	43
4.1.1	Confirmation before starting	43
4.1.2	Confirmation of vacuum system	43
4.2	Powering ON	44
4.2.1	Self test	44
4.2.2	"CAUTION" message in the self test state	44
4.3	How to start/stop the STP pump	45
4.4	Manual start/stop the STP pump	45
4.4.1	Starting the STP pump	45
4.4.2	Stopping the STP pump	45
4.4.3	Starting the STP pump after stopping	45
4.5	Remote operation	47
4.5.1	Input signal pins	47
4.5.2	Output signal pins	49
4.5.3	Remote setting	52
4.5.4	Starting/Stopping the STP pump	52
4.6	Rotation INHIBIT signal	53
4.6.1	Starting the STP pump after stopping	54
4.6.2	Starting the STP pump after a safety function operates	54
4.7	Powering OFF	54
4.8	Operating the TMS unit (for use with the TMS unit)	55
4.8.1	Before starting	55
4.8.2	Starting/Stopping	55
4.8.3	Setting the TMS unit function	55
4.8.4	Temperature control	55

CONTENTS (CONTINUED)

Section	Title	Page
5	SERIAL COMMUNICATION PROTOCOL	57
5.1	Introduction	57
5.2	Connection and setting up	57
5.2.1	Signal connection	57
5.2.2	Connecting the RS485	60
5.2.3	Communication parameter setting	61
5.3	Protocol specifications	61
5.3.1	General description	61
5.3.2	Standard transmission frame (in the RS232/RS485 single point connection)	62
5.3.3	Control command (in the RS232/RS485 single point connection)	63
5.3.4	Query command (in the RS232/RS485 single point connection)	64
5.3.5	Transmission data format	65
5.3.6	Frame control (checksum)	66
5.3.7	Error control	66
5.3.8	Transmission frame in the RS485 multi-point connection	66
5.3.9	Control command in the RS485 multi-point connection	68
5.3.10	Query command in the RS485 multi-point connection	69
5.3.11	Broadcasting command in the RS485 multi-point connection	70
5.4	Command specifications	71
5.4.1	Command list	71
5.4.2	ReadMeas	72
5.4.3	Command	72
5.4.4	ReadFailMess	73
5.4.5	ReadModFonct	76
5.4.6	ReadVersion	78
5.4.7	ReadCounters	79
5.4.8	ReadSetPoint	80
5.4.9	ReadMotorTemp	80
5.4.10	ReadStatus	81
5.4.11	ReadEvents	82
5.4.12	SetSpeedSetPoint	83
5.4.13	ReadSpeedSetPoint	84
5.4.14	ReadModFonctWithWarning	85
5.4.15	ReadMeasValue	88
6	STP-LINK	91

CONTENTS (CONTINUED)

Section	Title	Page
7	MAINTENANCE	93
7.1	Safety functions	93
7.1.1	Power failure	93
7.1.2	Operation after a power recovery	94
7.1.3	Abnormal state of magnetic bearing	94
7.1.4	Excessive vibration	95
7.1.5	Motor driver overload	95
7.1.6	Overheating inside the STP pump	95
7.1.7	Overheating inside the SCU-800	95
7.1.8	Overspeed	95
7.1.9	Abnormality/Error in the TMS unit (for use with the TMS unit)	96
7.1.10	Failure of the air-cooling fan	96
7.2	"WARNING" message function	97
7.2.1	"WARNING" message display function	97
7.3	"WARNING" message description	98
7.3.1	Damage point function	98
7.3.2	First damage limit	98
7.3.3	Second damage limit	98
7.3.4	Imbalance X_H, X_B, Z	99
7.3.5	Pump run time over	99
7.3.6	Pump overload	99
7.3.7	Low RTC battery	99
7.4	"WARNING" function setting	100
7.5	Error at self test state	101
7.5.1	Error after self test	102
7.5.2	Error messages	102
7.5.3	Troubleshooting immediately after power failure occurs	102
7.5.4	Troubleshooting immediately after other abnormality/errors occur	103
7.6	When error message is not displayed on LCD	111
7.6.1	Abnormalities when powering ON	111
7.6.2	Abnormalities when performing rotational operation	111
7.6.3	Other abnormalities	112
7.7	"Error Record" message display function	112
7.8	Maintenance and inspection	113
7.8.1	Replacing the fuses	113
7.8.2	Cleaning	114
7.8.3	Overhaul	114
8	STORAGE, TRANSPORTATION AND DISPOSAL	115
8.1	Storage of the SCU-800	115
8.1.1	Transporting for repair or overhaul	115
8.2	Disposal	116

CONTENTS (CONTINUED)

Section	Title	Page
9	SERVICE, SPARES AND ACCESSORIES	117
9.1	Introduction	117
9.2	Service	117
9.3	Spares	117
9.4	Accessories	118

ILLUSTRATIONS

Figure	Title	Page
1	High voltage device caution label	3
2	Voltage caution label	4
3	Safety instruction label	4
4	Connector caution label	4
5	Voltage rating label	5
6	Label affixing positions	6
7	SCU-800 control unit	7
8	Configuration of the STP pump with the TMS	8
9	SCU-800 dimensions (mm)	11
10	SCU-800 front panel	13
11	SCU-800 rear panel	16
12	Installing the SCU-800	18
13	Example of securing the SCU-800	19
14	STP pump connection cable	20
15	TMS connection cable (standard)	22
16	TMS connection cable (STP-A1603 series)	22
17	Power cable	23
18	Connecting method of the power cable without plug	24
19	REMOTE X7 connector	26
20	Connector X3A, X3B, X6 (D-sub 9)	26
21	Tuning procedures	28
23	Parameter setting method	37
24	Parameter setting method (continued)	38
25	Parameter setting method (continued)	39
26	Parameter setting method (continued)	41
27	Manual operation method	42
28	Operational procedures	46
29	REMOTE X7 input signal pins	49
30	REMOTE X7 output signal pins	51
31	Serial communication	57
32	Connector X3A/X3B (D-sub 9)	58
33	Connector X6 (D-sub 9)	58
34	RS485 connections	60
35	PC to SIM communication	61

TABLES

Table	Title	Page
1	Turbomolecular pumps	7
2	SCU-800 front panel functions	14
3	SCU-800 front panel functions (continued)	15
4	SCU-800 rear panel connection	16
5	STP connection cable specification	21
6	Power cable	24
7	User setting data list	29
8	Causes of "CAUTION" at the self test state	44
9	REMOTE X7 input signal pins	48
10	REMOTE X7 output signal pins	50
11	Rated contacts for relays CR1 to CR10	52
12	Starting/Stopping the STP pump during remote operation (REMOTE X7)	52
13	Rotation INHIBIT signal input	53
14	Reset operation during remote operation (REMOTE X7)	54
15	X3A/X3B pin position	57
16	X6 pin connection	58
17	Communication parameters	61
18	Transmission control characters	62
19	Pump operation commands	70
20	Command list	71
21	Pump operation commands	73
22	Error message values	75
23	Error message values (continued)	76
24	Pump operation mode	77
25	Remote mode	82
26	Warning value bit assign	86
27	Functions of STP-Link	91
28	Backup rotational speed	93
29	States of LCD, LEDs and REMOTE output signals at a power failure	94
30	Accumulated damage point and warning message	98
31	Default setting of "WARNING" function	100
32	Factory setting and variable range	100
33	Error messages at self test state	101
34	Error messages after self test	104
35	Error messages after self test (continued)	105
36	Error messages after self test (continued)	106
38	Error messages after self test (continued)	108
39	Error messages after self test (continued)	109
40	Error messages after self test (continued)	110
41	Troubleshooting when powering ON	111
42	Troubleshooting when performing the STP pump start operation	111
43	Troubleshooting while the STP pump is rotating	112

1 INTRODUCTION

1.1 Scope and definitions

This manual provides installation, operation and maintenance instructions for the Edwards SCU-800 control unit (abbreviated to "SCU-800" throughout this manual) for the Turbomolecular pump (STP). You must use the SCU-800 as specified in this manual.

The procedures in this manual must be followed before you install, operate and maintain the SCU-800. Important safety information is highlighted as WARNING and CAUTION instructions; these instructions are mandatory. The use of WARNINGS and CAUTIONS is defined below.

	WARNING Warnings are given where failure to observe the instruction could result in serious injury or death to people.
---	--

CAUTION Cautions are given where failure to observe the instruction could result minor personal injury in damage to the equipment, associated equipment and/or process.

Note: Items you must follow during operation and maintenance.

Throughout this manual, page, figure and table numbers are sequential.

The units used throughout this manual conform to the SI international system of units of measurement; US equivalent units of measurement are also given.

The following IEC warning labels/symbols appear on the SCU-800:



Warning - refer to accompanying documentation.



Warning - risk of electric shock.



Protective earth (ground).

Note: An alarm function is incorporated into this STP series. Alarm and cautionary messages are displayed on the LCD of the SCU-800. Note that the words "WARNING" and "CAUTION" displayed on the LCD indicate the need for overhaul of the pump or precautions during the operation. They do not have the same meaning as the much more serious symbols for "WARNING" and "CAUTION" used in the instruction manual.

SCU-800 Control Unit for Turbomolecular Pump

1

INTRODUCTION

1.2 Applied standards

The SCU-800 conforms to the following directives and standards:

1. Applied Directives
 - EC Low Voltage Directive
 - EC Electromagnetic Compatibility Directive
2. Applied Standards
 - EN61010-1 / IEC61010-1
 - EN55011(class A)
 - EN61000-6-2
 - UL61010-1 (Electrical Equipment for Measurement, Control, and Laboratory Use)

1.3 Limited warranty

This WARRANTY applies to the customer to whom Edwards has delivered this product.

1.3.1 Warranty period

Edwards warrants this product against defects for a period of two (2) years from the date of delivery or during the period specified in the agreement made by and between the customer and Edwards.

1.3.2 Item warranted

1. This warranty applies only to the product delivered from Edwards to the customer.
2. If any defect is found during this period, Edwards will, at its option, repair or recondition the product free of charge. The costs for repair or replacement of the product after the warranty period has passed will be at your own charge.

1.3.3 Disclaimer

Edwards makes no warranty with respect to any damage occurred due to any of the following during the warranty period:

1. Handling, operation or maintenance other than that specified herein.
2. Failure to follow any of the warnings or cautions enumerated in this manual.
3. Installation, operation or maintenance using parts which are not specified by Edwards.

SCU-800 Control Unit for Turbomolecular Pump

4. Maintenance personnel other than those authorized by Edwards or Service office have disassembled, reconditioned, or tampered the product.
5. Defect resulting from the not-specified use of the product.
6. When the product is used under special conditions without obtaining the written consent of Edwards (strong magnetic field and the radiation are added to the product).
7. Defect resulting from the installation of the product (exclude the installation by authorized personnel).
8. Deterioration in the external because of use (discoloration, scratches and so forth).
9. Product damage occurred during transport or other factors not attributable to Edwards.
10. Product breakage or damage due to natural disasters, fire or other external factors.
11. Deterioration in the basic performance due to the use of the product beyond limits of the use.
12. Any direct, incidental or consequential damage resulting from the use of the product.
13. When continuously operated without overhaul after the WARNING indication ("WARNING" message) on the LCD.
14. Overhaul and replacement of maintenance parts.

1.3.4 Spare parts

- Air-cooling fan for SCU-800. (When exchanging, contact Service office).

1.4 Labels

The following labels are affixed or printed to the SCU-800. Read the contents of the labels before operation.

1. High voltage device caution label

The SCU-800 is equipped with a high voltage device. This label warns operators to pay attention to the high voltage device at the maintenance and inspection.

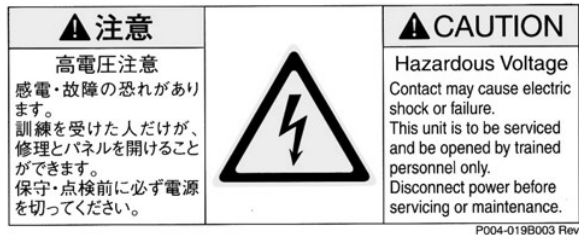

Figure 1 - High voltage device caution label

SCU-800 Control Unit for Turbomolecular Pump

2. Voltage caution label

This label describes precautions for operating the TMS unit.
Use the specified heater and valve when connecting the TMS unit to the STP pump.

▲ 注意		▲ CAUTION	
◇TMSユニット使用時はヒータ・バルブの電圧表示を確認し、表示に合った入力電圧で使用してください。異なる電圧で使用した場合、ヒータ・バルブが故障する恐れがあります。		◇Before using the TMS unit, always check the voltage specified on its heater and valve. The specified input voltage should be used. If not, the heater and valve may be damaged.	
ヒータ・バルブ表示	入力電圧	Mark on heater and valve	Input Voltage
220V	AC200V-240V~	220V	AC200V-240V~
110V	AC100V-120V~	110V	AC100V-120V~

P004-019B004 Rev.A

Figure 2 - Voltage caution label

3. Safety instruction label

This label describes instructions before operating the SCU-800.

安全上の指示事項	SAFETY INSTRUCTIONS
使用前に取扱説明書をお読みください。	Read instruction manual before operation.

Figure 3 - Safety instruction label

4. Connector caution label

This label describes lock of the connector.
The label instructs operators to prevent the connectors from being disconnected while the STP pump is in operation.

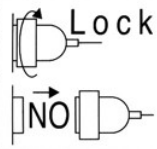
▲ 注意	Lock	▲ CAUTION
感電や故障の原因になります。 ◇コネクタは確実にロックしてください。 ◇ブレーカONの時はコネクタを外さないでください。		Improper connection may cause electric shock or failure. ◇Lock connector securely. ◇Do not remove connector while breaker is ON.

P004-019B005 Rev.-

Figure 4 - Connector caution label

SCU-800 Control Unit for Turbomolecular Pump

5. Voltage rating label

This label describes the rated voltage of the SCU-800. Use voltage specified in this label. Some pumps can be operated in the input voltage between 100 - 120V inclusive. Confirm the specific pumps in Section 2, "TECHNICAL DATA".

AC100-120V /200-240V ~

	AC200-240V~ 50/60Hz	AC100-120V~ 50/60Hz
without TMS	850VA MAX	800VA MAX
with TMS	1200VA MAX	800VA MAX
P049		P004-0198008 Rev. A

5-a

5-b

Figure 5 - Voltage rating label

SCU-800 Control Unit for Turbomolecular Pump

1.5 Label affixing positions

Refer to Section 1.4 for the details of the labels 1 to 5.

1

INTRODUCTION

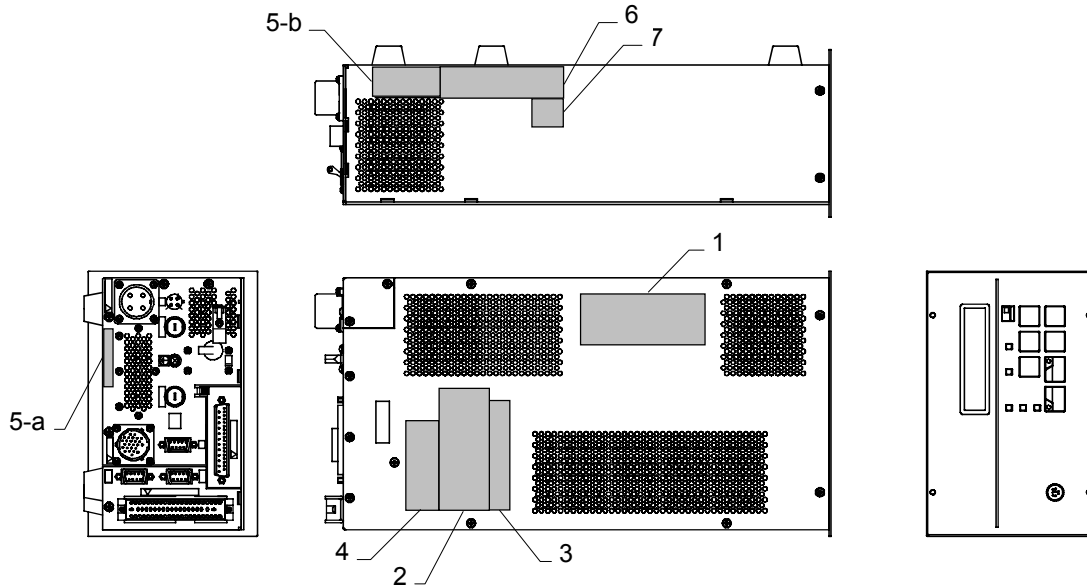

Figure 6 - Label affixing positions

- 1 High voltage device caution label
- 2 Voltage caution label
- 3 Safety instruction label
- 4 Connector caution label
- 5-a Voltage rating label
- 5-b Voltage rating label
- 6 Name plate
- 7 Parts number

SCU-800 Control Unit for Turbomolecular Pump

1.6 General description

The SCU-800 is the control unit required to drive the STP series of turbomolecular pumps. The SCU-800 converts the single-phase line supply voltage into a 3-phase d.c. voltage to drive the pump motor. It also evaluates measured signals and performs the following functions:

- It provides logic to control the pump functions.
- It operates the magnetic bearing system.
- It operates the optional Temperature Management System (TMS).

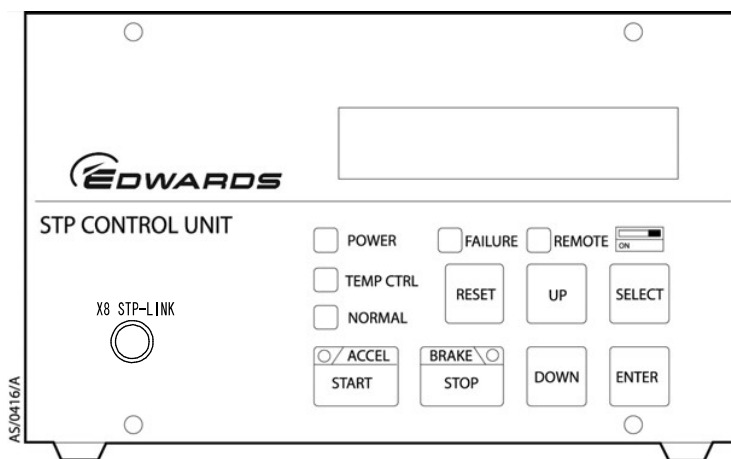

Figure 7 - SCU-800 control unit

The following series of turbomolecular pumps can be used in conjunction with the SCU-800.

Model Name	Specification
STP-603/1003 series	Ultra-high vacuum type
STP-H301/H451 series	High-throughput type
STP-H803/H1303 series	High-throughput type
STP-A803/A1303 series	Advanced high-throughput type
STP-A1603 series	Advanced high-throughput type

Table 1 - Turbomolecular pumps

SCU-800 Control Unit for Turbomolecular Pump

1.6.1 Cable sets

The following cable sets (optional accessories) are used with the SCU-800 and STP pump:

- STP connection cable - STP pump to SCU-800.
- TMS cable - STP pump to built-in TMS unit in the SCU-800.
- Power cable - SCU-800 to power supply.

Note: Figure 8 shows a typical TMS system installation. System connections and cables differ according to the type of pump connected to the SCU-800. Refer to the STP pump Instruction Manual (A) and (B) for full details of connection cables and system connections.

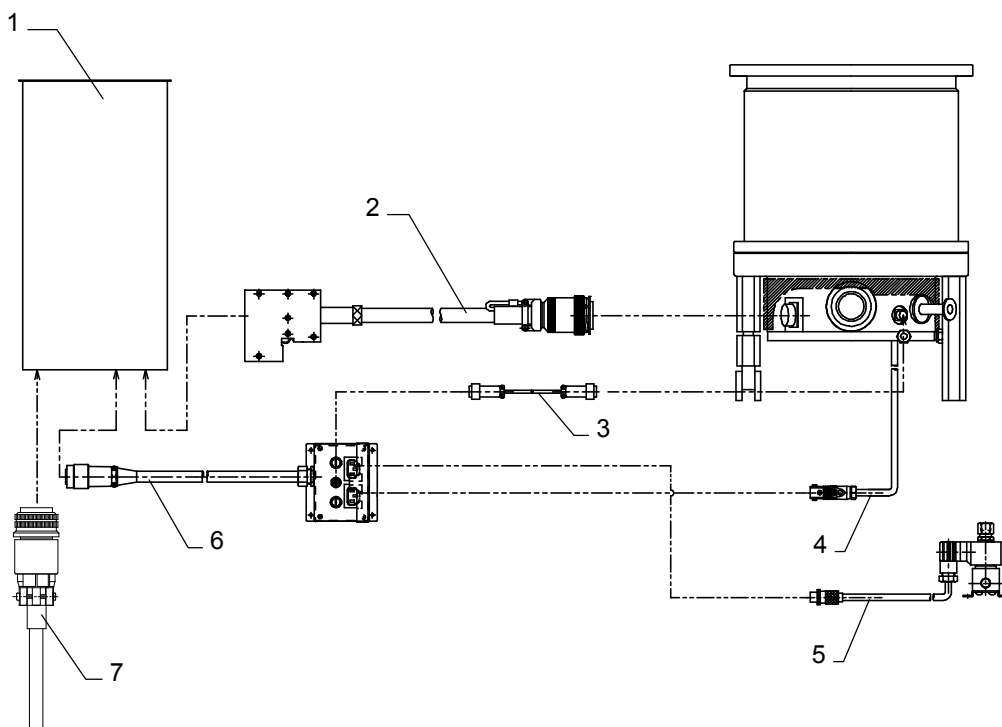

- | | |
|------------------------|------------------------|
| 1 SCU-800 control unit | 5 TMS valve cable |
| 2 STP connection cable | 6 TMS connection cable |
| 3 TMS sensor cable | 7 Power cable |
| 4 TMS heater cable | |

Figure 8 - Configuration of the STP pump with the TMS

2 TECHNICAL DATA

2.1 SCU-800 specifications

Applicable pump		STP-603/1003 series STP-H301/H451 series STP-H803/H1303 series STP-A803/A1303 series STP-A1603 series
Input voltage:	For STP-603/1003 series	100 to 120 Va.c. \pm 10%, 200 to 240 Va.c. \pm 10%
	For STP-H301/H451 series	100 to 120 Va.c. \pm 10%, 200 to 240 Va.c. \pm 10%
	For STP-H803/H1303 series	200 to 240 Va.c. \pm 10%
	For STP-A803/A1303 series	200 to 240 Va.c. \pm 10%
	For STP-A1603 series	200 to 240 Va.c. \pm 10%
Input power:	Without TMS unit	850 VA maximum
	With TMS unit	1200 VA maximum
Input frequency		50/60 \pm 2 Hz
Leakage current		3.5 mA maximum
Input phase		Single phase
Main breaker specification	Rated current	15 A
	Ampere Interrupting Capacity (AIC)	1000 A (240 Va.c., 50/60 Hz)
Motor driving system		3-phase d.c. brushless motor driver
Output voltage under normal operation		92 Va.c. maximum
Output frequency under normal operation		800 Hz maximum
Allowable ambient temperature		0 to 40 °C (32 to 104 °F)
Storage temperature		-25 to 55 °C (-13 to 131 °F)
Mass (except the optional accessory)		9 kg (26.4 lb)
Dimensions		Refer to Figure 9
TMS control unit		Built in
Battery for clock function	Specification	Lithium battery, 3 V, 130 mAh
	Model	DS9034PCX
	Maker	MAXIM
Serial communication function		RS232/RS485

SCU-800 Control Unit for Turbomolecular Pump

2

TECHNICAL DATA

Operation switch	START	(Push-button switch•Green)
	STOP	(Push-button switch•Dark Grey)
	RESET	(Push-button switch•Grey)
	SELECT	(Push-button switch•Grey)
	UP	(Push-button switch•Grey)
	DOWN	(Push-button switch•Grey)
	ENTER	(Push-button switch•Grey)
	MANUAL/REMOTE changeover	(Slide switch•White)
Panel indication LED	ACCEL.	(Green LED)
	NORMAL	(Green LED)
	BRAKE	(Green LED)
	TEMP CTRL	(Green LED)
	POWER	(Green LED)
	FAILURE	(Red LED)
	REMOTE	(Green LED)
Panel display	LCD	(2 lines of 20 characters)
Input/Output terminal	AC POWER X2	(3 pins)
	P.CONNECTOR X1	(60 pins)
	TMS X5	(26 pins)
	REMOTE X7	(37 pins)
	COM1 X3A/X3B	(9 pins x 2)
	COM2 X6	(9 pins)
	STP-LINK X8	(8 pins)
Safety function	Electromagnetic bearing failure detection	
	STP pump overheat detection	
	Motor driver overload detection	
	Power failure detection	
	STP pump overspeed detection	
	STP control unit overheat detection	
	TMS unit failure detection	
	Air-cooling fan failure detection	
Other failure detection		

SCU-800 Control Unit for Turbomolecular Pump

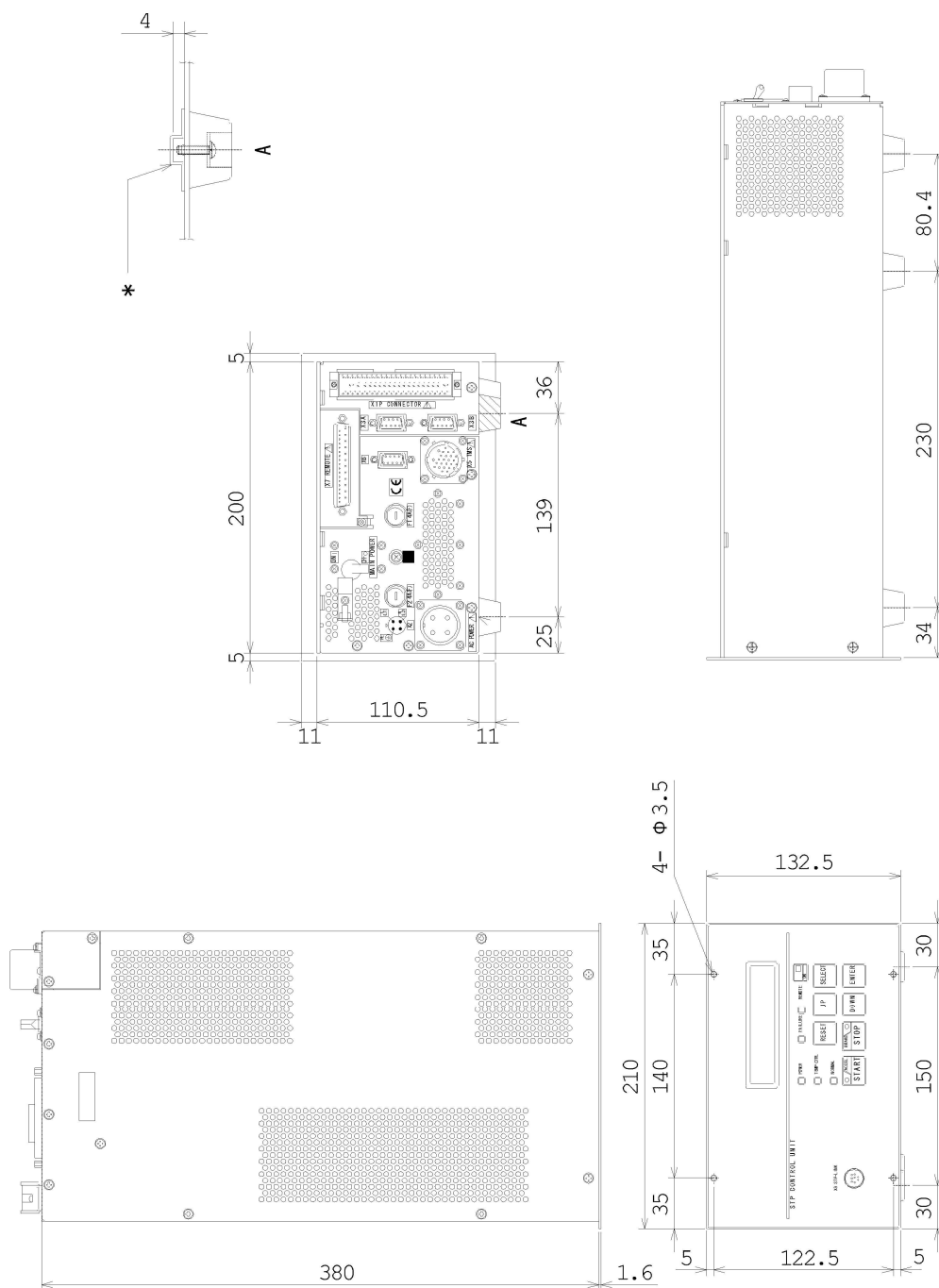

Figure 9 - SCU-800 dimensions (mm)

* Screw stopper

Note: The screw hole sizes for the rubber feet and rack fixation are M3×12.

SCU-800 Control Unit for Turbomolecular Pump

3 INSTALLATION

3.1 Unpacking

Check outer package for damage and that the delivery note corresponds to the purchase order.

Note: It is recommended to keep the packaging materials, such as the corrugated fibreboard container and cushioning material for possible re-use. If the SCU-800 is damaged, return it in its original package and contact Edwards or their distributor.

3.2 Front panel

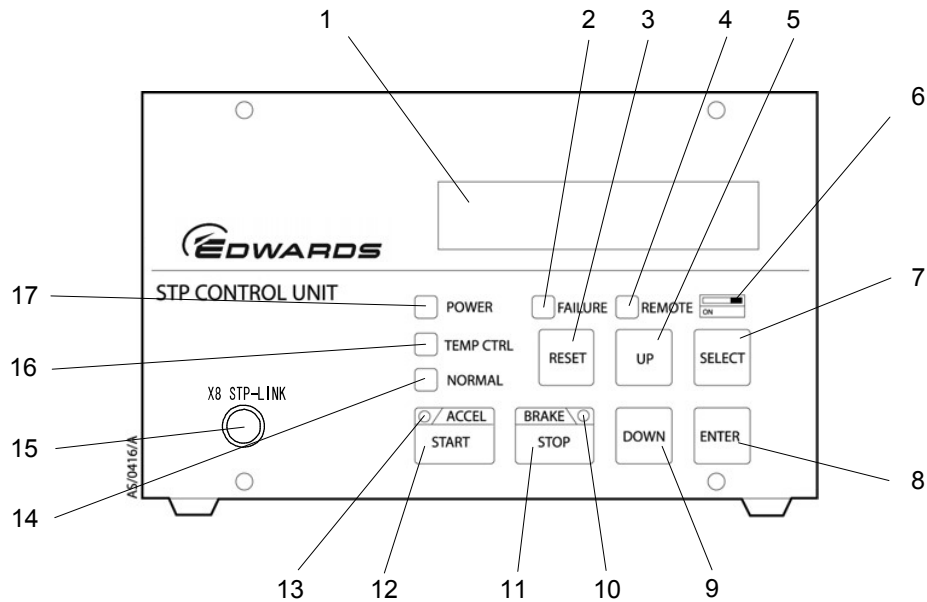

- | | | | |
|---|---------------------------------|----|---------------|
| 1 | LCD panel | 10 | BRAKE LED |
| 2 | FAILURE LED | 11 | STOP switch |
| 3 | RESET switch | 12 | START switch |
| 4 | REMOTE LED | 13 | ACCEL. LED |
| 5 | UP switch | 14 | NORMAL LED |
| 6 | MANUAL/REMOTE changeover switch | 15 | STP-LINK X8 |
| 7 | SELECT switch | 16 | TEMP CTRL LED |
| 8 | ENTER switch | 17 | POWER LED |
| 9 | DOWN switch | | |

Figure 10 - SCU-800 front panel

Note: Refer to Table 2 for front panel functions.

SCU-800 Control Unit for Turbomolecular Pump

Item	Description	Function
1	LCD panel	Displays the STP pump's operational status, speed, error messages, and other.
2	FAILURE LED	(Red LED) Illuminates when an abnormality/error occurs on the STP pump or SCU-800. LCD panel simultaneously displays an error message.
3	RESET switch	(Flat panel switch, grey. Valid in MANUAL only.) Alarm reset function. Tuning function.
4	REMOTE LED	(Green LED) Illuminates when in the REMOTE mode.
5	UP switch	(Flat panel switch, grey. Valid in MANUAL and REMOTE.) Abnormality/error display change function. Setting content confirmation function. Setting content change function.
6	MANUAL/REMOTE changeover switch	(Slide switch, white) Manual/Remote mode changeover.
7	SELECT switch	(Flat panel switch, grey. Valid in MANUAL and REMOTE.) LCD display function (Confirmation mode change and parameter set mode change). Press SELECT and UP switches simultaneously to enter the setting mode.
8	ENTER switch	(Flat panel switch, grey. Valid in MANUAL and REMOTE.) Setting content determination function. Warning message display function.
9	DOWN switch	(Flat panel switch, grey. Valid in MANUAL and REMOTE.) Abnormality/error display change function. Setting content confirmation function. Setting content change function.
10	BRAKE LED	(Green LED) Illuminates during STP pump deceleration (BRAKE state).
11	STOP switch	(Flat panel switch, dark grey. Valid in MANUAL only.) Stops the STP pump.
12	START switch	(Flat panel switch, green. Valid in MANUAL only.) Starts the STP pump.
13	ACCEL. LED	(Green LED) Illuminates during STP pump acceleration (ACCELERATION state).
14	NORMAL LED	(Green LED) Illuminates during STP pump rated speed operational (NORMAL OPERATION state).

Table 2 - SCU-800 front panel functions

SCU-800 Control Unit for Turbomolecular Pump

Item	Description	Function
15	STP-LINK X8	Connector for the dedicated cable (optional accessory) connection to do serial communication with the PC. Monitors the operating condition of the STP pump with the dedicated monitor software "STP-Link" (optional accessory) on the PC screen.
16	TEMP CTRL LED	(Green LED) illuminates when the TMS unit is (optional accessory) operational.
17	POWER LED	(Green LED) Illuminates when power is on. Extinguishes when backup power is being supplied.

Table 3 - SCU-800 front panel functions (continued)

SCU-800 Control Unit for Turbomolecular Pump

3.3 Rear panel

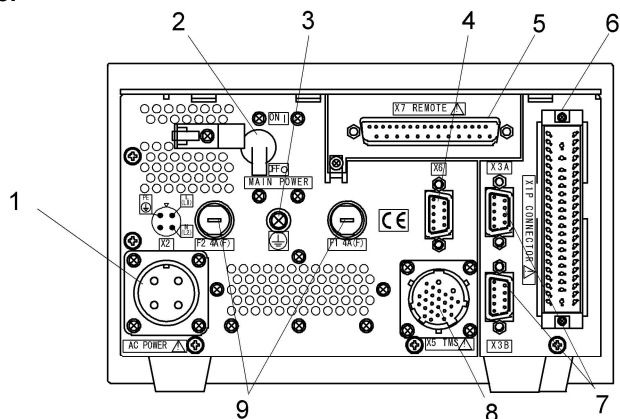

- | | |
|-----------------------|-----------------------------|
| 1 AC POWER X2 | 6 P.CONNECTOR X1 |
| 2 MAIN POWER breaker | 7 Serial port COM1 X3A, X3B |
| 3 Ground terminal | 8 TMS X5 |
| 4 Serial port COM2 X6 | 9 Fuse F1, F2 |
| 5 REMOTE X7 | |

Figure 11 - SCU-800 rear panel

WARNING

A hazardous live voltage may exist at the connectors that are marked with the warning sign . DO NOT touch the terminal. Doing so may result in electric shock. When connecting/disconnecting the connector, always power off the SCU-800 (turn the MAIN POWER "OFF") and isolate (Lockout/Tagout) the electrical energy source, water and gas, and other energy sources on the vacuum equipment.

Item	Description	Function
1	AC POWER X2	Main power connection (240 Va.c. maximum)
2	MAIN POWER breaker	Main power circuit breaker
3	Ground terminal	Ground (Earth) connection terminal
4	Serial Port COM2 X6	Serial communication connection RS485
5	REMOTE X7	Remote connection (125 Va.c. maximum)
6	P.CONNNECTOR X1	STP pump connection (92 Va.c. maximum)
7	Serial Port COM1 X3A/X3B	Serial communication connection RS232/RS485 (shard use)
8	TMS X5	TMS unit connection (240 Va.c. maximum)
9	Fuse F1, F2	Fuses for TMS unit (optional accessory)

Table 4 - SCU-800 rear panel connection

SCU-800 Control Unit for Turbomolecular Pump

3.4 Precautions before installation

CAUTION

When removing or installing the pump or at maintenance and inspection, follow the precautions below. Failure to do so might hurt your back or cause injuries due to occurrence of an accident CAUTION such as fall.

- Use a crane or the like when lifting the heavy product of 18 kg or more.
- When lifting STP control unit with handles, support bottom of STP control unit, do not have only handle.

CAUTION

DO NOT move the STP pump and the STP control unit while the STP pump is in operation. Doing so may result in product damage.

3.4.1 Operating environment

The SCU-800 should be installed in an area which meets the following requirements. Be sure the ambient temperature of the control unit during STP pump operation:

Ambient temperature	0 to 40 °C (32 to 104 °F)
Ambient relative humidity	30 to 95 % (non condensing)
Environment	An area free of exposure to direct sunlight, high humidity, dust, salty air, dripping water, explosive or flammable gas, corrosive gas, radiation, strong magnetic and electric fields, excessive vibration and sources of electric noise
Installation condition	Install the SCU-800 horizontally (within ± 10 degrees)

3.4.2 Insulation test

CAUTION

The varistor for the power supply line protection is installed in the SCU-800. DO NOT perform the insulation test with the varistor installed. Doing so may result in product damage.

DO NOT perform an insulation test on the SCU-800. When performing the insulation test on your equipment, ensure that you disconnect the SCU-800 from the equipment that is to be insulation tested, so that the test voltage is not applied to the SCU-800.

SCU-800 Control Unit for Turbomolecular Pump

3.4.3 Installation area

CAUTION

The minimum bending radius of the STP connection cable is 100 mm (4").
DO NOT bend the cables excessively and beware of any obstacles when installing the SCU-800.
 In addition, leave enough space to install other cables without bending them excessively.

When installing the SCU-800, leave enough space for the following (refer to Figure 12):

- Space for maintenance and inspection.
- Space for inlet and outlet cooling air:
 Top and side: 50 mm (1.97") or more.
 Bottom: 14.5 mm (0.57") or more (height of the rubber feet).
- Space for connecting the cables:
 Rear: 200 mm (8.0") or more.

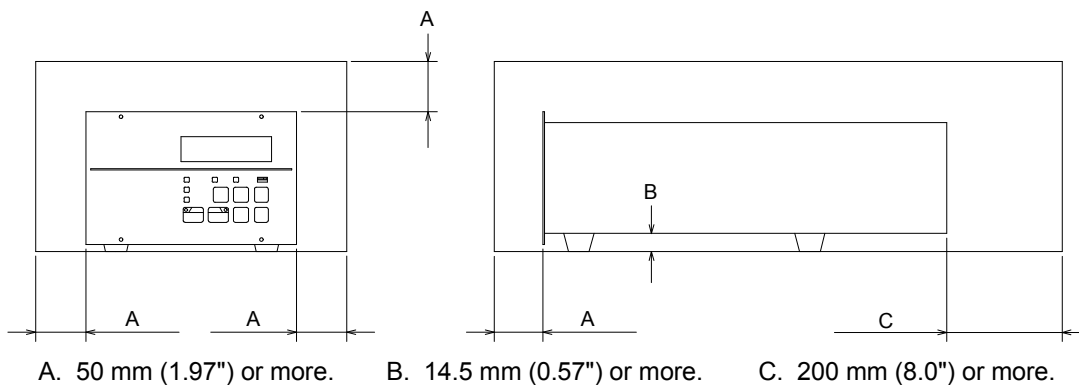

Figure 12 - Installing the SCU-800

SCU-800 Control Unit for Turbomolecular Pump

3.5 Attaching the SCU-800 to a rack

CAUTION

The SCU-800 cannot be supported with only the 4 screws on the front panel. Always support it from the bottom using a support angle. When installing the SCU-800, DO NOT block the ventilation port of the SCU-800 by the support angle or other things. It will cause the SCU-800 to overheat.

The dimensions of the SCU-800 front panel conform to EIA standards. Therefore, this panel can be attached to any type of commercially available rack. Attach the SCU-800 as follows:

Note: For the dimensions of the front panel and positions of the screw holes for the rubber feet, refer to Figure 10 and Figure 13.

- Attach the front panel to the rack using the 4 screws Figure 13 (1).
- Support the SCU-800 from the bottom using a support angle Figure 13 (2) or a similar tool.
- When attaching the SCU-800 to a movable rack, to protect the SCU-800 during transport, remove the rubber feet from the bottom and attach the SCU-800 to the rack using the screw holes for the rubber feet.

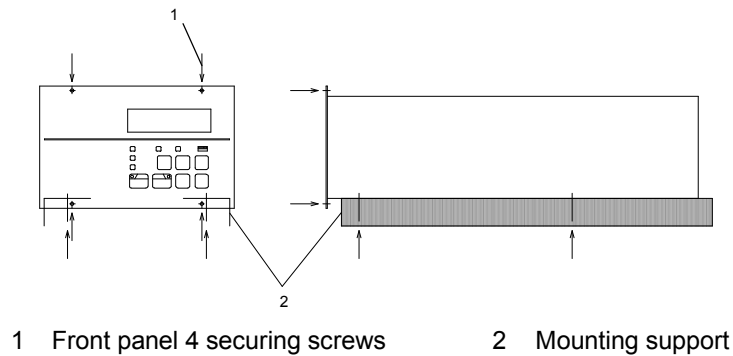

Figure 13 - Example of securing the SCU-800

SCU-800 Control Unit for Turbomolecular Pump

3.6 Cable connection

3

INSTALLATION



WARNING

When connecting/disconnecting cables, always power off the STP pump (switch the SCU-800 MAIN POWER to "OFF") and isolate (Lockout/Tagout) the electrical energy source, water and gas, and other energy sources on the vacuum equipment. Failure to do so may result in the inadvertent rotation of the STP pump which may result in an accident, an electric shock or damage to equipment. An accident caused by water leaks or gas leak may occur.



WARNING

DO NOT remove the connector while the pump is rotating. The voltage might be output to connector according to the rotational speed, and it causes the electric shock or the failure.

CAUTION

Use the STP connection cable and the power cable that Edwards has specified. The use of other cables may result in product damage. Align the position of the guide key of the connectors and insert vertically so as not to bend the pins. If a pin is bent, not only may the connector not function normally, but it may make the pins contact, resulting in a malfunction. Lock and securely tighten each connector and screw.

CAUTION

Connect each cable securely with caution, avoiding any obstacles. DO NOT place heavy objects on the cables or bend them excessively. Support each cable so as not to apply direct force to the connectors or terminals. If any problem occurs in cables, connectors or terminals, the STP pump may not function normally. DO NOT apply voltage to each connector pin and DO NOT cause any short-circuiting between pins. Install cables so that personnel are not exposed to risk of tripping or falling.

SCU-800 Control Unit for Turbomolecular Pump

3.6.1 STP connection cable

Connect the receptacle (socket) side of the STP connection cable to the STP connector on the STP pump and connect the plug (pin) side to "P.CONNECTOR X1" on the SCU-800.

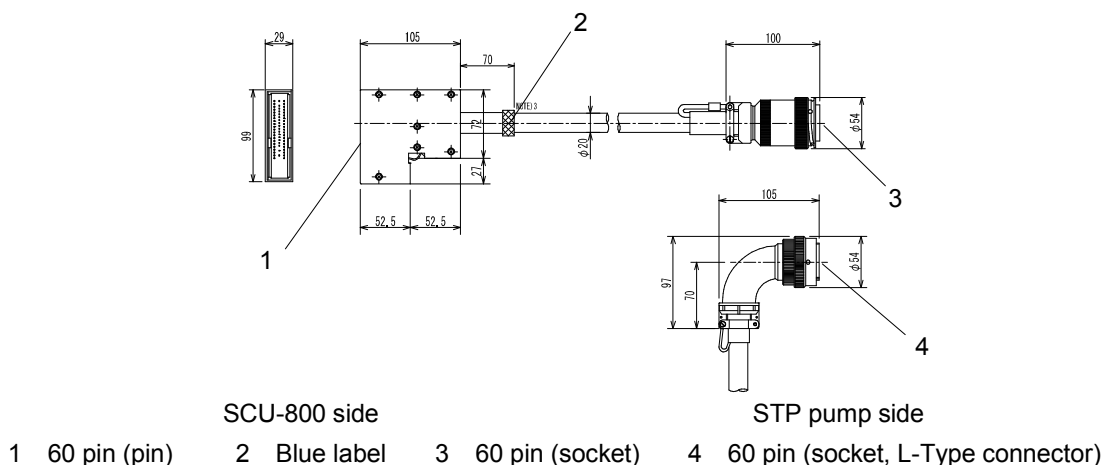

Figure 14 - STP pump connection cable

CAUTION

The STP connection cable has the different specification according to the presence of a blue label. When operating the STP-A1603 series with the TMS unit using the STP connection cable without a blue label, the TMS unit does not operate (see Table 5).

STP connection cable	TMS unit	Available STP pump
With blue label	Not use	STP-603/1003 series STP-H301/H451 series STP-H803/H1303 series STP-A803/A1303 series STP-A1603 series
	Use	
Without blue label	Not use	STP-603/1003 series STP-H301/H451 series STP-H803/H1303 series STP-A803/A1303 series
	Use	

Table 5 - STP connection cable specification

SCU-800 Control Unit for Turbomolecular Pump

3.6.2 TMS connection cable

Connect the plug (pin) side of the TMS connection cable to the "TMS X5" of the TMS control unit.

The SCU-800 TMS unit is used with specified STP pumps. Refer to the STP pump Instruction Manual (B) for the cable connection method.

Note: Figure 15 shows a typical TMS cable. For details of the TMS cable used with the connected pump module, refer to the STP Pump Instruction Manual (B).

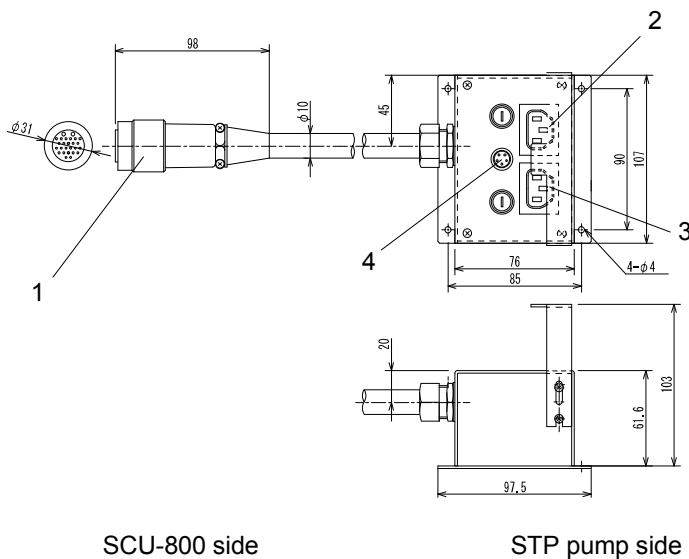

- | | | | |
|---|----------------------------|---|-----------------------------|
| 1 | SCU-800 connection | 3 | TMS heater cable connection |
| 2 | TMS valve cable connection | 4 | TMS sensor cable connection |

Figure 15 - TMS connection cable (standard)

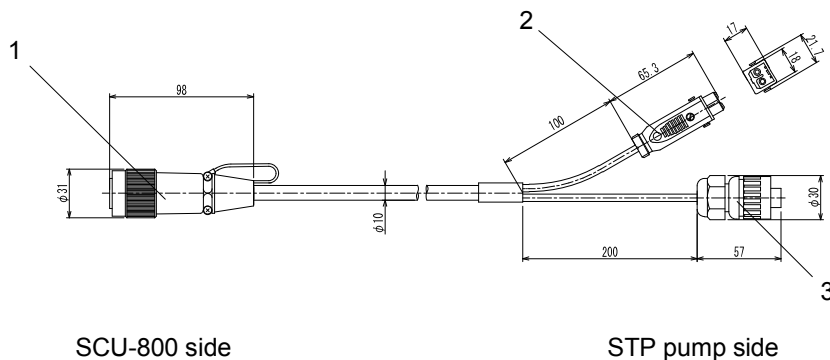

- | | | | |
|---|-----------------------------|---|----------------------------|
| 1 | SCU-800 connection | 3 | TMS valve cable connection |
| 2 | TMS heater cable connection | | |

Figure 16 - TMS connection cable (STP-A1603 series)

SCU-800 Control Unit for Turbomolecular Pump

3.6.3 Power cable



WARNING

Ensure that the SCU-800 and the electrical supply cable are suitably protected against earth (ground) faults and that the earth (ground) of the SCU-800 and "AC POWER X2" are correctly connected.

CAUTION

The power cable is designed specifically for the STP pump. DO NOT use the power cable with other products.

Connect the power cable securely to prevent any poor or cross connections. DO NOT apply voltages exceeding 1 kV to the input line.

Ensure that the supply voltage is as indicated on the SCU-800 information label. Connect the power cable to the "AC POWER X2" connector on the SCU-800.

Connect the power cable for the SCU-800 side to the "AC POWER X2" on the SCU-800 rear panel as shown in Table 6.

Connect the suitable connector to the power supply as shown in Table 6.

Connect the power cable to the main power of the vacuum equipment via a circuit breaker. Connect the primary power to the UL-recognized terminal block of the vacuum equipment. Secure the terminals with M4-bolts as the other side of the terminals, and cover the terminal block with an appropriate cover. (refer to Figure 18)

Note: The STP connection cable and primary power cable are not included. Contact the distributor to purchase.

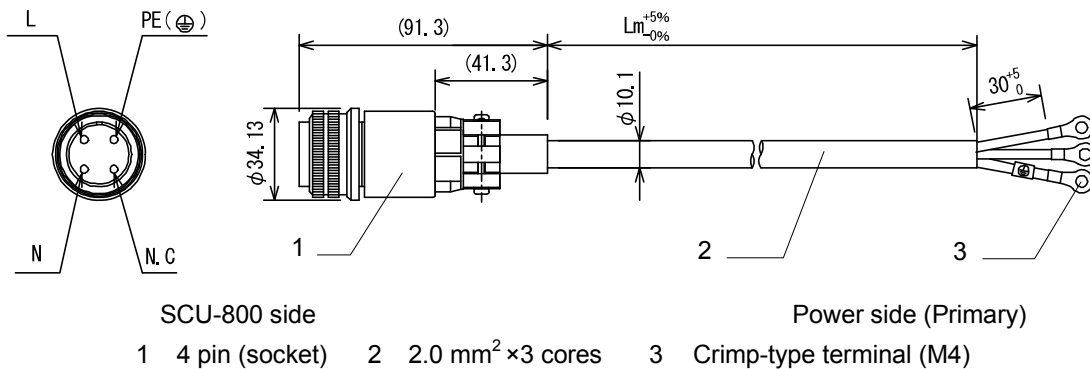
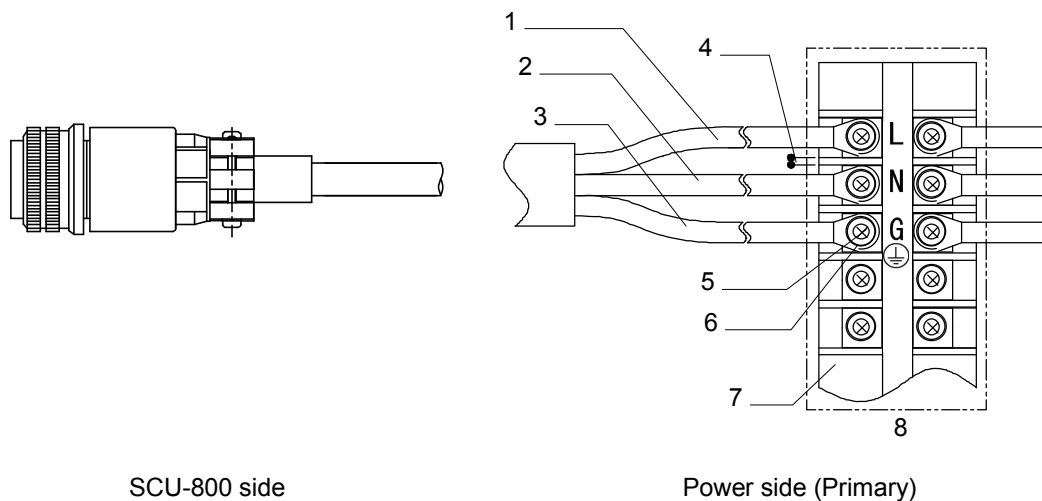

Figure 17 - Power cable

SCU-800 Control Unit for Turbomolecular Pump

CON1 pin	Cable Colour	Remarks
L	Black 1	Single-phase 200 to 240 Va.c. (200 V specification), 50/60 Hz, 6 A maximum, or Single-phase 100 to 120 Va.c. (100 V specification), 50/60 Hz, 12 A maximum
N	Black 2	
PE (⊕)	Yellow/Green	Earth (ground)
N.C	Unused	

Table 6 - Power cable



SCU-800 side

Power side (Primary)

- | | | | |
|---|-----------------------|---|------------------------------|
| 1 | Black1 | 5 | M4-bolt (fixing screw) |
| 2 | Black2 | 6 | Crimp-type terminal (M4) |
| 3 | Yellow/Green | 7 | Cover ^{*1} |
| 4 | Clearance min. 1.5 mm | 8 | Terminal block ^{*2} |

^{*1} Use material flammability: UL 94V-0

^{*2} Use the UL-recognized terminal block satisfying with the following conditions;

- Clearance (between each terminal): 1.5 mm or more
- Material flammability: UL 94V-0
- The installation category II.

Figure 18 - Connecting method of the power cable without plug

SCU-800 Control Unit for Turbomolecular Pump

3.7 Connecting to semiconductor equipment

The STP pump is a component system when installing to the semiconductor equipment. Consider the following when designing the semiconductor equipment.

3.7.1 Connecting to power

The SCU-800 receives its power from the semiconductor equipment electrical distribution system via a circuit breaker.

Electrical energy isolation (Lockout/Tagout) is achieved by opening the main disconnect device or circuit breaker of the semiconductor equipment, thereby removing power from the STP pump.

Provide the equipment with the main disconnect or circuit breaker devices rated for at least 10,000 A_{rms} symmetrical amperes interrupting capacity (AIC).

3.7.2 Emergency off circuit (EMO circuit)

Activation of EMO circuit of the equipment will interrupt electrical power from the SCU-800.

When the power is shut off, the STP pump performs the same as a power failure. (After backup operation of a power failure, the rotor lands on the touch down bearing)

Consider the following when establishing the EMO circuit.

CAUTION

Unite the exhaust gas system to prevent atmosphere from being introduced into the STP pump when the EMO circuit operates (example: shut the valve). When atmosphere is introduced into the STP pump, the touch down bearing may not operate normally.

CAUTION

The STP pump rotates for a while after the EMO circuit shuts off the power. Perform a recovery operation after the STP pump has stopped completely.

CAUTION

Before performing the operation check of the EMO circuit with regular maintenance, stop the STP pump to prevent damage to the touch down bearing.

*Note: Procure the main disconnect device and the EMO circuit at your company.
Use the main disconnect device which is lockable only in the de-energised position.
Locate the main disconnect device and the EMO button in the place where personnel are readily accessible and are not exposed to any hazards during operation.*

SCU-800 Control Unit for Turbomolecular Pump

3.8 Remote communication

3.8.1 Parallel communication

The SCU-800 is fitted with a remote communication port, "REMOTE X7" (refer to Figure 19) to allow remote input and output signal control via input and output remote signals. This connector is a D-Sub type (37-pins, socket) that conforms to MIL-C-24308. The screw for connector is M2.6.

Note: This D-Sub type connector is not supplied. Procure the connector for remote connection at your company.

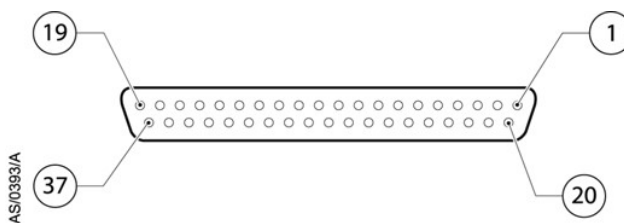

Figure 19 - REMOTE X7 connector

3.8.2 Serial communication

The SCU-800 is fitted with a remote communication port, "Connector X3A, X3B, X6" (refer to Figure 20) to allow remote input and output signal control by serial protocol. This connector is a D-Sub type (9-pins, socket) that conforms to MIL-C-24308. The screw for connector is M2.6.

Note: This D-Sub type connector is not supplied. Procure the connector for remote connection at your company.

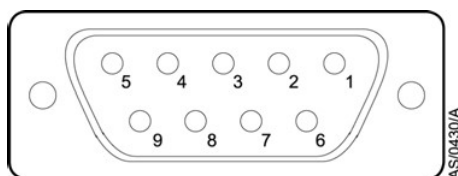

Figure 20 - Connector X3A, X3B, X6 (D-sub 9)

SCU-800 Control Unit for Turbomolecular Pump

3.9 Adjustment methods

3.9.1 Tuning

Tuning is required to align the position of levitation in the STP pump axial direction with the centre of the rotor's movable range. Tuning can be performed simply by pressing the "RESET" switch on the front panel. (refer to Figure 10)

Tuning is required in the following cases in which the position of levitation may deviate from the centre of the rotor's movable range:

- When purchasing only the SCU-800 and connecting to the STP pump for the first time.
- When changing the length of the STP connection cable (not when changing the length of the power cable).
- Connecting the same model but a different serial number of the STP pump to the SCU-800 after the tuning is performed. The error message "CAUTION : Coupling is Changed" is displayed upon performing the self test.
- Connecting a different model of the STP pump to the SCU-800 after the tuning is performed. The error message "CAUTION : Pump Type is Changed" is displayed upon performing the self test.

3.9.2 Tuning method

Refer to Figure 21.

1. Ensure all cables are connected.
2. Turn "ON" the MAIN POWER on the SCU-800 rear panel.
3. After the STP pump completes the self test and "Levitation" is displayed, set the MANUAL/REMOTE changeover switch to the MANUAL and press the "RESET" switch on the front panel for approximately 3 seconds.
4. See Section 4.2.2, "Tuning Method when "CAUTION" Message is Displayed after the Self Test" when a "CAUTION" message is displayed during the autotest.
5. When the LCD displays "Tuning", release the "RESET" switch. The tuning is performed automatically.
6. Approximately 1 minute later the LCD displays "Tuning Complete", and then displays "Levitation". This completes the tuning.

Note: Tuning can be performed only while the STP pump is in the LEVITATION state. (It cannot be performed while the STP pump is in the ACCELERATION, NORMAL OPERATION, or BRAKE state)

When performing the tuning during remote operation, press the "RESET" switch on the front panel after switching the "REMOTE" switch to MANUAL. (The remote signal cannot be used for tuning)

SCU-800 Control Unit for Turbomolecular Pump

Note: Once tuning is completed, re-tuning is not required unless the configuration (the STP pump serial number, the SCU-800 serial number, and the STP connection cable length) is changed.

Although the STP pump produces an abnormal noise during tuning, this is not an indication of abnormality.

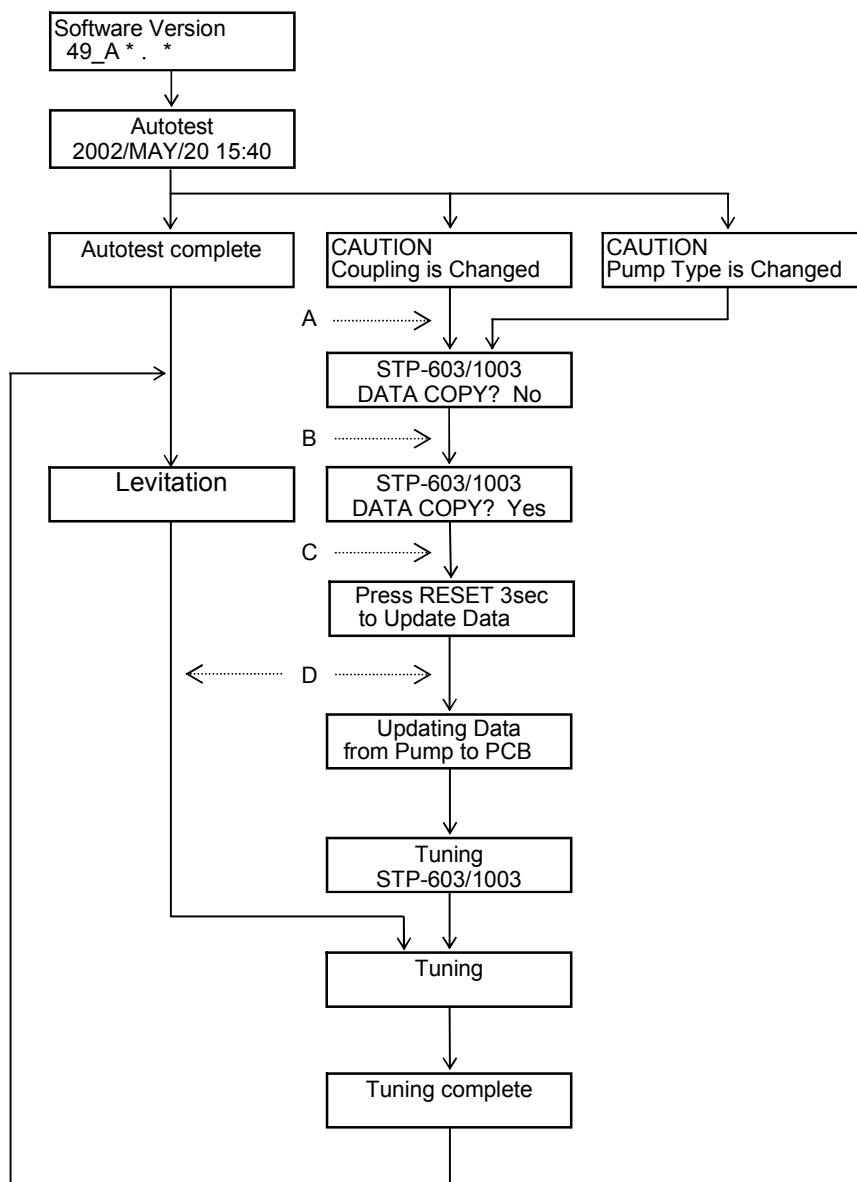

- A. Press "RESET" switch
- B. Press "UP" or "DOWN" switch
- C. Press "ENTER" switch
- D. Press "RESET" switch for approximately 3 seconds

Figure 21 - Tuning procedures

SCU-800 Control Unit for Turbomolecular Pump

3.9.3 Change of data after tuning

The user setting may be changed because of the change of the configuration of the STP pump and STP control unit after "CAUTION" message is displayed.

Confirm the setting shown in Table 7 after tuning, and reconfigure the setting when the user setting has changed.

For the setting confirmation, see Section 3.10, "Confirmation mode", for the setting method, see Section 3.11, "Parameter set mode".

Items	Factory setting (reference)	Remarks
Remote mode	I/O Remote	
Rotational speed	Rated speed	Varies according to STP pump type.
TMS function	DISABLE	ENABLE (in the case of the TMS specification).
Inhibit function	DISABLE	
Emergency vent valve	DISABLE	
Second damage limit	ENABLE	
Pump air-cooling fan	DISABLE	
Warning function	Damage point	ENABLE
	Imbalance	ENABLE
	Pump run time	DISABLE
	Pump overload	DISABLE
Serial port COM1, COM2	Baud rate	9600 bps
	Bit length	8
	Stop bit	1
	Parity	None
Serial port COM1 driver type	RS232	
Serial port COM2 driver type	RS485 Single	
Date/Time	Japan Standard Time	

Table 7 - User setting data list

SCU-800 Control Unit for Turbomolecular Pump

3.10 Confirmation mode

Confirmation mode is used to check the status of the STP pump and SCU-800. The following items can be checked in Confirmation mode:

1. Version information.
2. Individual information (serial number, total hours of running, number of starts and damage of the bearing).
3. Current settings (rotational speed, TMS temperature setting, actual pump temperature and actual motor current).
4. Current function settings (remote mode, TMS function, inhibit function, emergency vent valve, air cooling fan, rotational operation inhibit command, imbalance warning function, pump runtime warning function, and pump overload warning function).
5. Error record (The control unit can store information about up to 10 of the most recent errors. "1/n" denotes the most recent error. While pressing "ENTER" switch, the time of errors occurrence is displayed.)

3.10.1 Confirmation method

Refer to Figure 22.

1. Press the "SELECT" switch to enter the Confirmation mode.
The available menu groups (Section 3.10 steps (1) through (5)) are displayed in order.
2. Press the "UP" switch to display the next menu item. Press the "DOWN" switch to display the previous menu item.
3. Press the "SELECT" switch to display the next menu group.
4. Press the "UP" and "DOWN" switch to confirm the status of the items of the currently selected menu group.
5. Press the "SELECT" switch to return to Operation mode when viewing the Error Record.
If no switch is pressed for approximately 1 minute, the display will automatically revert to Operation mode.

SCU-800 Control Unit for Turbomolecular Pump

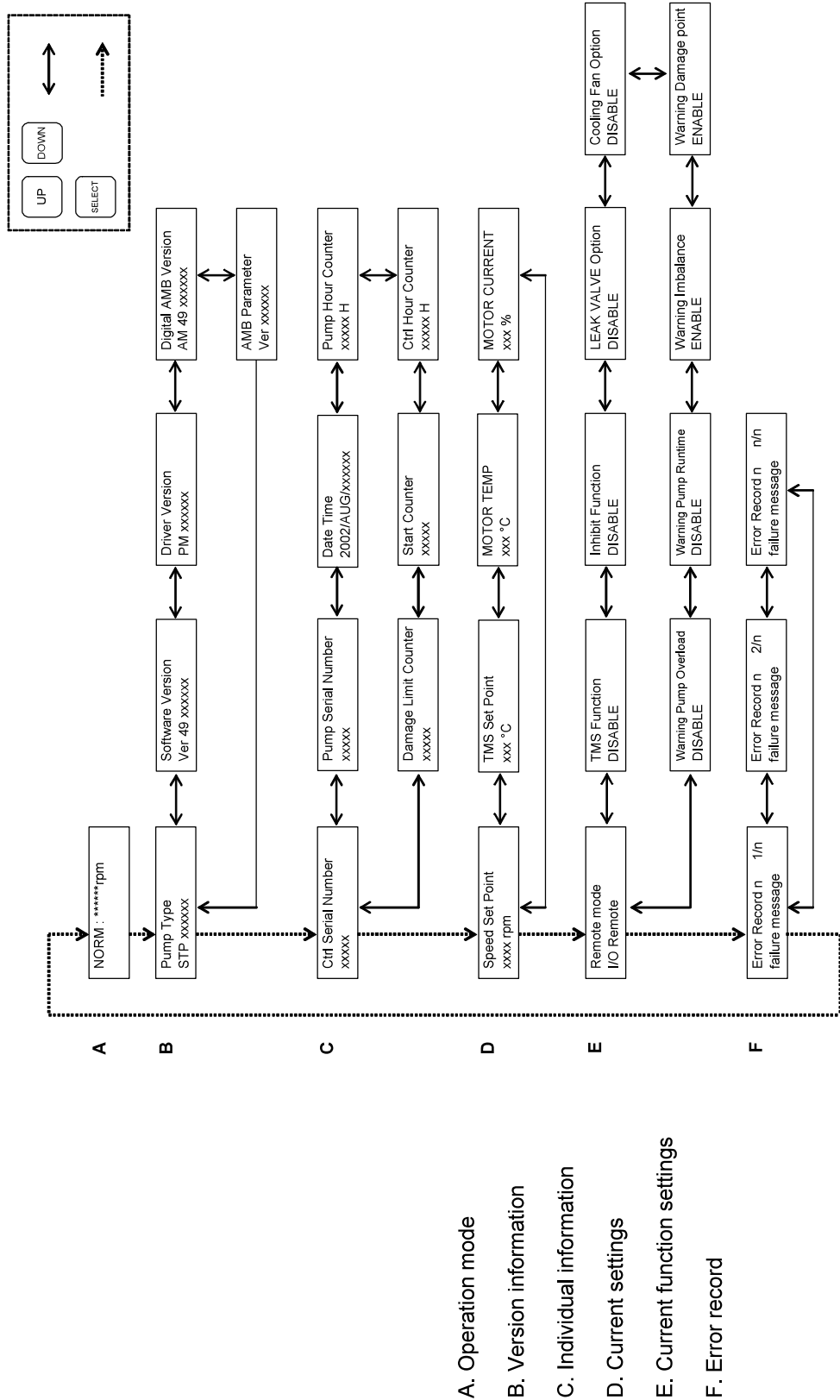

Figure 22 - Confirmation mode

SCU-800 Control Unit for Turbomolecular Pump

3.11 Parameter set mode

Parameter set mode is used to set the different parameters of the STP pump and SCU-800.

3.11.1 Remote operation setting

The remote parallel port (I/O REMOTE), serial port COM1, serial port COM2, and STP-Link are fitted on the SCU-800 as standard connectors for the remote operation. The hardware is selected for the remote operation setting of the start, stop and reset. Refer to Section 4.5, Section 5 and Section 6 for the remote operating methods. The remote output monitoring the operating state can be output with any hardware.

3.11.2 Rotational speed setting

The rotational speed can be changed in units of 500 rpm in the NORMAL state. The variable range is from half of the rated speed to the rated speed. The rated speed is different according to the connected pump.

3.11.3 TMS setting

Enable/Disable the TMS control function.

When the TMS control function is set to enable, the setting of the pump air-cooling fan output is disabled automatically.

3.11.4 Rotational inhibit signal setting

Enable/Disable the rotation inhibit signal.

3.11.5 Emergency vent valve setting

Enable/Disable the emergency vent valve function. When a failure of the magnetic bearing is detected, in the state of effective, 24 DCV is output between the TMS connector X5-19 pin and 20 pin. Disable the function when the emergency vent valve is not fitted on the STP pump connected to the SCU-800.

SCU-800 Control Unit for Turbomolecular Pump

3.11.6 Second Damage Limit setting

Enable/Disable the rotational operation after "Second Damage Limit" occurs. When setting to "ENABLE", "START NOT ALLOWED" is displayed and the rotational operation cannot be performed. When setting to "DISABLE", "Second Damage Limit" is displayed, though the rotational operation can be performed.

3.11.7 Pump air-cooling fan output setting

When the output voltage of the air-cooling fan of the STP pump in the "ACCEL" state or "NORMAL" state, the input power supply voltage is output to the output terminal of the TMS connector X5. The air-cooling fan can be used as a replacement of the TMS heater.
When the air-cooling fan of the pump is set to enable, the TMS function is set to disable automatically.

SCU-800 Control Unit for Turbomolecular Pump

3.11.8 Warning function setting

Refer to Section 7.2, "WARNING Message Function" for the detail of the "WARNING" function.

1. Warning Damage Point

Enable/Disable Damage limit of the bearing warning function.

When setting to "ENABLE" and the Damage limit of the bearing exceeds the setting value, a warning message is displayed.

2. Warning Imbalance

Enable/Disable Imbalance warning function.

When setting to "ENABLE" and the Imbalance of the rotor exceeds the setting value, a warning message is displayed.

3. Warning Pump Runtime

Enable/Disable warning function of the pump operation hours.

When setting to "ENABLE" and the operating hours exceeds the setting value, the warning message is displayed.

4. Pump Runtime Set Point

Enable/Disable warning function of the pump operating hours in units of 100 hours. (up to 30 million hours)

5. Warning Pump Overload

Enable/Disable overload warning function of the pump.

When setting "ENABLE" and the state for the motor current of the STP pump continues exceeding or dropping below the setting value, the warning message is displayed.

6. Current Ceiling Rate

Sets the motor current of the overload warning function of the pump.

The rated speed (max. current) is as 100%. It can be set from 0 to 100 %. The smaller current setting value is given "WARNING" because the warning occurs when the pump overloads and the motor current exceeds the setting value.

7. Speed Floor Rate

Sets the rotational speed of the overload warning function of the pump.

The rated speed is as 100%. It can be set from 0 to 100 %. The bigger rated rotational speed setting value is given "WARNING" because the warning occurs when the pump overloads and the rated speed drops below the setting value in NORMAL state.

SCU-800 Control Unit for Turbomolecular Pump

3.11.9 Serial port COM1 setting

1. Baud rate
Set the communication speed. Maximum 56,000 bps can be set.
2. Bit length
Set the bit number of the communication data to 7 or 8.
3. Stop bit
Set the stop bits number to 1 or 2.
4. Parity
Presence or absence of parity check. In the case of presence, select even number or odd number.
5. Driver type
Set to either the RS232, RS485 (Single) or RS485 (Multi).
6. RS485ID
Set the identification number in the RS485 (Multi). (1 to 127).

3.11.10 Serial port COM2 setting

Refer to 1 to 4, and 6.

5. Driver type
Set the one of the RS485 (Single) or RS485 (Multi).

3.11.11 Serial port COM3 setting

An optionally available serial port.

3.11.12 Date/Time setting

Set the present date/time in the built-in clock.

3.11.13 Factory setting

The set value of the factory setting is shown in Table 7.

SCU-800 Control Unit for Turbomolecular Pump

3.11.14 Parameter setting procedure

Refer to Figure 23 to Figure 26.

1. Press the "UP" and "SELECT" switches simultaneously to enter the Parameter Set Mode. The setting options detailed from Section 3.11.1 to 3.11.12 is each displayed in order.
2. Press the "UP" switch to go to the next parameter, and press the "DOWN" switch to display the previous parameter.
3. Press the "ENTER" switch to set the new parameter and to enter the next menu. However, note that the new parameter is not accepted until it is stored (refer to step 6 below).
4. When the parameter is not required to be set, press the "SELECT" switch and go to the next menu.
5. Use the same procedure 1 to 4 above to set the remaining parameters.
6. "STORAGE NO" is displayed on the preservation menu. Select "YES" with the "UP" or "DOWN" switches and press "ENTER" to store the parameter. The message on the LCD displays "STORAGE IN PROGRESS" shown the storage state. Then the storage succeeds, "STORAGE OK" is displayed. However the storage fails, "STORAGE NOT OK" is displayed.
7. When pressing the "SELECT" switch in the state of "STORAGE NOT OK" displayed, the preservation is displayed. In this case, try to store it again.
8. Press the "SELECT" switch when the state "STORAGE OK" is displayed to enter the date/time setting menu. It is displayed as "2002/AUG/08 11 : 08 ENTER to adjust" on the LCD. Press "ENTER" switch to enter to the year setting menu. If you do not want to set the date, press the "SERECT" switch, and return to the operation mode.
9. The year can be changed with "UP" or "DOWN" switch. Press the "SELECT" or "ENTER" switch to enter the month setting menu. However, note that the change of year is not accepted yet.
10. Display the date, hour and the minute with the "SELECT" or "ENTER" switch. Set them with "UP" or "DOWN" switch.
11. The date/time and "ENTER to Cancel" are displayed on the confirmation menu. If you have made an error when setting, press the "ENTER" switch to return to the date/time setting menu in 8).
12. After confirming the date/time on the confirmation menu, select the "apply" and then press the "ENTER" switch.

Note: If no switch is pressed for approximately 1 minute, the display will automatically revert to Operation mode. In this case, unsaved settings are not changed.

SCU-800 Control Unit for Turbomolecular Pump

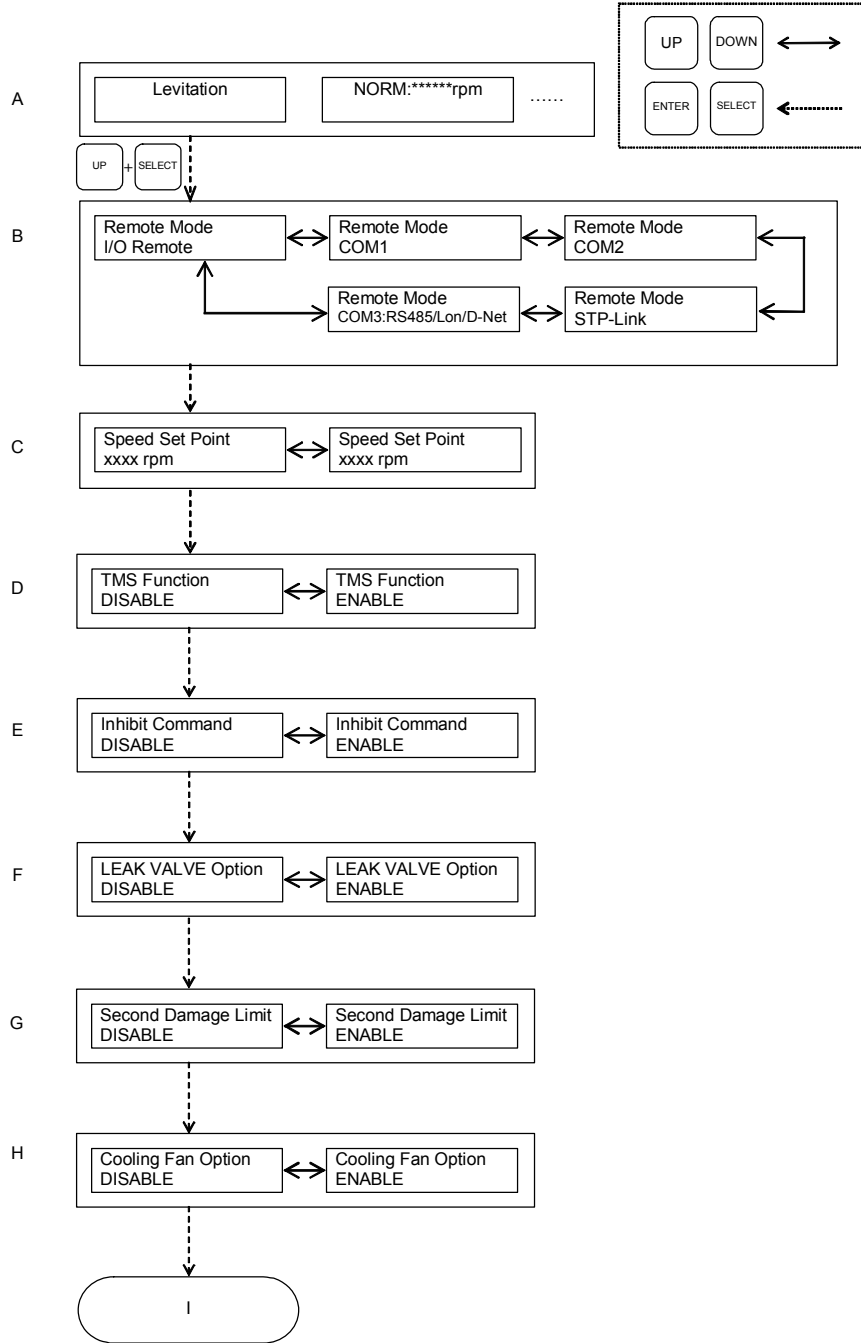

Figure 23 - Parameter setting method

- | | |
|-----------------------------|---------------------------------|
| A. Operation mode | F. Emergency vent valve setting |
| B. Select remote mode | G. Second Damage Limit setting |
| C. Rated speed setting | H. Cooling fan setting |
| D. TMS function setting | I. To Warning function setting |
| E. INHIBIT function setting | |

SCU-800 Control Unit for Turbomolecular Pump

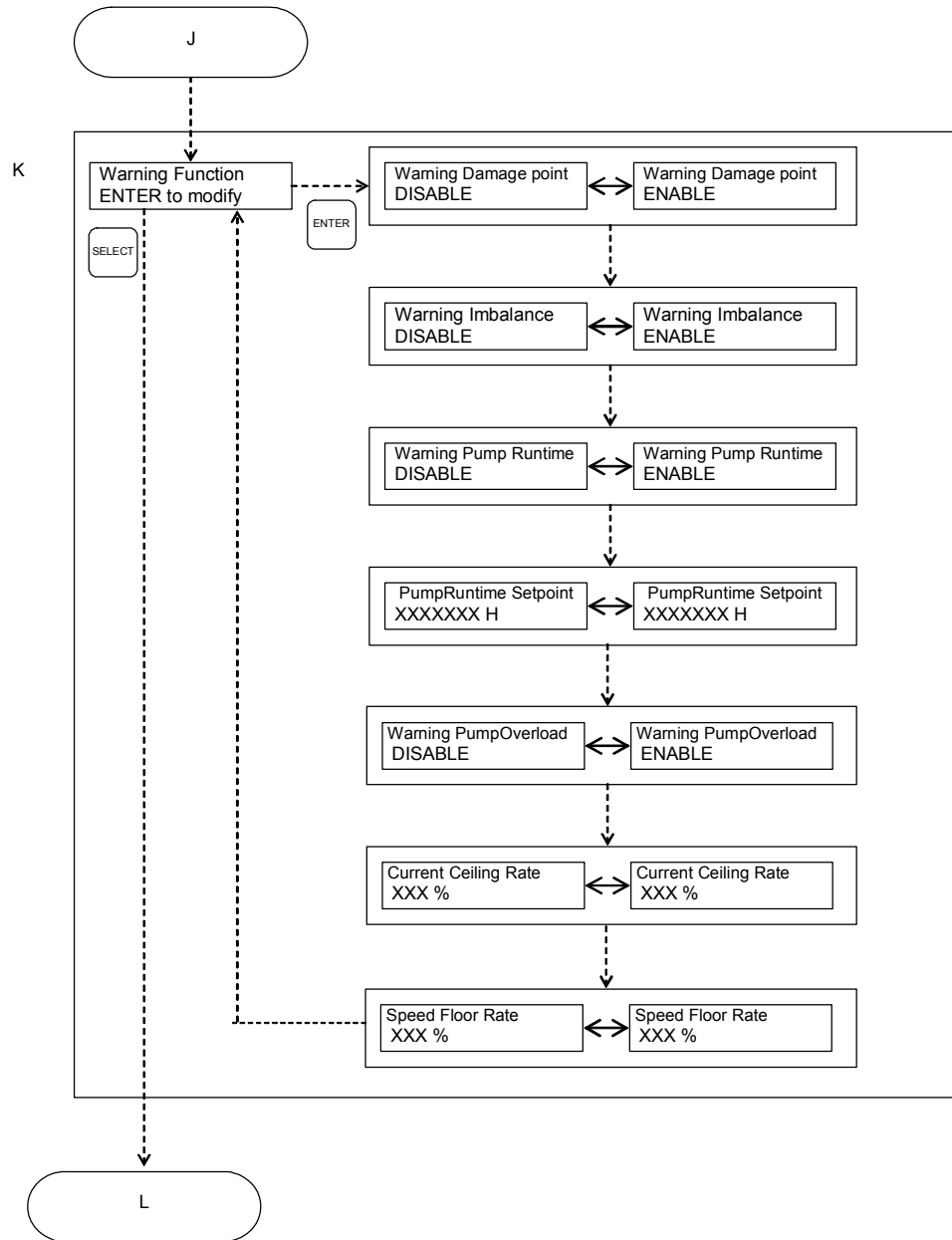

Figure 24 - Parameter setting method (continued)

- J. From Cooling fan setting
- K. Warning function setting
- L. To Serial port COM1 setting

SCU-800 Control Unit for Turbomolecular Pump

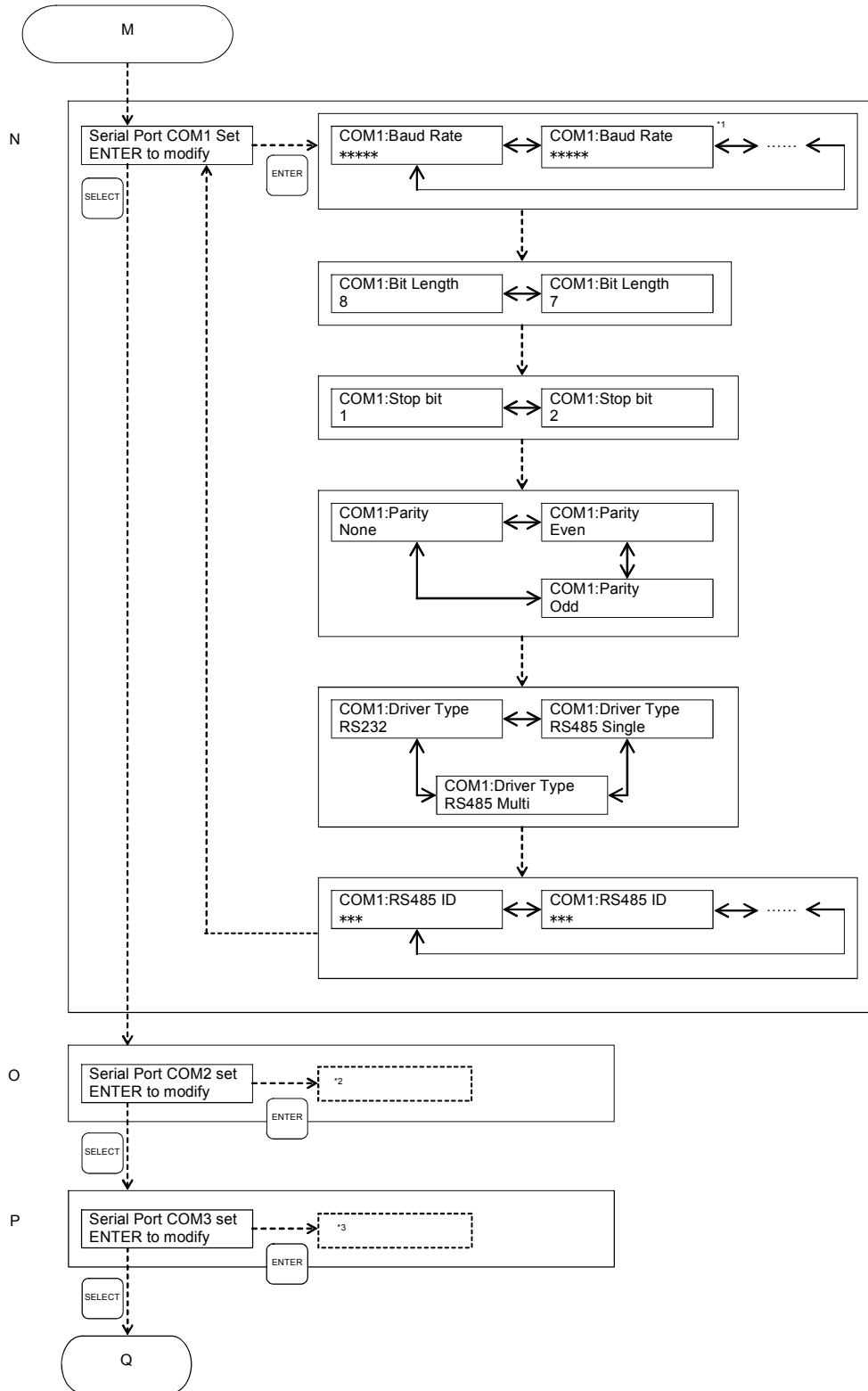

Figure 25 - Parameter setting method (continued)

SCU-800 Control Unit for Turbomolecular Pump

- ^{*1} Available "Baud Rate" are 110, 300, 600, 1200, 2400, 4800, 9600, 14400, 19200, 28800, 38400, and 56000 bps. Available "RS485ID" is between 1 and 127.
- ^{*2} The Serial Port COM2 setting menu composition is the same as the Serial Port COM1 setting. Only "RS485 (Single)" and "RS485 (Multi)" are selectable to Driver Type.
- ^{*3} The Serial Port COM3 setting menu composition is the same as the Serial Port COM1 setting. "Lon" and "D-Net" are added to Driver Type. The Serial Port COM3 cannot be set without the option board.

- M. From Warning function setting
- N. Serial port COM1 setting
- O. Serial port COM2 setting
- P. Serial port COM3 setting
- Q. To Storing display

SCU-800 Control Unit for Turbomolecular Pump

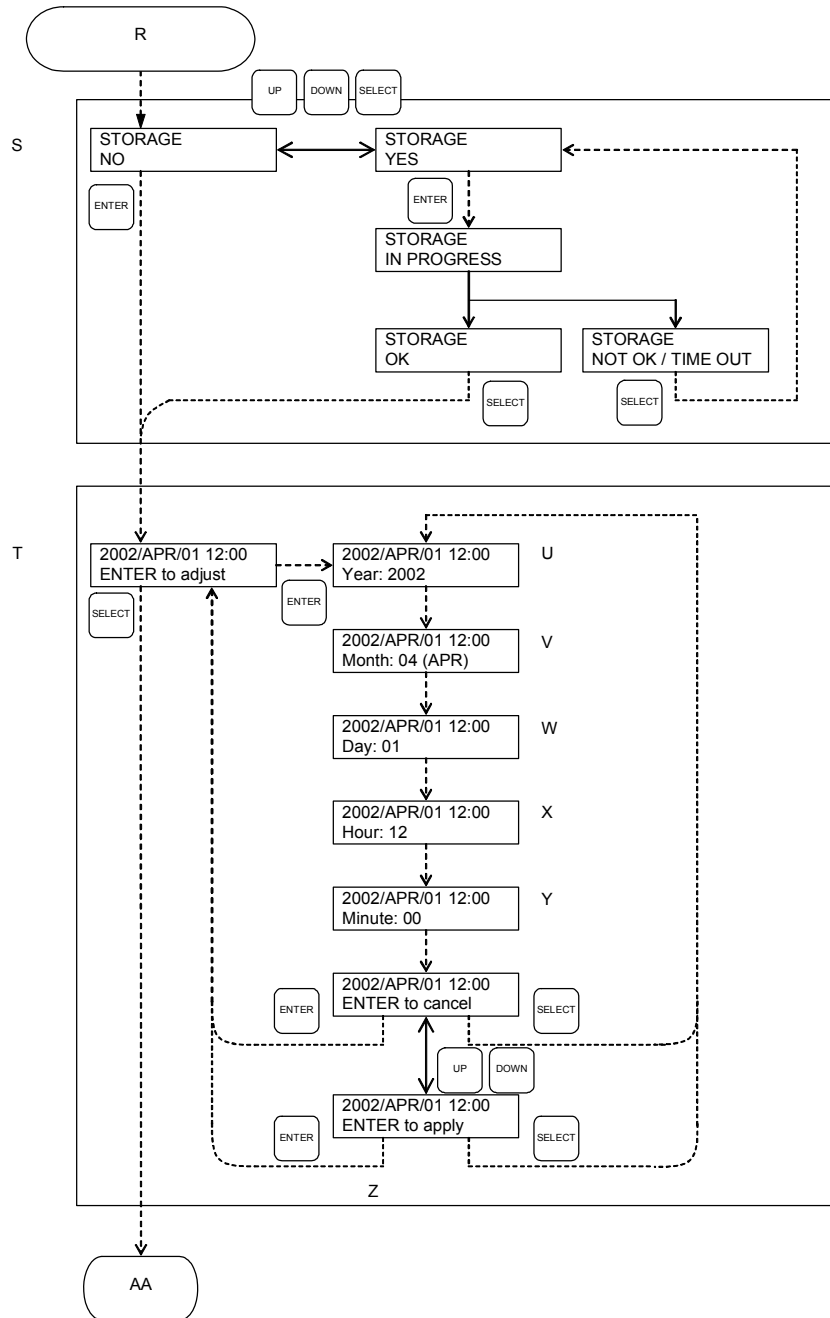

Figure 26 - Parameter setting method (continued)

- | | |
|------------------------------------|---|
| R. From Serial port COM3 setting | W. Press "UP/DOWN" to change Day |
| S. Storing display | X. Press "UP/DOWN" to change Hour |
| T. Date/Time setting display | Y. Press "UP/DOWN" to change Minute |
| U. Press "UP/DOWN" to change Year | Z. Press "ENTER" to set Date/Time setting |
| V. Press "UP/DOWN" to change Month | AA. To Operation mode display |

SCU-800 Control Unit for Turbomolecular Pump

3.12 Manual operation mode

The operation of the TMS heater, TMS water valve, pump air-cooling fan, and the emergency vent valve can be inspected in manual operation mode. However, the manual operation cannot be performed in the remote operation or using different TMS voltage.

1. Press the "DOWN" and "SELECT" switches simultaneously to enter Manual Mode, then "Manual Operation TMS Heater OFF" is displayed.
2. Press "UP" switch to display "TMS Heater ON", and the TMS Heater output turns "ON". Press "DOWN" switch to display "TMS Heater OFF", and the TMS Heater output turns "OFF".
3. Press "SELECT" switch to display "TMS Water Valve Close", and the TMS water valve can be operated manually with "UP" and "DOWN" switches.
4. Press "SELECT" switch to display "Cooling Fan OFF", "Leak Valve Close".
5. Press "SELECT" switch in the Emergency vent valve operation to return to the Operation Mode.

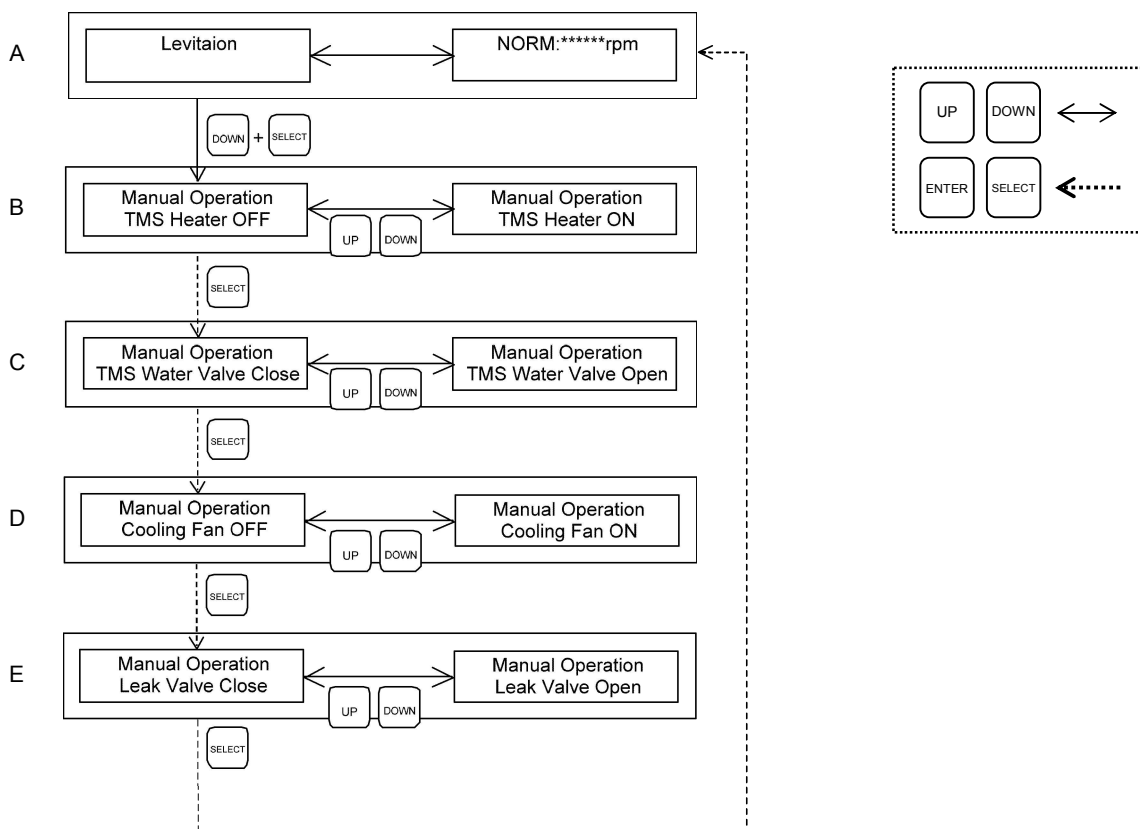

Figure 27 - Manual operation method

- | | |
|--------------------|-------------------------|
| A. Operation mode | D. Air-cooling fan |
| B. TMS heater | E. Emergency vent valve |
| C. TMS water valve | |

4 OPERATION

4.1 Before starting the STP pump

CAUTION

NEVER connect or disconnect any cables while the power is ON. NEVER turn the primary power OFF (turn the MAIN POWER "OFF") while the STP pump is in rotation. DO NOT release the inlet port flange or outlet port flange into the atmosphere while the STP pump is rotating

4.1.1 Confirmation before starting

After completing the installation of the STP pump and the SCU-800, carry out the following checks before starting:

1. Ensure the STP pump and the SCU-800 are installed correctly (refer to Section 3).
2. Ensure the correct supply voltage is applied.
3. Ensure all cables are securely connected and locked.
4. Ensure the length of the STP connection cable. If it is changed, perform the tuning according to Section 3.9.1, "Tuning".

4.1.2 Confirmation of vacuum system

1. Starting backing-pump

Start the backing-pump before or simultaneously with the start of the STP pump. Open the vacuum valve located at the outlet port flange side after starting the backing-pump.

Note: DO NOT open the vacuum valve without operating the backing-pump. Depending upon the type of the backing-pump, doing so may cause a reverse flow of oil, which could contaminate the inside of the STP pump.

2. Stop backing-pump

CAUTION

DO NOT stop the backing-pump without closing the vacuum valve. Depending upon the type of the backing-pump, doing so could cause a reverse flow of atmospheric air into the STP pump, which may result in a malfunction.

Close the vacuum valve located at the outlet port flange side just before or after stopping the STP pump. After closing the valve, stop the backing-pump.

Note: DO NOT stop the backing-pump without closing the vacuum valve. Depending upon the type of the backing-pump, doing so could cause a reverse flow of oil, which could contaminate the inside of the pump.

SCU-800 Control Unit for Turbomolecular Pump

4.2 Powering ON

4.2.1 Self test

Refer to Figure 28.

1. Switch the MAIN POWER to "ON", located on the SCU-800 rear panel, refer to Figure 10. (To prevent incorrect operation, a metal fitting is attached to the breaker. Loosen the screw, lift the metal fitting and secure it.) The SCU-800 performs a self test and "Autotest" is displayed on the LCD.
2. If no error is found, the LCD displays "Autotest complete" and the magnetic bearing is turned "ON". When the rotor levitates normally, the LCD displays "Levitation" and the STP pump can be operated.

4.2.2 "CAUTION" message in the self test state

When the configuration (the STP pump serial number or the SCU-800) is changed, a "CAUTION" message is displayed on the LCD during the self test. Refer to Table 33 when "CAUTION" is other than those in Table 8.

CAUTION message	Causes
Coupling is Changed	Connecting the same model but the different serial number of the STP pump to the SCU-800 after the tuning is performed.
Pump Type is Changed	Connecting the different model of the STP pump to the SCU-800 after the tuning is performed.
Pump Type is Mismatch	Using the different series of the STP pump with the SCU-800. Use the specific control unit.

Table 8 - Causes of "CAUTION" at the self test state

Perform as follows when "CAUTION : Coupling is Changed" or "CAUTION : Pump Type is Changed" is displayed.

1. When pressing the "RESET" switch, the LCD displays the model name of the STP pump currently connected and the confirmation message to copy the data of the STP pump onto the SCU-800.
Example: "STP-A803/A1303", "DATA COPY? No"
2. When the exact model name is displayed, press the "UP" or "DOWN" switch. "DATA COPY? Yes" is displayed on the LCD. In the case of the LCD displays an unexpected model name of the STP pump, turn the breaker "OFF." After checking the configuration, re-start the STP pump.
3. Press the "ENTER" switch in the state of "DATA COPY? Yes" on the LCD. "Press RESET 3 sec to Update Data" is displayed on the LCD.
4. Press the "RESET" switch 3 sec. or more. "Updating data from Pump to PCB" is displayed for a few second, and then "Tuning" is displayed, the tuning is performed automatically.

SCU-800 Control Unit for Turbomolecular Pump

5. After completing the tuning, "Levitation" is displayed on the LCD and the rotating operation of the STP pump can be started.

See Section 7, "MAINTENANCE", when an abnormality/error occurs other than above during the tuning.

4.3 How to start/stop the STP pump

There are two methods of operating the STP pump; MANUAL and REMOTE. Select one which suits your vacuum equipment.

4.4 Manual start/stop the STP pump

To manually start/stop the STP pump, slide the "MANUAL/REMOTE" changeover switch on the SCU-800 front panel from the "ON" position, refer to Figure 9. The "REMOTE" LED will extinguish.

4.4.1 Starting the STP pump

1. Press the "START" switch on the front panel to start, refer to Figure 9 and accelerate the STP pump. The "ACCEL." LED illuminates. The LCD displays the current rotational speed in "ACCEL: ***00rpm" in 500 rpm intervals (ACCELERATION state).
2. When the STP pump attains the rated speed of rotation, the "ACCEL." LED extinguishes, and the "NORMAL" LED illuminates. The LCD displays "NORM: ***00rpm". (NORMAL OPERATION state)

4.4.2 Stopping the STP pump

1. Press the "STOP" switch on the front panel to stop the STP pump.
2. The "NORMAL" LED or "ACCEL." LED extinguishes, and the "BRAKE" LED illuminates (BRAKE state).
3. When the rotational speed decreases to 500 rpm or less, the "BRAKE" LED extinguishes.

4.4.3 Starting the STP pump after stopping

1. Press the "START" switch on the front panel to accelerate the STP pump.
2. The STP pump can be accelerated even while it is stopping.

Note: Avoid frequent start/stop operations as this may cause the STP pump to overheat.

SCU-800 Control Unit for Turbomolecular Pump

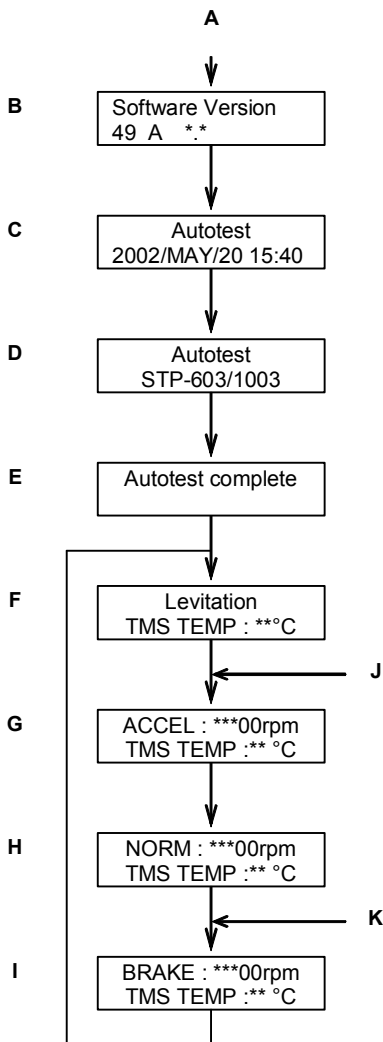

Figure 28 - Operational procedures

- | | | |
|--|--|--|
| A. MAIN POWER "ON" | E. Self test completed
(upper only) | H. Normal Operation State
Upper: Normal operation state
Lower: TMS actual temp
(for only with TMS unit) |
| B. Version | F. Levitation State
Upper: Levitation state
Lower: TMS actual temp
(for only with TMS unit) | I. Break State
Upper: Brake state
Lower: TMS actual temp
(for only with TMS unit) |
| C. Self test
Upper: Autotest
Lower: Date | G. Acceleration State
Upper: Acceleration state
Lower: TMS actual temp
(for only with TMS unit) | J. Start operation of the STP pump |
| D. Self test
Upper: Autotest
Lower: Model of
connected pump | K. Stop operation of the STP pump | |

SCU-800 Control Unit for Turbomolecular Pump

4.5 Remote operation

To select remote operation, slide the "MANUAL/REMOTE" changeover switch on the SCU-800 front panel to "ON", refer to Figure 9. The "REMOTE" LED illuminates.

4.5.1 Input signal pins

Use input signal pins according to Table 9 and Figure 29. Remote input signals are set to the parallel port in the remote setting and function during REMOTE operation only, expect pins for inputting the ROTATION INHIBIT.

Two abbreviations are used in Table 9 and Figure 29:

COM: Common Pin

IN: Input Pin

SCU-800 Control Unit for Turbomolecular Pump



Pin	Description
	<p>Pins for inputting the START signal. The following two methods are available:</p> <ol style="list-style-type: none"> Short the circuits between (1)-(21). Then, short the circuits between (3)-(21) for 0.3 seconds or more. However, when inputting this START signal simultaneously with switching "ON" the breaker on the rear panel, continue to short these pins for 10 seconds or more. Short the circuits between (1)-(3). In this case, (21) is not used.
	<p>Pins for inputting the STOP signal.</p> <ol style="list-style-type: none"> When 1) above is used to start the STP pump, open the circuits between (1)-(21) to stop the STP pump. When 2) above is used to start the STP pump, open the circuits between (1)-(3) to stop the STP pump.
	<p>Pins for inputting the abnormality RESET signal.</p> <p>When a safety function operates, remove the cause of the abnormality/error after confirming the STP pump has stopped. When the cause of the abnormality/error is removed, short the circuits between (1)-(22) for 0.3 seconds or more to extinguish the "FAILURE" LED.</p>
	<p>Pins for inputting the rotation INHIBIT signal (valid in both MANUAL and REMOTE operations).</p> <p>When pins (1)-(5) are set to open, the STP pump does not rotate even by performing the start operation. (The pump does not rotate even by manually starting the pump) When these pins are set to open while the pump is in rotation, the pump will stop.</p> <p>When the INHIBIT signal is release, the pump restarts.</p> <p>When not using this function, set the rotation INHIBIT signal function to the "DISABLE" (see Section 3.11, "Parameter set mode").</p>
<p>(2), (19), (20), (31), (34)</p>	<p>These pins are not used.</p> <p style="text-align: center;">CAUTION</p> <p>DO NOT connect anything to these pins. Doing so may damage the SCU-800 or the vacuum equipment.</p>

Table 9 - REMOTE X7 input signal pins

SCU-800 Control Unit for Turbomolecular Pump

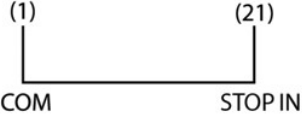

- | | | |
|------------------------|--------------------------------------|----------------|
| A. In case of Start 1) | D. Rotation INHIBIT signal | G. Unused pins |
| B. In case of Start 2) | E. Option signal input pins (unused) | |
| C. RESET signal | F. Option signal input pins (unused) | |

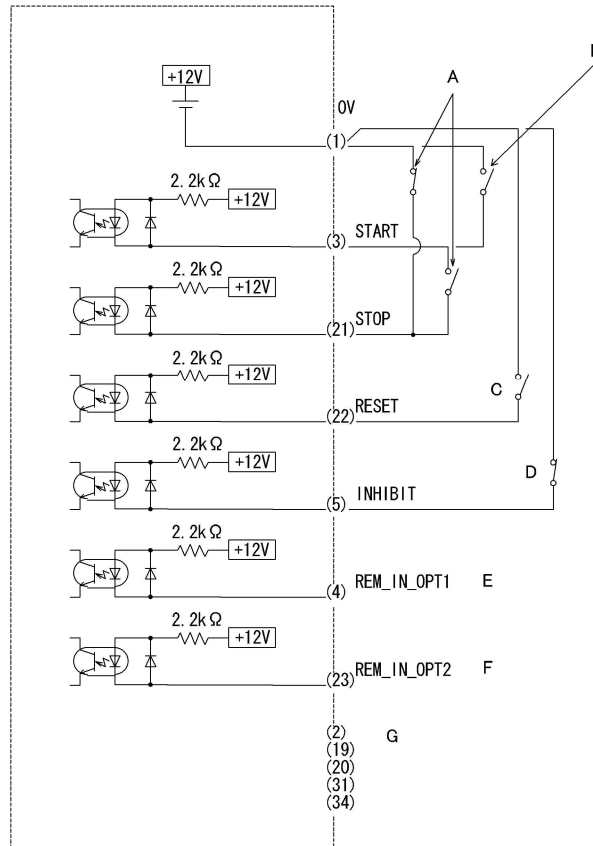
Figure 29 - REMOTE X7 input signal pins

Note: 1 pin (0V) is insulated from the frame ground.

Note: The input current of remote input signal is approximately 5mA. Make sure the minimum applicable load of the relay contact when the remote operation with the relay.

Note: It is recommended to use a remote cable with shield type, and connect both terminals to the ground.

4.5.2 Output signal pins

Use output signal pins according to Table 10 and Figure 30. Remote output signals function during MANUAL and REMOTE operations. Three abbreviations are used in Table 10 and Figure 30.

N.O OUT: Normal Open Output Pin
 N.C OUT: Normal Close Output Pin
 COM: Common Pin

SCU-800 Control Unit for Turbomolecular Pump





Pin	Description
	<p>Pins for outputting the STP pump REMOTE SELECTION state signal. When the MANUAL/REMOTE changeover switch on the front panel is set to ON (remote side), these pins are closed ("REMOTE" operation).</p>
	<p>Pins for outputting the POWER ON state signal. These pins are closed when magnetic bearing functions and the rotor levitates. This output is opened at a power failure.</p>
	<p>Pins for outputting the ACCELERATION state signal. These pins are closed when the STP pump is in acceleration.</p>
	<p>Pins for outputting the NORMAL OPERATION state signal. When the STP pump is in rated operation, the pins between (11)-(30) are closed, and the pins between (12)-(30) are opened.</p>
	<p>Pins for outputting the BRAKE state signal. These pins are closed when the STP pump is in brake.</p>
	<p>Pins for outputting the ALARM signal. When an abnormality/error is detected under the POWER ON state, the pins between (14)-(33) are closed, and the pins between (15)-(33) are opened.</p>
	<p>Pins for the TMS unit rated state signal output. When the actual temperature of the TMS unit is within the setting temperature range $\pm 10^{\circ}\text{C}$, the pins between (16)-(17) are closed and the pins between (35)-(17) are opened.</p>
	<p>Pins for the WARNING signal output. When the WARNING message is displayed on the LCD, the pins between (24)-(6) are closed and the pins between (25)-(6) are opened.</p>
	<p>Pins for the emergency vent valve operation signal (optional accessory). These pins are closed while this valve functions.</p>

Table 10 - REMOTE X7 output signal pins

SCU-800 Control Unit for Turbomolecular Pump

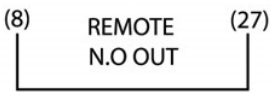
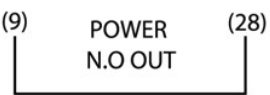
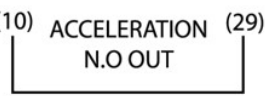
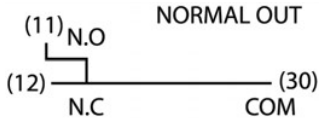

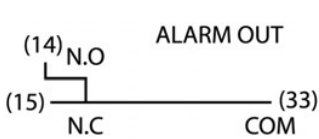
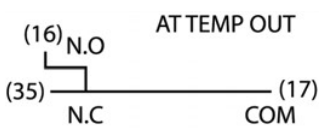
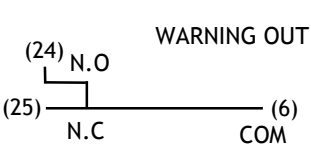
- | | | |
|---|---|--|
| A. REMOTE selection state
signal output pins | E. BRAKE state
signal output pins | H. WARNING state
signal output pins |
| B. POWER ON state
signal output pins | F. ALARM state
signal output pins | I. Emergency vent valve open
signal output pins |
| C. ACCELERATION state
signal output pins | G. TMS unit rated state
signal output pins | J. OPTION signal output pin
(unused) |
| D. NORMAL OPERATION state
signal output pins | | |

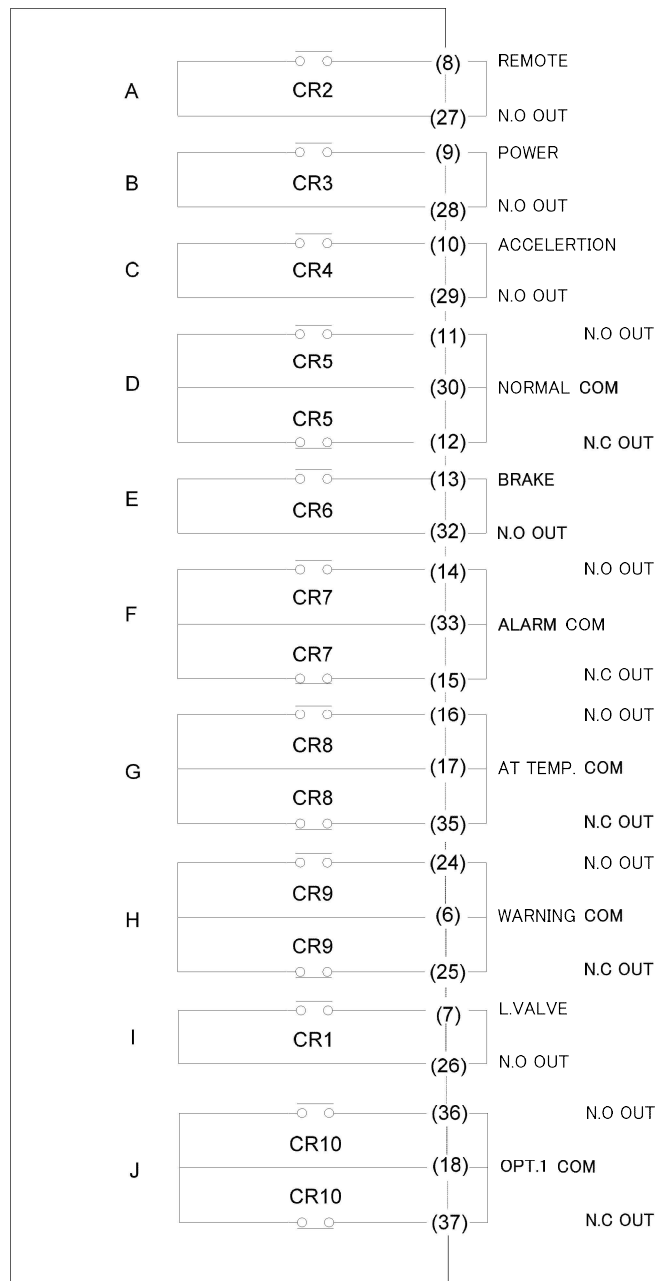
Figure 30 - REMOTE X7 output signal pins

SCU-800 Control Unit for Turbomolecular Pump

Table 11 shows the rated contacts for relays CR1 to CR10 in Figure 30.

	Resistance Load (COS Ø=1)
Rated Load	125 VAC, 0.5 A 24 VDC, 1 A
Rated Current	2 A
Maximum Contact Point Current	1 A
Maximum Open/Close Capacity	AC: 62.5 VA DC: 30 W
Minimum Applicable Load	5 VDC, 1 mA

Table 11 - Rated contacts for relays CR1 to CR10

4.5.3 Remote setting

The parallel port (REMOTE X7) and serial port COM1 (REMOTE X3A/X3B), serial port COM2 (REMOTE X6) and STP-Link (X8) are fitted as standard. The network terminal such as the Lon or the Devicenet is available as options.

It is necessary to set the hardware for the remote operation first. See Section 3.11, "Setting Mode" for information and methods.

This section details the operating method using the parallel port (REMOTE X7), refer to Figure 20, "X7 REMOTE connector" for details of pin location. For the operating method using the serial port, refer to Section 5 and Section 7.

4.5.4 Starting/Stopping the STP pump

There are two methods for the starting/stopping operation with the parallel port (REMOTE X7). Use one of them.

Method	Starting the pump	Stopping the pump
1	1) Short the circuit between (1)-(21). 2) Short the circuit between (3)-(21) for 0.3 seconds or more. However, when inputting this signal simultaneously with switching "ON" the breaker on the rear panel, short the circuit between (3)-(21) for 10 seconds or more.	Open the circuit between (1)-(21).
2	Short the circuit between (1)-(3). In this case, (21) is not used.	Open the circuit between (1)-(3).

Table 12 - Starting/Stopping the STP pump during remote operation (REMOTE X7)

SCU-800 Control Unit for Turbomolecular Pump

4.6 Rotation INHIBIT signal

When using rotation INHIBIT signal, set the rotation INHIBIT function to the "ENALBE" according to Section 3.11, "Parameter set mode". Relations between rotation INHIBIT signal input and pump operation state are shown in Table 13.

Signal input	Pump operation
<p>After short-circuit of rotation INHIBIT input signal (A), the START operation is performed (B).</p> 	<p><MANUAL/REMOTE operation mode></p> <ul style="list-style-type: none"> • The pump accelerates when the START operation is performed (B).
<p>After the START operation (A), the rotation INHIBIT input signal is short-circuited (B).</p> 	<p>< MANUAL operation mode ></p> <ul style="list-style-type: none"> • The pump does not accelerate. <p>< REMOTE operation mode ></p> <ul style="list-style-type: none"> • The pump does not accelerate when the START operation is performed (A). • The pump accelerates when the rotation INHIBIT input signal is short-circuited (B).
<p>The rotation INHIBIT input signal is opened (A) during acceleration or normal operation.</p> 	<p>< MANUAL/REMOTE operation mode ></p> <ul style="list-style-type: none"> • The pump decelerates and stops when the rotation INHIBIT input signal is opened (A). • After the operation (A), the pump continues deceleration and stops even by short-circuiting the rotation INHIBIT input signal (B). However, when the START signal is input, the pump will accelerate.

Table 13 - Rotation INHIBIT signal input

SCU-800 Control Unit for Turbomolecular Pump

4.6.1 Starting the STP pump after stopping

Perform the start operation to accelerate the STP pump. Refer to Section 4.5.4. The STP pump can be accelerated even while it is stopping.

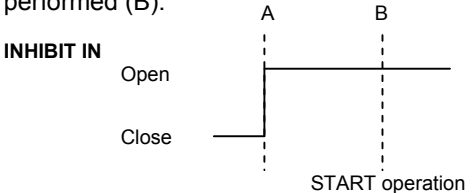
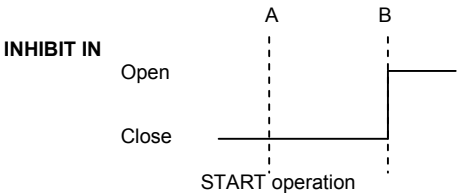
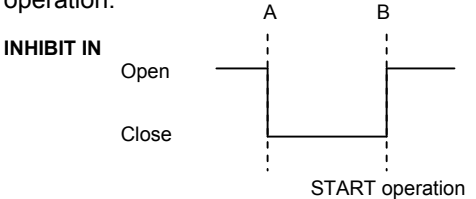
4.6.2 Starting the STP pump after a safety function operates

A safety function operates when an abnormality/error occurs in the STP pump or peripheral equipment. To restart the STP pump, remove the cause of the abnormality/error after the "BRAKE" LED extinguishes and perform the operation shown in Table 14. The "FAILURE" LED extinguishes and the safety function is released (RESET operation). Restart the STP pump. For the safety functions and troubleshooting, refer to Section 6.

Method	Reset Operation
1	Short the circuit between (1)-(22) for 0.3 seconds or more.

Table 14 - Reset operation during remote operation (REMOTE X7)

4.7 Powering OFF

Turn the MAIN POWER "OFF" on the SCU-800 rear panel when all three LEDs "ACCEL.", "NORMAL" and "BRAKE" extinguish. The magnetic bearing stops, the rotor stops, and the "POWER" LED extinguishes. (POWER OFF state)

SCU-800 Control Unit for Turbomolecular Pump

4.8 Operating the TMS unit (for use with the TMS unit)

4.8.1 Before starting

Check the following items before starting:

1. Check that the TMS connection cable is securely connected to the SCU-800.
2. Check that the TMS heater, the TMS valve, the cooling water pipe and the TMS sensor cable are securely connected.

Note: The TMS sensor cable is not required depend on the type of the STP pump.

4.8.2 Starting/Stopping

Power on the STP pump to automatically start the TMS unit.

Power off the STP pump to automatically stop the TMS unit.

While the TMS unit is in operation, the "TEMP CTRL" LED illuminates on the SCU-800.

When STP pump is in the power ON state, the TMS unit operates regardless of the status of the SCU-800. When the STP pump is the cause of the malfunction, the TMS unit is stopped.

4.8.3 Setting the TMS unit function

When the "TEMP CTRL" LED does not illuminate on the SCU-800, after switching MAIN POWER "ON", the TMS function may be set to "DISABLE". Confirm and reset the TMS function according to Section 3.11.

4.8.4 Temperature control

When the temperature of the STP pump base is lower than the setting value, the TMS heater is turned "ON", and the TMS valve is turned "OFF" to heat the STP pump. When the temperature of the STP pump base is higher than the setting value, the TMS heater is turned "OFF", and the TMS valve is turned "ON" to cool the STP pump. The LCD displays the actual temperature of the STP pump base as "TMS TEMP: ** °C".

This page intentionally blank.

5 SERIAL COMMUNICATION PROTOCOL

5.1 Introduction

The SCU-800 is provided with compliant serial interface. Prepare the user application software according to this instruction manual. Operation instructions and information, such as the running state and setting values of the STP pump (information which appears on the LCD of the SCU-800) can be obtained with the software.

The serial ports located on the SCU-800 rear panel are called Serial Interface Module (SIM). Refer to Figure 31.

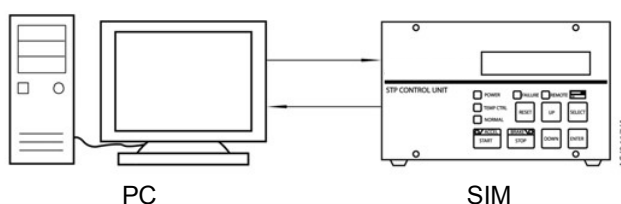

Figure 31 - Serial communication

5.2 Connection and setting up

5.2.1 Signal connection

The STP control unit is equipped with 3 serial ports COM1, COM2 and STP-Link as a standard. Details of the serial ports COM1 and COM2 are as follows:

- Serial Port COM1 (shared use by the RS232/485)

Connect the PC serial port to connectors X3A or X3B (a D-Sub9-pin, socket) on the rear panel. Connect TxD/RxD/GND in the RS232 and D+/D- in the RS485 in accordance with Table 15 (refer to Figure 32). DO NOT connect other pins which are reserved as optional use.

	X3A (D-Sub9 pin, socket)	X3B (D-Sub9 pin, socket)
RS232	2 (TxD)	-
	3 (RxD)	-
	5 (GND)	-
RS485	7 (D-)	7 (D-)
	8 (D+)	8 (D+)
Reserved	1, 4, 6, 9	1, 2, 3, 4, 5, 6, 9

Table 15 - X3A/X3B pin position

SCU-800 Control Unit for Turbomolecular Pump

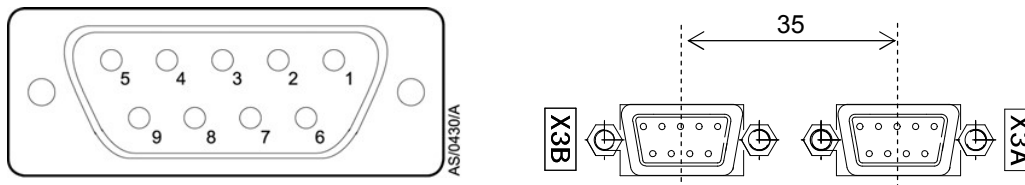

Figure 32 - Connector X3A/X3B (D-sub 9)

Note: The connectors X3A and X3B are fitted using M2.6 screws.

Note: It is recommended to use a communication cable with shield type, and connect both terminals to the ground.

RS232 and RS485 cannot be used at the same time. The factory setting is RS232. When connecting RS485, the change of communication parameter setting is required, refer to Section 3.11.

When connecting RS232, the length of the communication cable should be 15 m or less. When connecting RS485, refer to Section 5.2.2.

- Serial Port COM2 (exclusively used in the RS485)

Connect D+/D- to connector X6 on the rear panel (D-Sub 9 pin, socket) according to Table 16. Other pins are reserved for Input/Output remote function, accordingly, there is no connection to these pins.

Refer to Section 5.2.2.

	X6 (D-Sub 9 pin, socket)
RS485	7 (D+)
	8 (D-)
Unused	1, 2, 3, 4, 5, 6, 9

Table 16 - X6 pin position

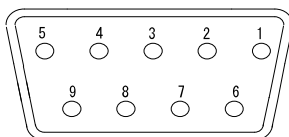

Figure 33 - Connector X6 (D-sub 9)

Note: The connector X6 is fitted using M2.6 screws.

SCU-800 Control Unit for Turbomolecular Pump

- Serial Port STP-Link (exclusively used in the RS232)

Connect signal transmitted from the PC to connector X8 on the front panel. Connect the optional STP-Link communication cable to the PC.

SCU-800 Control Unit for Turbomolecular Pump

5.2.2 Connecting the RS485

Make sure the followings when using the serial port COM1 with RS485 or COM2.

A connection condition is 1 on 1 (single point connection) or 1 on N (multi-point connection).

A maximum number of 32 SIMs are connectable in the multi-point connection.

Use twisted-pair wire in communication cable. The extended communication cables should be 1.2 km or less.

Connect the terminator to the communication devices at both ends of the transmission line. The terminator ($120\ \Omega$, 0.25 W) is required for connection.

(the SCU-800 dose not have terminator setting function)

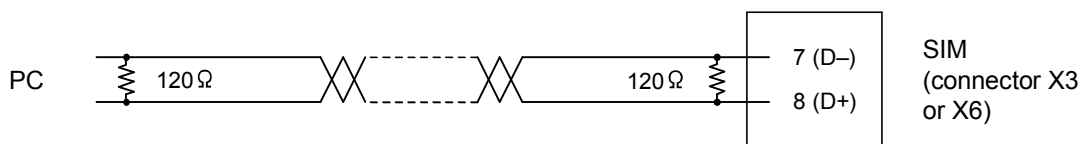

a) RS485 single point connection

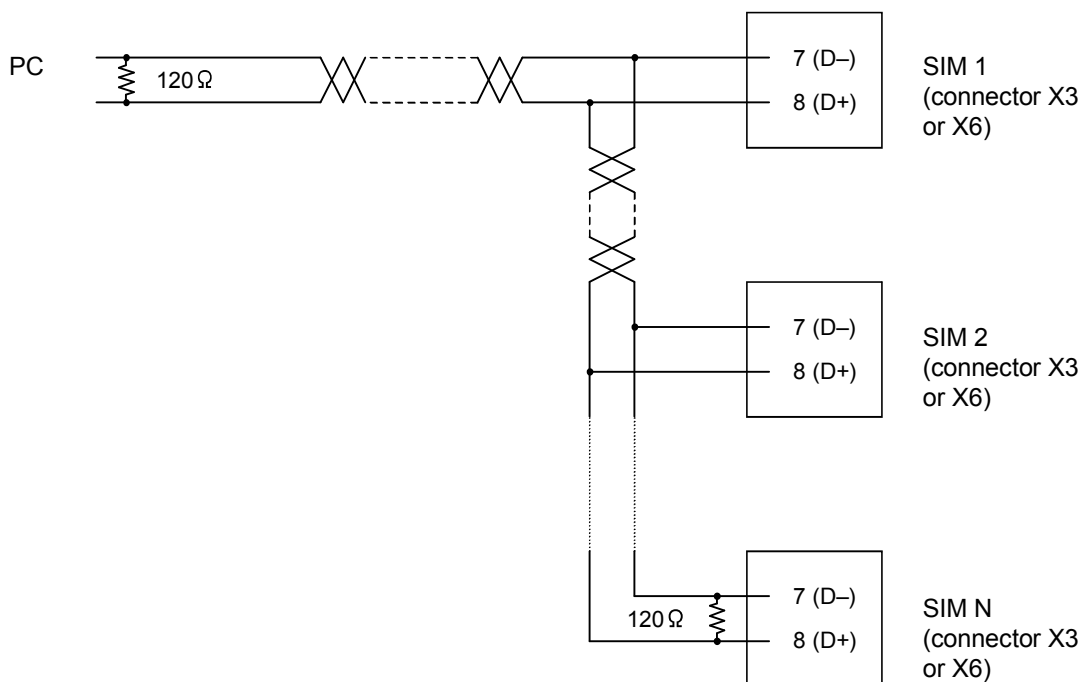

b) RS485 multi-point connection

Figure 34 - RS485 connections

Note: It is recommended to use a communication cable (twisted-pair wire) with shield type, and connect both terminals to the ground.

SCU-800 Control Unit for Turbomolecular Pump

5.2.3 Communication parameter setting

The factory setting of the communication parameter is shown in Table 17. When changing the communication parameter, refer to Section 3.11, "Parameter set mode".

To use the operational commands of the SCU-800 (START, STOP, RESET), set the MANUAL/REMOTE changeover switch on the SCU-800 to "ON", and set a port to use the Remote mode, refer to Figure 9.

When the MANUAL/REMOTE changeover switch is "OFF" or a port which is not set as Remote mode, commands other than the operation commands can be used.

Communication parameter	SCU-800	PC setting example
Remote mode	I/O Remote	I/O Remote, COM1, COM2, STP-Link
Baud rate	9,600 bps	110 to 19,200 bps
Bit length	8 bit	7, 8 bit
Stop bit	1 bit	1, 2 bit
Parity	None	None, Even, Odd
Driver type	RS232	RS232, RS485(Single), RS485(Multi)
RS485ID ^{*1}	1	1 to 127

^{*1} This value is used with "RS485 (Multi)".

Table 17 - Communication parameters

5.3 Protocol specifications

5.3.1 General description

The STP serial communication protocol enables the SIM to receive the communication command (Figure 35, item 1), transmitted from the PC and send a response (Figure 35, item 2), following the communication command. Each communication command from the PC transmits a text message (ASCII text) assigned to each function. Communication commands include control commands (STP pump operation commands, and so forth) and query commands (read-out of STP pump operation mode, and so forth).

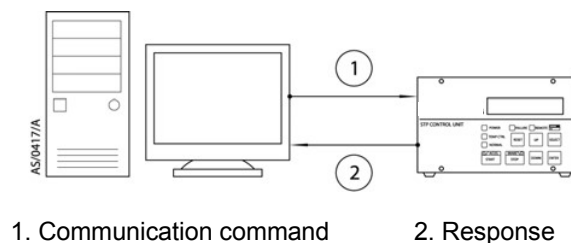

Figure 35 - PC to SIM communication

SCU-800 Control Unit for Turbomolecular Pump

Table 18 shows ASCII characters being used in the transmission control, error control and handshake in the application layer. Note that the transmission frame form differs depending upon the RS232/RS485 single point connection and RS485 multi-point connection. (refer to Section 5.3.8)

	ASCII character	HEX code	Function
Transmission layer	Stx	02	Transmission block start character
	Etx	03	Transmission frame end character
	Etb	17	Transmission block end character
	Ack	06	Acknowledgment response
	Nak	15	Non-acknowledgment response
	@	40	Network frame ID character
Application layer	#	23	Acknowledgment response
	!	21	Non-acknowledgment response

Table 18 - Transmission control characters

5.3.2 Standard transmission frame (in the RS232/RS485 single point connection)

The transmission frame used in the RS232/RS485 single point connection has a single block or multiple transmission blocks. The transmission block consists of a start control character, data block No. (3 digits), a message (up to 255 characters), an end control character and a checksum (Longitudinal Redundancy Check (LRC)). The following table shows the transmission frame where the message transmission character string is C_n .

Transmission frame when a message is below 255 characters ($n \leq 255$):

	1	2	3	4	5		5+n	5+n+1	5+n+2
ASCII	Stx	0	0	1	C_1		C_n	Etx	LRC

"Stx" and "Etx" are used as a start and an end character of the transmission frame, respectively.

SCU-800 Control Unit for Turbomolecular Pump

Transmission frame when a message exceeds 255 characters ($n = 255$, $m \leq 255$, $k =$ the number of transmission blocks):

First		1	2	3	4	5		5+n	5+n+1	5+n+2
Block	ASCII	Stx	0	0	1	C ₁		C _{1n}	Etb	LRC
Second		1	2	3	4	5		5+n	5+n+1	5+n+2
Block	ASCII	Stx	0	0	2	C ₂		C _{2n}	Etb	LRC
Final		1	2	3	4	5		5+m	5+m+1	5+m+2
Block	ASCII	Stx	k			C _k		C _{km}	Et _x	LRC

"Stx" is used as a start character of each transmission block; "Etb" is used as an end character of the transmission block with a message of 255 characters; "Et_x" is used as an end character of the final transmission block (the end character of the transmission frame).

5.3.3 Control command (in the RS232/RS485 single point connection)

A control command is used when transmitting a pump operation command and a setting change command to the SIM. The first character of the control command in the RS232/RS485 single point connection is "Bsp" (a space character, HEX code "20") and succeeding characters are ASCII characters corresponding to the respective function code and parameter.

Bsp	CHR	C ₁	C ₂				C _n
-----	-----	----------------	----------------	--	--	--	----------------

CHR: Function code character, C₁ to C_n: Parameter.

Parameter (from C₁ to C_n) serves as 16 bits signed hexadecimal value coded ASCII text. When a message (a space character, a function code, and parameter) exceeds 255 characters, input "Bsp" and CHR to the top transmission block only (the first transmission block of the transmission frame). It is not necessary to input them to the second and succeeding transmission blocks.

The SIM returns the acknowledgment response character "#" when the control command is processed normally. If not, the SIM returns the non-acknowledgment response character "!" and 3 characters of the non-acknowledgment code are added to "!".

Transmission frame when data is transmitted to one block (a message is less than 256 characters):

Designate the control command on the PC.

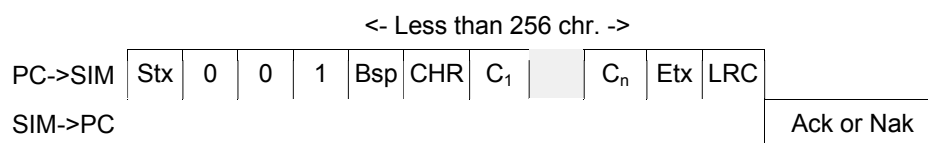

SCU-800 Control Unit for Turbomolecular Pump

Always assign less than 254 characters ($n < 254$) to the parameter so that the message is less than 256 characters.

Then the preceding SIM->PC character is "Ack", the instructed control command is executed and the SIM returns the following response.

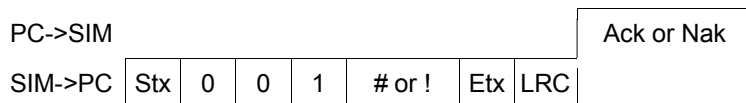

The PC transmits "Ack" or "Nak"; then transmits the next command if necessary.

Transmission frame when data is transmitted to two blocks (message is more than 256 characters and less than 512 characters):

Designate the control command (the 1st block) on the PC

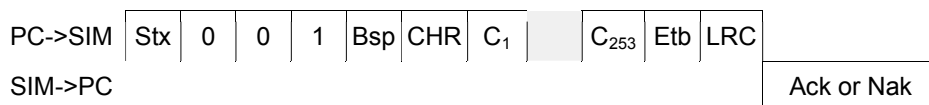

Next, the preceding SIM->PC character is "Ack", the PC continues instructing the control command (the 2nd block).

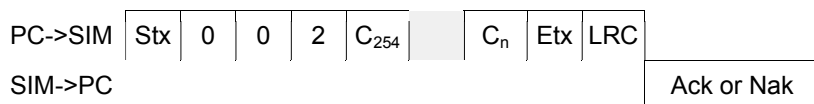

Always assign less than 510 characters ($n < 510$) to the parameter so that the message is less than 512 characters.

Then the preceding SIM->PC character is "Ack", the instructed control command is executed and the SIM returns the following response.

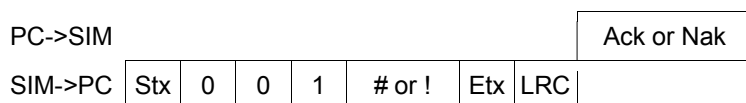

The PC transmits "Ack" or "Nak"; then transmits the next command if necessary.

5.3.4 Query command (in the RS232/RS485 single point connection)

A query command is used to read the pump operation state and setting values. The first character of the query command in the RS232/RS485 single point connection is "?" (HEX code "3F"), and succeeding characters are ASCII characters corresponding to the respective function code and parameter.

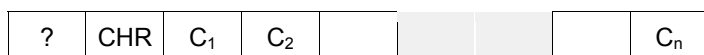

SCU-800 Control Unit for Turbomolecular Pump

CHR: Function code character, C₁ to C_n: Parameter

Parameter (from C₁ to C_n) serves as 16 bits signed hexadecimal value coded ASCII text. When a message (a space character, a function code, and parameter) exceeds 255 characters, input "?" and CHR to the top transmission block only (the first transmission block of the transmission frame). It is not necessary to input them to the 2nd and succeeding transmission blocks.

The SIM returns the acknowledgment response character "#" when the query command is processed normally. If not, the SIM returns the non-acknowledgment response character "!" and 3 characters of the non-acknowledgment code are added to "!".

Transmission frame when data is transmitted at one block and returned at two blocks:

Designate a query command on the PC

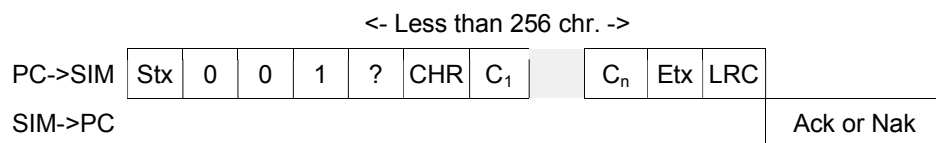

Always assign less than 254 characters (n < 254) to the parameter so that the message is less than 256 characters.

Next, the preceding SIM->PC character is "Ack", the instructed query command is executed and the SIM returns the following response (1st block).

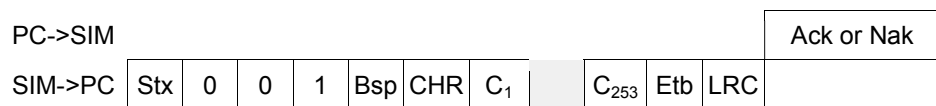

Then "Ack" is sent by the SIM->PC character in reaction to the response (1st block) from the SIM, the SIM returns the following response (2nd block).

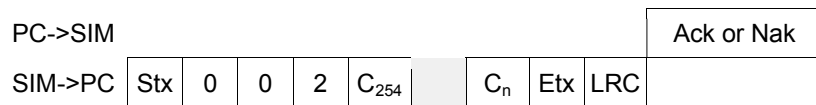

The PC transmits "Ack" or "Nak"; then transmits the next command if necessary.

5.3.5 Transmission data format

Data value is always 16 bits signed hexadecimal value coded ASCII text.

Example: 12090 on a decimal basis equals to 2F3A on a hexadecimal basis.

SCU-800 Control Unit for Turbomolecular Pump

5.3.6 Frame control (checksum)

The transmission frame is controlled by the odd number parity check. First initialize LRC as FF_{hex}. Next calculate LRC by EXCLUSIVE-OR (XOR) of all the frame bytes containing "Stx", "Etb", "Etx" and LRC and transmit the result as LRC.

Examples:

Character string for calculation before calculating LRC.

ASCII	Stx	0	0	1	#	Etx	LRC
HEX	02	30	30	31	23	03	FF

Calculation of LRC:

$$02_{\text{hex}} \text{ XOR } 30_{\text{hex}} \text{ XOR } 30_{\text{hex}} \text{ XOR } 31_{\text{hex}} \text{ XOR } 23_{\text{hex}} \text{ XOR } 03_{\text{hex}} \text{ XOR } FF_{\text{hex}} = EC_{\text{hex}}$$

Character string for transmission after calculating LRC.

ASCII	Stx	0	0	1	#	Etx	LRC
HEX	02	30	30	31	23	03	EC

5.3.7 Error control

- Transmit the transmission frame repeatedly from the PC when the SIM transmits "Nak" (parity check error). When the SIM receives "Nak" from the PC, the transmission frame is transmitted again. This operation is repeated up to 5 times.
- The SIM transmits "Ack" or "Nak" to the PC after the completion of communication command reception. When the PC cannot receive "Ack" or "Nak" after 2 second, retransmit the transmission frame from the PC.

When these communication statuses occur repeatedly, display to an error message or start the error routine on the PC.

5.3.8 Transmission frame in the RS485 multi-point connection

To identify a network frame and ensure the compatibility with a standard transmission frame, add a network frame ID character "@" and a title of 3 characters of network frame number to the transmission frame in the RS485 multi-point connection.

The network frame number is specified by any 16 bits signed hexadecimal value coded ASCII text of 1 to 127, to identify the SIM.

SCU-800 Control Unit for Turbomolecular Pump

Examples: Network frame ID character and number in the multi-point connection

ASCII	@	0	1
HEX	40	30	31

Network frame No "1"

ASCII	@	6	4
HEX	40	36	34

Network frame No "100"

ASCII	@	7	F
HEX	40	37	46

Network frame No "127"

The transmission frame has a single block or multiple transmission blocks. Each transmission block consists of a network frame ID character, a network frame number, a start control character, data block number (3 digits), a message (up to 255 characters), an end control character and a checksum (LRC). The following shows the transmission frame when the message transmission character string is C_n .

Transmission frame when a message is below 255 characters ($n \leq 255$):

	1	2	3	4	5	6	7	8		8+n	8+n+1	8+n+2
ASCII	@	F ₁	F ₂	Stx	0	0	1	C ₁		C _n	Et _x	LRC

"@" is used as a network frame ID character.

"Stx" and "Et_x" are used as a start and an end character of the transmission frame, respectively.

Transmission frame when a message exceeds 255 characters ($n = 255$, $m \leq 255$, k = the number of transmission blocks)

First		1	2	3	4	5	6	7	8		8+n	8+n+1	8+n+2
Block	ASCII	@	F ₁	F ₂	Stx	0	0	1	C ₁		C ₁ _n	Et _b	LRC

Second		1	2	3	4	5	6	7	8		8+n	8+n+1	8+n+2
Block	ASCII	@	F ₁	F ₂	Stx	0	0	2	C ₂		C ₂ _n	Et _b	LRC

Final		1	2	3	4	5	6	7	8		8+m	8+m+1	8+m+2
Block	ASCII	@	F ₁	F ₂	Stx	k			C _k		C _k _m	Et _x	LRC

"@" is used as a network frame ID character.

"Stx" is a start character of each transmission block, and "Et_b" is an end character of the transmission block of a message of 255 characters.

"Et_x" is used as an end character of the final transmission block (end character of the transmission frame).

SCU-800 Control Unit for Turbomolecular Pump

5

5.3.9 Control command in the RS485 multi-point connection

The control command to be used when a pump operation instruction or a setting change instruction is transmitted to the SIM and is arranged in the order specified below. The top is "Bsp" (space character, HEX code "20") and ASCII characters corresponding to the respective function code and parameter follow.

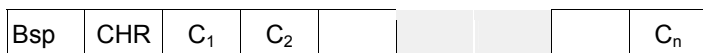

CHR: Function code character, C₁ to C_n: Parameter

Parameter (from C₁ to C_n) serves as 16 bits signed hexadecimal value coded ASCII text. When a message (a space character, a function code, and parameter) exceeds 255 characters, input "Bsp" and CHR to the top transmission block only (the first transmission block of the transmission frame). It is not necessary to input them to the second and succeeding transmission blocks.

The SIM returns the acknowledgment response character "#" when the control command is processed normally. If not, the SIM returns the non-acknowledgment response character "!" and 3 characters of the non-acknowledgment code are added to "!".

Transmission frame when data is transmitted to one block (a message is less than 256 characters):

Designate the control command on the PC.

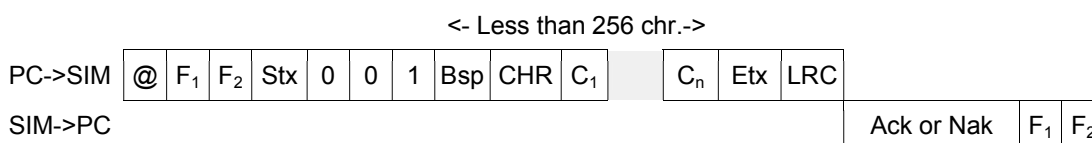

Always assign less than 254 characters (n < 254) to the parameter so that the message is less than 256 characters.

Next, the preceding PC->SIM character is "Ack", the instructed control command is executed and the SIM returns the following response.

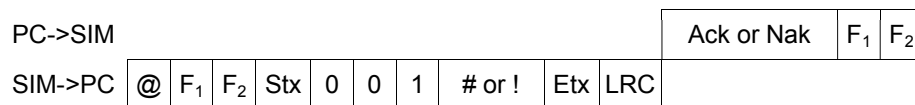

The PC transmits "Ack" or "Nak"; then transmits the next command if necessary.

Transmission frame when data is transmitted to two blocks (message is more than 256 characters and less than 512 characters):

Designate the control command (the 1st block) on the PC.

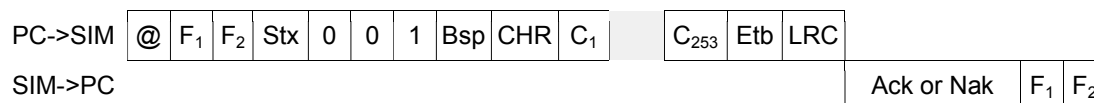

SCU-800 Control Unit for Turbomolecular Pump

Next, the preceding SIM->PC character is "Ack", the PC continues instructing the control command (the 2nd block).

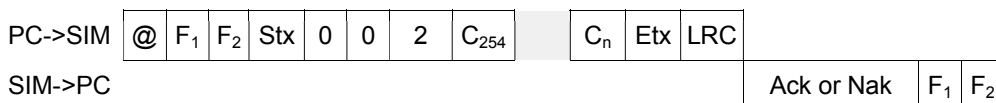

Always assign less than 510 characters (n < 510) to the parameter so that the message is less than 512 characters.

Then the preceding PC->SIM character is "Ack", the instructed control command is executed and the SIM returns the following response.

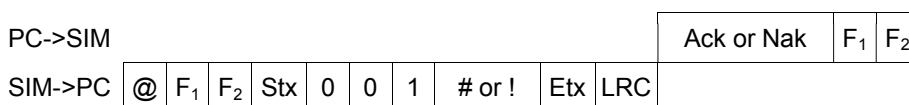

The PC transmits "Ack" or "Nak"; then transmits the next command if necessary.

5.3.10 Query command in the RS485 multi-point connection

The query command to be used when a pump operation instruction or a setting change instruction is transmitted from the SIM and is arranged in the order specified below. The top is "?" (HEX code "3F") and ASCII characters corresponding to the respective function code and parameter follow.

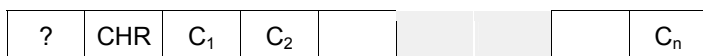

CHR: Function code character, C₁ to C_n: Parameter.

Parameter (from C₁ to C_n) serves as 16 bits signed hexadecimal value coded ASCII text. When a message (a space character, a function code, and parameter) exceeds 255 characters, input "?" and CHR to the top transmission block only (the first transmission block of the transmission frame). It is not necessary to input them to the second and succeeding transmission blocks.

The SIM returns the acknowledgment response character "#" when the query command is processed normally. If not, the SIM returns the non-acknowledgment response character "!" and 3 characters of the non-acknowledgment code are added to "!".

Transmission frame when data is transmitted from one block and returned to two blocks.

Designate a query command on the PC.

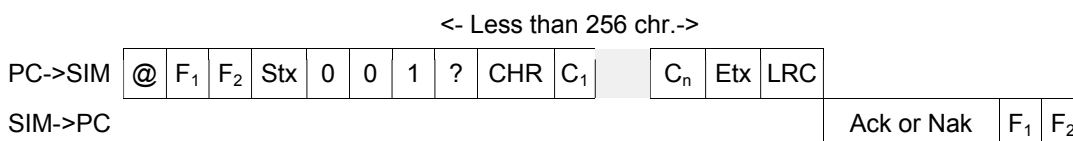

SCU-800 Control Unit for Turbomolecular Pump

Always assign less than 254 characters ($n < 254$) to the parameter so that the message is less than 256 characters.

Next, the preceding SIM->PC character is "Ack", the instructed query command is executed and the SIM returns the following response (1st block).

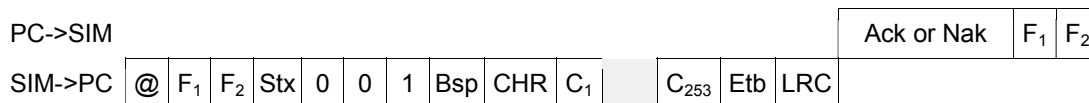

Then "Ack" is sent by the SIM->PC character in reaction to the response (1st block) from the SIM, the SIM returns the following response (2nd block).

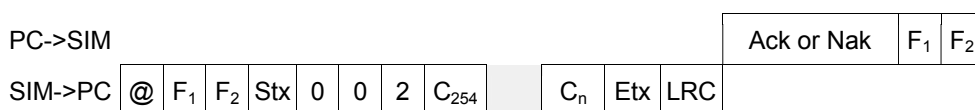

The PC transmits "Ack" or "Nak"; then transmits the next command if necessary.

5.3.11 Broadcasting command in the RS485 multi-point connection

The START or STOP of STP pump operation command can be concurrently instructed to all the multi-connected SIMs. Always assign 0 (HEX code "30", "30") to network frame number. Note that there is no response from the respective SIM.

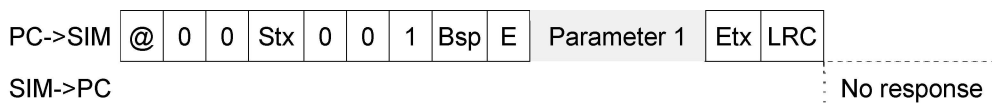

Parameter	Item	Data Format	Remark
1	Pump operation command	8-bits hexadecimal coded ASCII	Refer to Table 19

Pump operation command	Value
START	1
STOP	2

Table 19 - Pump operation commands

SCU-800 Control Unit for Turbomolecular Pump

5.4 Command specifications

5.4.1 Command list

Function code		Command/Query Name	Function
?	D	ReadMeas	Reads the measured rotational speed.
Bsp	E	Command	Sends commands START, STOP, RESET (valid when MANUAL/REMOTE switch is selected ON.)
?	F	ReadFailMess	Reads the errors being detected.
?	M	ReadModFonct	Reads the pump operation mode and the errors being detected.
?	V	ReadVersion	Reads the software version of the SCU-800.
?	c	ReadCounters	Reads serial number, hour counter and start counter.
?	d	ReadSetPoint	Reads the setting values of the speed set point and the TMS temperature.
?	e	ReadMotorTemp	Reads the measured motor temperature.
?	f	ReadStatus	Reads the various settings. (Remote mode, TMS function, INHIBIT and emergency vent valve).
?	g	ReadEvents	Reads the error record.
Bsp	h	SetSpeedSetPoint	Changes the speed set point.
?	h	ReadSpeedSetPoint	Reads the speed set point.
?	m	ReadModFonctWithWarning	Reads the pump operation mode, the errors and the warnings being detected
?	[ReadMeasValue	Reads the TMS temperature, motor temperature and measured rotational speed.

Table 20 - Command list

SCU-800 Control Unit for Turbomolecular Pump

5.4.2 ReadMeas

Function: Reads the measured rotational speed.

Transmission frame:

PC->SIM

Stx	0	0	1	?	D	EtX	LRC
-----	---	---	---	---	---	-----	-----

SIM->PC

Ack

PC->SIM

Ack

SIM->PC

Stx	0	0	1	Bsp	D	Parameter 1 to 2	EtX	LRC
-----	---	---	---	-----	---	------------------	-----	-----

Parameter	Item	Data format	Remarks
1	[System reservation]	56-bits hexadecimal coded ASCII	
2	Measured rotational speed (Unit: Hz)	16-bits hexadecimal coded ASCII	

Example:

Measured rotational speed: 02DC_{hex} = 732 Hz = 43,920 rpm

Parameter	1												2				
ASCII	*1	*1	*1	*1	*1	*1	*1	*1	*1	*1	*1	*1	*1	0	2	D	C
HEX														30	32	44	43

*1 System reservation

5.4.3 Command

Function: Sends the pump operation commands START, STOP and RESET. These commands function in the same way as when each switch of the SCU-800 is pressed. They are valid when MANUAL/REMOTE changeover switch on the SCU-800 is "ON". Refer to Section 3.11, "Parameter set mode".

Transmission frame:

PC->SIM

Stx	0	0	1	Bsp	E	Parameter 1	EtX	LRC
-----	---	---	---	-----	---	-------------	-----	-----

SIM->PC

Ack

PC->SIM

Ack

SIM->PC

Stx	0	0	1	#	EtX	LRC
-----	---	---	---	---	-----	-----

SCU-800 Control Unit for Turbomolecular Pump

Parameter	Item	Data format	Remark
1	Pump operation command	8-bits hexadecimal coded ASCII	Refer to Table 21

Pump operation command	Value
START	1
STOP	2
RESET	4

Table 21 - Pump operation commands

Example:

Pump operation command : RESET operation = 4 = 04_{hex}

Parameter	1	
ASCII	0	4
HEX	30	34

5.4.4 ReadFailMess

Function: Reads the errors being detected. This data is the same data as that of "ReadModFonct" parameter 2 to 79 or "ReadModFonctWithWarning" parameter 3 to 80.

Transmission frame:

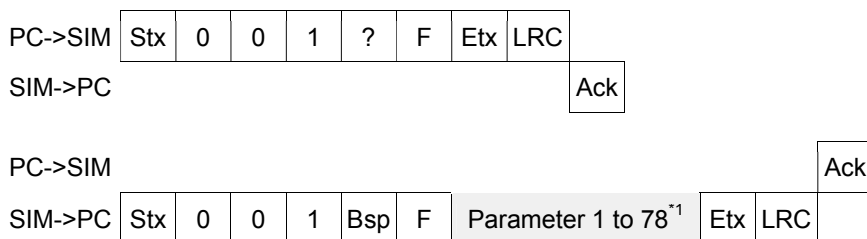

SCU-800 Control Unit for Turbomolecular Pump

Parameter	Item	Data format	Remarks
1	The number of error	8-bits hexadecimal coded ASCII	Up to 77 errors ^{*1}
2 to 78 ^{*1}	Error 1	8-bits hexadecimal coded ASCII	^{*2}
	
	Error 77 ^{*1}	8-bits hexadecimal coded ASCII	

^{*1} The maximum number of errors may differ depending upon the software version of SCU-800. It is recommended that an application be designed as variable-length data.

^{*2} Value corresponding to the error message is transmitted, (refer to Table 22 and Table 23). The most recent error has the largest parameter number. When the number of errors being detected is under the maximum number, the value of parameter that is larger than the number of errors being detected is set to 0.

Example:

The number of error : 02_{hex} = 2 errors
 Error 1 : 0D_{hex} = 13 = Disturbance Xh
 Error 2 : 0F_{hex} = 15 = Disturbance Xb
 Error 3 to 77 : 00_{hex} = No error detected

Parameter	1	2	3	4	5	6	7	8	9	10
ASCII	0 2	0 D	0 F	0 0	0 0	0 0	0 0	0 0	0 0	0 0
HEX	30 32	30 44	30 46	30 30	30 30	30 30	30 30	30 30	30 30	30 30

Parameter	11	12	13	[Omitted]	68	69	70	71	72	73	
ASCII	0 0	0 0	0 0		0 0	0 0	0 0	0 0	0 0	0 0	0 0
HEX	30 30	30 30	30 30		30 30	30 30	30 30	30 30	30 30	30 30	30 30

Parameter	74	75	76	77	78
ASCII	0 0	0 0	0 0	0 0	0 0
HEX	30 30	30 30	30 30	30 30	30 30

SCU-800 Control Unit for Turbomolecular Pump

Error message	Value	Error message	Value
Ram error	0	DSP->PCB Com Fail	33
Eeprom Error	1	PCB->DSP Com Fail	34
TMS Higher Temp	2	TMS Sensor Lost	35
TMS Breaker Trip	3	Tuning Error 1	36
TMS Overheat	4	Tuning Error 2	37
Mains Failure	5	Tuning Error 3	38
Power Supply Failure	6	Tuning Error 4	39
Overspeed 1	7	Tuning Error 5	40
Driver Overvoltage	8	ATMP Failure	41
CAUTION: CNT heat 1	9 ^{*1}	RTMP Failure	42
CNT Overheat 1	10	Imbalance X_H	43 ^{*1}
Driver Overcurrent	11	Imbalance X_B	44 ^{*1}
Driver Overload	12	Imbalance Z	45 ^{*1}
Disturbance X_H	13	Tuning Error 6	46
Disturbance Y_H	14	Tuning Error 7	47
Disturbance X_B	15	Tuning Error 8	48
Disturbance Y_B	16	Tuning Error 9	49
Disturbance Z	17	Driver Failure	50
Motor Overheat	18	R-Unit Failure	51
CAUTION: CNT Heat 2	19 ^{*1}	Motor Resistor Lost	52
CNT Overheat 2	20	Driver PWM Trouble	53
T.Cable Disconnected	21	Driver FAN Failure	54
P.Cable Disconnected	22	Driver CPU Error	55
E.Valve Disconnect	23	R-Unit Com. Failure	56
Driver Com. Failure	24	Amp Overcurrent	57
First Damage Limit	25 ^{*1}	DSP Initialize Fail	58
Second Damage Limit	26	Accel Malfunction	59
START NOT ALLOWED	27	Pump Record Failure	60
Speed Pulse Lost	28	PCB Record Failure	61
Overspeed 2	29	Tuning Error 10	62
Overspeed 3	30	Tuning Error 11	63
M_Temp Sensor Lost	31	Tuning Error 12	64
TMS Lower temp	32	Tuning Error 13	65

Table 22 - Error message values

SCU-800 Control Unit for Turbomolecular Pump

Error message	Value	Error message	Value
Tuning Error 14	66	Aberrant Brake	72
Tuning Error 15	67	Aberrant Accel	73
Tuning Error 16	68	TMS Voltage Mismatch	74
Tuning Error 17	69	Insufficient Supply	75
Tuning Error 18	70	Inordinate Current	76
Tuning Error 19	71		

Table 23 - Error message values (continued)

^{*1} CAUTION or WARNING message. It is not a state of failure. Refer to Section 7 for details. The STP pump will continue to operate after one of these messages is displayed. It is recommended that an application be designed with this in consideration.

5.4.5 ReadModFonct

Function: Reads the pump operation mode and the errors being detected. The data of errors being detected reads the same data as that of "ReadFailMess".

Transmission frame:

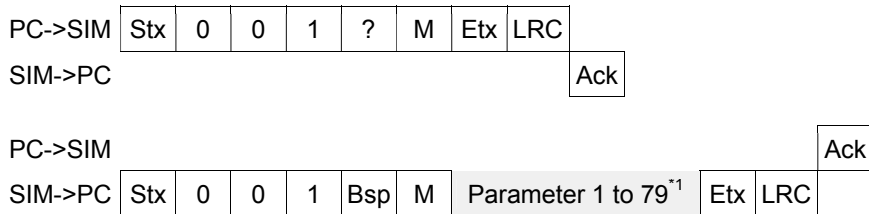

Parameter	Item	Data format	Remarks
1	Pump operation mode	8-bits hexadecimal coded ASCII	Refer to Table 24
2	The number of error	8-bits hexadecimal coded ASCII	Up to 77 errors ^{*1}
3 to 79 ^{*1}	Error 1	8-bits hexadecimal coded ASCII	^{*2}
	
	Error 77 ^{*1}	8-bits hexadecimal coded ASCII	

^{*1} The maximum number of errors may differ depending upon the software version of SCU-800. It is recommended that an application be designed as variable-length data.

^{*2} Value corresponding to the error message is transmitted (refer to Table 22 and Table 23). The most recent error has the largest parameter number. When the number of errors being detected is under the maximum number, the value of parameter that is larger than the number of errors being detected is set to 0.

SCU-800 Control Unit for Turbomolecular Pump

Pump operation mode	Value
Levitation	1
No Levitation	2
Acceleration	3
Normal	4
Deceleration (Brake)	5
Autotest	6
Tuning	7
Tuning Complete	8
(Updating control loop S/W)	9
(Waiting to Update Driver S/W)	10
(Updating Driver S/W)	11

Table 24 - Pump operation mode

Example:

Pump operation mode : 01_{hex} = 1 = Levitation
 The number of error : 02_{hex} = 2 errors
 Error 1 : 0D_{hex} = 13 = Disturbance Xh
 Error 2 : 0F_{hex} = 15 = Disturbance Xb
 Error 3 to 77 : 00_{hex} = No error detected

Parameter	1	2	3	4	5	6	7	8	9	10	11
ASCII	0	1	0	2	0	D	0	F	0	0	0
HEX	30	31	30	32	30	44	30	46	30	30	30

Parameter	12	13	[Omitted]									
ASCII	0	0	0	0	68	69	70	71	72	73	74	75
HEX	30	30	30	30	30	30	30	30	30	30	30	30

Parameter	76	77	78	79
ASCII	0	0	0	0
HEX	30	30	30	30

SCU-800 Control Unit for Turbomolecular Pump

5.4.6 ReadVersion

Function: Read the software version of the SCU-800.

Transmission frame:

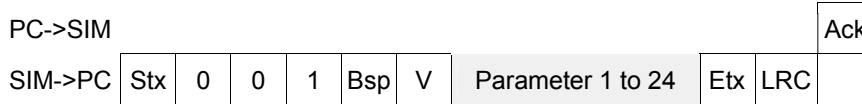
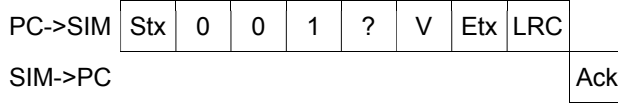

Parameter	Item	Data format	Remarks
1 to 16	Control unit software version	8-bits hexadecimal coded ASCII	
17 to 20	Motor driver software version	4-bits ASCII character	Ver.1.2 = 0120
21 to 24	AMB parameter version (Digital control loop)	4-bits ASCII character	Ver.33.1.0 = 3310 ^{*1}

*1 SCU-800 uses a digital control loop.

Example:

Control unit software version : 34395F4120312E3020202020202020hex = 49_A 1.0

Motor driver software version : 0120_{hex} = 1.2

AMB parameter version : 3310_{hex} = 33.1.0

Parameter	1	2	3	4	5	6	7	8	9	10
	"4"	"9"	"_"	"A"	" "	"1"	."	"0"	" "	" "
ASCII	3 4	3 9	5 F	4 1	2 0	3 1	2 E	3 0	2 0	2 0
HEX	33 34	33 39	35 46	34 31	32 30	33 31	32 45	33 30	32 30	32 30

Parameter	11	12	13	14	15	16	17	18	19	20	21	22	23	24
	" "	" "	" "	" "	" "	" "	/	/	/	/	/	/	/	/
ASCII	2 0	2 0	2 0	2 0	2 0	2 0	0 1	2 0	3 3	1 0				
HEX	32 30	32 30	32 30	32 30	32 30	32 30	30 31	32 30	33 33	31 30				

SCU-800 Control Unit for Turbomolecular Pump

5.4.8 ReadSetPoint

Function: Reads the setting value of the "Speed Set Point" and TMS temperature. The "Speed Set Point" data is the same data as that of "ReadSpeedSetPoint".

Transmission frame:

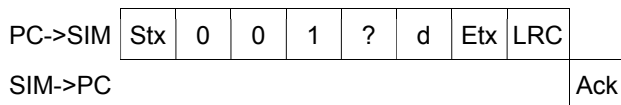

Parameter	Item	Data format	Remarks
1	Speed Set Point (Unit: Hz)	16-bits hexadecimal coded ASCII	
2	TMS temperature setting (Unit: °C)	16-bits hexadecimal coded ASCII	

Example:

Speed Set Point : 01F4_{hex} = 500 Hz = 30,000 rpm

TMS temperature setting : 003C_{hex} = 60 °C (140 °F)

Parameter	1				2			
ASCII	0	1	F	4	0	0	3	C
HEX	30	31	46	34	30	30	33	43

5.4.9 ReadMotorTemp

Function: Reads the measured motor temperature.

Transmission frame:

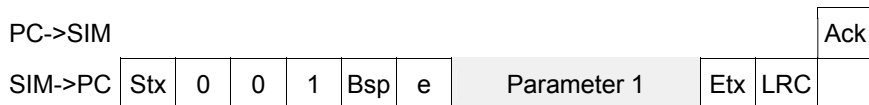
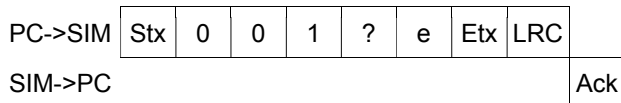

SCU-800 Control Unit for Turbomolecular Pump

Remote mode	Value
I/O Remote	1
COM1	2
COM2	5
STP-Link	6
[System reservation]	3, 4, 7

Table 25 - Remote mode

Example:

Remote mode setting : 01_{hex} = I/O Remote
 TMS function setting : 00_{hex} = ENABLE
 INHIBIT setting : FF_{hex} = DISABLE
 Emergency vent valve setting : FF_{hex} = DISABLE

Parameter	1		2		3		4	
ASCII	0	1	0	0	F	F	F	F
HEX	30	31	30	30	46	46	46	46

5.4.11 ReadEvents

Function: Reads the "Error Record". It has the most recent 10 errors that have been detected.

Transmission frame:

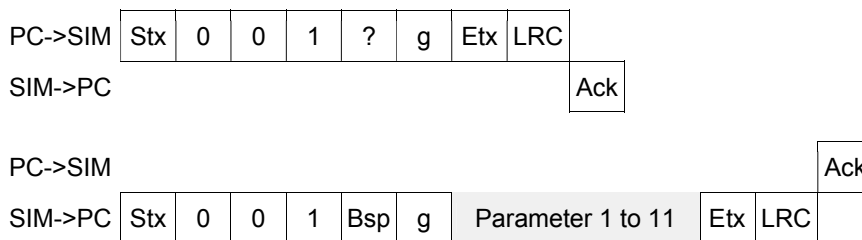

SCU-800 Control Unit for Turbomolecular Pump

Parameter	Item	Data format	Remarks
1	The number of "Error Record"	8-bits hexadecimal coded ASCII	Up to 10 errors
2 to 11	Error Record 1 to Error Record 10	8-bits hexadecimal coded ASCII	*1

*1 Value corresponding to the error message is transmitted (refer to Table 22 and Table 23). The most recent error has the smallest parameter number. When the number of errors being detected is under the maximum number, the value of parameter that is larger than the number of errors has been detected is set to 0.

Example:

When 3 errors have been detected in the past;

- The number of "Error Record" : 03_{hex} = 3 errors
- Error Record 1 : 0F_{hex} = 15 = Disturbance Xb
- Error Record 2 : 0D_{hex} = 13 = Disturbance Xh
- Error Record 3 : 15_{hex} = 21 = T.Cable Disconnected
- Error Record 4 to 10 : 00_{hex} = No error recorded

Parameter	1	2	3	4	5	6	7	8	9	10	11
ASCII	0 3	0 F	0 D	1 5	0 0	0 0	0 0	0 0	0 0	0 0	0 0
HEX	30 33	30 46	30 44	31 35	30 30	30 30	30 30	30 30	30 30	30 30	30 30

5.4.12 SetSpeedSetPoint

Function: Changes the "Speed Set Point" value. This value can be changed in the range from half of the rated rotational speed to the rated rotational speed.

Transmission frame:

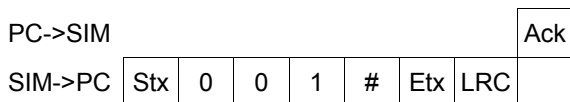
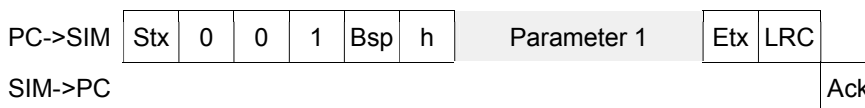

SCU-800 Control Unit for Turbomolecular Pump

Parameter	Items	Data format	Remark
1	Speed Set Point (Unit: Hz)	16-bits hexadecimal coded ASCII	*1

*1 When the parameter value is larger than the rated rotational speed, it is automatically set to the rated rotational speed. When the parameter value is smaller than half of rated rotational speed, it is automatically set to half of rated rotational speed. The value of "Speed Set Point" displayed in LCD of SCU-800 is in increments of 500 rpm.

Example:

Speed Set Point : 01F4_{hex} = 500 Hz = 30,000 rpm

Parameter	1			
ASCII	0	1	F	4
HEX	30	31	46	34

5.4.13 ReadSpeedSetPoint

Function: Reads the "Speed Set Point" value. This value is the same as "ReadSetPoint" parameter 1 (Speed Set Point).

Transmission frame:

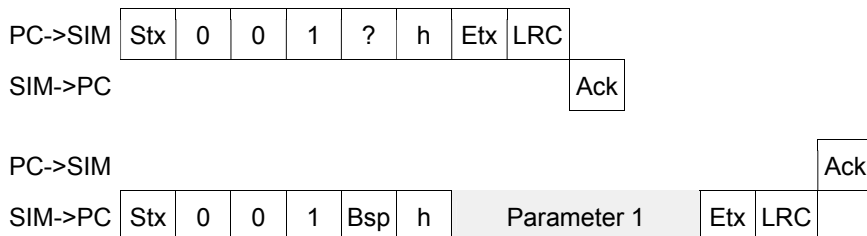

Parameter	Item	Data format	Remark
1	Speed Set Point (Unit: Hz)	16-bits hexadecimal coded ASCII	

Example:

Speed Set Point : 0320_{hex} = 800 Hz = 48,000 rpm

Parameter	1			
ASCII	0	3	2	0
HEX	30	33	32	30

SCU-800 Control Unit for Turbomolecular Pump

5.4.14 ReadModFonctWithWarning

Function: Reads the pump operation mode, errors and warnings being detected. The data of errors being detected data is the same data as that of "ReadFailMess".

Transmission Frame:

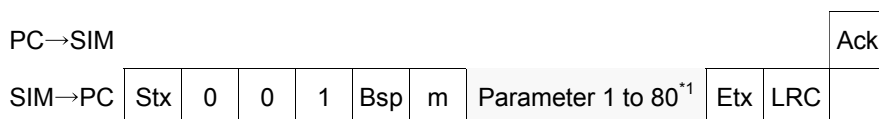
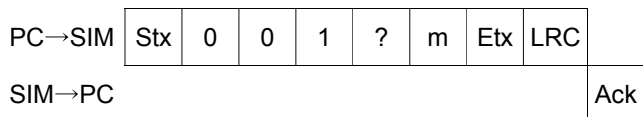

Parameter	Item	Data format	Remark
1	Pump operation mode	8-bits hexadecimal coded ASCII	See Table 23
2	WARNING being detected	16-bits hexadecimal coded ASCII	See Table 26
3	The number of errors detected	8-bits hexadecimal coded ASCII	Up to 77 errors ^{*1}
4 to 80 ^{*1}	Error 1	8-bits hexadecimal coded ASCII	^{*2}
	...		
	Error 77 ^{*1}	8-bits hexadecimal coded ASCII	

^{*1} The maximum number of errors may differ depending upon the software version of the SCU-800. It is recommended that an application be designed as variable-length data.

^{*2} Value corresponding to the error message is transmitted. (see Table 22 and Table 23)

The recent error has the largest parameter number. When the number of errors being detected is under the maximum number, the value of parameter that is larger than the number of errors being detected is set to 0.

SCU-800 Control Unit for Turbomolecular Pump

Bit	Warning message	16-bits hex value
0	WARNING: Bad Pump Transmit	0001
1	WARNING: Second Damage Limit	0002
2	WARNING: First Damage Limit	0004
3	WARNING: Imbalance X_H	0008
4	WARNING: Imbalance X_B	0010
5	WARNING: Imbalance Z	0020
6	WARNING: Pump Run Time Over	0040
7	WARNING: Pump Overload	0080
8	WARNING: Pump record bungle	0100
9	WARNING: PCB record bungle	0200
10	WARNING: Low RTC Battery	0400
11	WARNING: Clock Data is Lost	0800
12	WARNING: Recover by AUX Data	1000
13	[System reservation]	2000
14	[System reservation]	4000
15	[System reservation]	8000

Table 26 - Warning value bit assign

SCU-800 Control Unit for Turbomolecular Pump

Example:

Pump operation mode : 01_{hex} = 1 = Levitation
 WARNING being detected : 0098_{hex} = 0008_{hex} OR 0010_{hex} OR 0080_{hex} =
 3 warnings of "WARNING: Imbalance X_H", "WARNING:
 Imbalance X_B" and "WARNING: Pump Overload"
 The number of error : 02_{hex} = 2 errors
 Error 1 : 0D_{hex} = 13 = Disturbance Xh
 Error 2 : 0F_{hex} = 15 = Disturbance Xb
 Error 3 to 77 : 00_{hex} = No error detected

Parameter	1		2				3		4		5		6		7		8		9		10	
ASCII	0	1	0	0	9	8	0	2	0	D	0	F	0	0	0	0	0	0	0	0	0	0
HEX	30	31	30	30	39	38	30	32	30	44	30	46	30	30	30	30	30	30	30	30	30	30

Parameter	11		12				13		[Omitted]	68		69		70		71		72		73		74	
ASCII	0	0	0	0	0	0	0	0		0	0	0	0	0	1	0	2	0	D	0	F	0	F
HEX	30	30	30	30	30	30	30	30		30	30	30	30	30	30	30	30	30	30	30	30	30	30

Parameter	75		76				77		78		79		80	
ASCII	0	0	0	0	0	0	0	0	0	0	0	0	0	0
HEX	30	30	30	30	30	30	30	30	30	30	30	30	30	30

SCU-800 Control Unit for Turbomolecular Pump

5.4.15 ReadMeasValue

Function: Reads the TMS temperature, motor temperature and measured rotational speed. The motor temperature value is the same temperature as "ReadMotorTemp". The measured rotational speed value is the same as "ReadMeas" parameter 2 (Measured rotational speed).

Transmission frame:

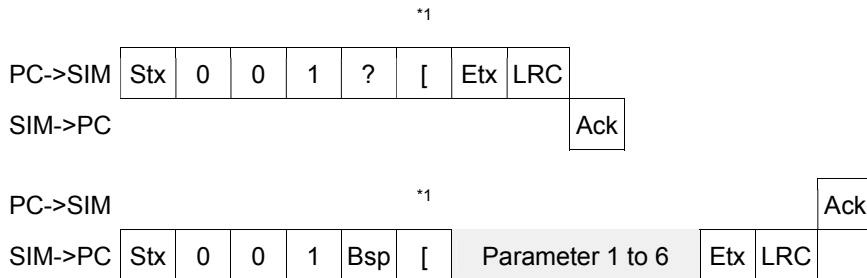

*1 The HEX code of ASCII character '[' is "5B".

Parameter	Item	Data format	Remark
1	[System reservation]	120-bits hexadecimal coded ASCII	
2	TMS temperature (Unit °C)	16-bits hexadecimal coded ASCII	
3	Motor temperature (Unit °C)	16-bits hexadecimal coded ASCII	
4	[System reservation]	40-bits hexadecimal coded ASCII	
5	Measured rotational speed (Unit: Hz)	16-bits hexadecimal coded ASCII	
6	[System reservation]	64-bits hexadecimal coded ASCII	

SCU-800 Control Unit for Turbomolecular Pump

Example:

TMS temperature: 003C_{hex} = 60 °C (140°F)
 Motor temperature: 0014_{hex} = 20 °C (68°F)
 Measured rotational speed: 02DC_{hex} = 732 Hz = 43,920 rpm

Parameter	1															
ASCII	*1	*1	*1	*1	*1	*1	*1	*1	*1	*1	*1	*1	*1	*1	*1	*1
HEX																

Parameter	1											2			
ASCII	*1	*1	*1	*1	*1	*1	*1	*1	*1	*1	*1	0	0	3	C
HEX												30	30	33	43

Parameter	3				4								5				
ASCII	0	0	1	4	*1	*1	*1	*1	*1	*1	*1	*1	*1	0	2	D	C
HEX	30	30	31	34										30	32	44	43

Parameter	6														
ASCII	*1	*1	*1	*1	*1	*1	*1	*1	*1	*1	*1	*1	*1	*1	*1
HEX															

*1 System reservation



SCU-800 Control Unit for Turbomolecular Pump

5

SERIAL COMMUNICATION PROTOCOL

This page intentionally blank.

6 STP-Link

The "STP-Link" is a Windows application for operating the STP pump, confirming the pump status or setting various settings. Table 27 shows the principal functions.

See the Instruction Manual of the "STP-Link" for the detailed specification and operating method.

Item	Functions
Confirmation function	Software version
	Pump serial No.
	Control unit serial No.
	STP pump model
Communication specification setting function	Remote operation mode setting
	Each serial port setting
Option setting function	Rotational speed setting
	TMS setting
	Rotation inhibit signal setting
	Emergency vent valve setting
	Pump air-cooling fan setting
	Warning function setting
History confirmation function	Confirmation of pump operation hours
	Confirmation of control unit operation hours
	Confirmation of damage integrated value
	Confirmation of error history
Record function	Record of setting

Table 27 - Functions of STP-Link



SCU-800 Control Unit for Turbomolecular Pump

6

STP-LINK

This page intentionally blank.

7 MAINTENANCE

The SCU-800 is provided with safety functions for various abnormalities/errors. If an abnormality/error is found when using the STP pump, check it and take measures in accordance with the following procedures. If you cannot trace it or if the STP pump does not function normally after the troubleshooting, fill in the necessary information in the "Return Declaration" and fax it to Service office.

7.1 Safety functions

7.1.1 Power failure

When the power voltage drops below 80 V due to a power failure or another fault, the normal operation of the magnetic bearing is maintained at the high rotational speed using the regenerative energy of the rotating rotor (backup operation during a power failure).

The lowest rotational speed to which the magnetic bearing can operate at a power failure is called a backup rotational speed. The lowest backup rotational speeds vary according to the model of STP pump used, refer to Table 28.

- When the rotational speed is at backup rotational speed or more at a power failure:
The SCU-800 detects any power failure of 2 seconds or more and the STP pump decelerates. At this time, the "POWER" LED extinguishes and the "FAILURE" LED illuminates. The LCD displays "Mains Failure". An alarm signal is output from REMOTE X7 pins (14)-(33) and (15)-(33). When the rotational speed reaches the backup rotational speed, the rotor lands on the touch down bearing and stops. The "FAILURE" LED extinguishes and the LCD is turned off. The alarm signal output is reset.
The SCU-800 does not detect a power failure of less than 2 seconds and the STP pump will continue to rotate.
- When the rotational speed is less than backup rotational speed at a power failure:
The SCU-800 does not detect the power failure. The rotor lands on the touch down bearing and stops.

Connected pump	Backup rotational speed
STP-603/1003 series	Approximately 8,000 rpm
STP-H301/H451 series	Approximately 15,000 rpm
STP-H803/H1303 series	Approximately 8,000 rpm
STP-A803/A1303 series	Approximately 8,000 rpm
STP-A1603 series	Approximately 8,500 rpm

Table 28 - Backup rotational speed

SCU-800 Control Unit for Turbomolecular Pump

Table 29 shows the status of LCD, LEDs, and REMOTE output signals at a power failure.

Rotational speed	Duration of power failure	LCD	LEDs		REMOTE output signal (REMOTE X7)		
		Error messages	POWER LED	FAILURE LED	POWER	ALARM	
						N.O.	N.C.
Backup rotational speed or more	Approx. 2 sec. or more	Mains Failure	Extinguish	Illuminate	Open	Close	Open
	Less than approx. 2 sec.	Continues as before					
Less than Backup rotational speed	X	OFF	Extinguish	Extinguish	Open	Open	Close

Table 29 - States of LCD, LEDs and REMOTE output signals at a power failure

7.1.2 Operation after a power recovery

1. The STP pump continues decelerating, and power failure detection is reset automatically.

At this time, the "POWER" LED illuminates and the "FAILURE" LED extinguishes. Also, POWER OUT pins (4)–(16) is closed, and a failure signal is reset between FAILURE OUT pins (8)–(21) and (9)–(21) of the "X2 REMOTE" connector.

2. When the START operation is performed after a power recovery, the STP pump reaccelerates even while it is in BRAKE state.

However, the SCU-800 may detect excessive vibration when power is recovered after the rotor lands on the touch down bearing (see Section 7.1.4). In this case, the STP pump once stops and cannot reaccelerate until the RESET operation completed (see Section 4.5.7).

Note: It is recommended to establish a procedure so that the power can be supplied to the SCU-800 immediately after a power recovery.

7.1.3 Abnormal state of magnetic bearing

CAUTION

When an abnormality/error occurs in the magnetic bearing, check the STP pump as well as the SCU-800. If "FAILURE" cannot be released after reset operation, contact Service office.

When the magnetic bearing does not function normally due to a breakage of the STP connection cable, disconnection of connectors or any abnormality/error of the STP control circuit, the rotor lands on the touch down bearing and stops. The "FAILURE" LED illuminates and the LCD displays error message "Disturbance *".

SCU-800 Control Unit for Turbomolecular Pump

7.1.4 Excessive vibration

When serious vibration or mechanical shock causes the rotor to come in contact with the touch down bearing (due to external vibration/impact, intrusion of atmosphere or foreign matter into the STP pump or rotor imbalance), the STP pump decelerates and stops.

The "FAILURE" LED illuminates and the LCD displays error message "Disturbance **".

7.1.5 Motor driver overload

When the STP pump does not attain the rated speed within approximately 30 minutes after starting or when the ACCELERATION state remains unchanged during operation for approximately 30 minutes, the STP pump decelerates and stops.

The "FAILURE" LED illuminates and the LCD displays error message "Driver Overload".

7.1.6 Overheating inside the STP pump

When the motor inside the STP pump overheats due to an abnormal high temperature or overload operation, the STP pump decelerates and stops.

The "FAILURE" LED illuminates and the LCD displays error message "Motor Overheat".

7.1.7 Overheating inside the SCU-800

The temperature in the SCU-800 increases when the ventilating duct is blocked or the ambient temperature is high. The LCD displays error message "CAUTION : CNT heat**" when the inside of the SCU-800 overheats. In this case, the pump does not stop.

When the SCU-800 overheats continuously, the STP pump decelerates and stops.

The "FAILURE" LED illuminates and the LCD displays error message "CNT Overheat **".

7.1.8 Overspeed

When the rotational speed of the STP pump exceeds the specified rotational value due to a failure in the motor driver, the MAIN POWER on the SCU-800 switches "OFF". The STP pump has no power supplied, decelerates and stops.

The "FAILURE" LED illuminates and the LCD displays error message "Overspeed **".

SCU-800 Control Unit for Turbomolecular Pump

7

MAINTENANCE

7.1.9 Abnormality/Error in the TMS unit (for use with the TMS unit)

If the temperature of the STP pump base unit is higher than the setting value by 10 °C (18 °F) or more due to the occurrence of an abnormality/error in the TMS heater or other fault, the "FAILURE" LED illuminates and the LCD displays error message "TMS Higher Temp". The heater is switched OFF and the cooling water unit is operated. The STP pump decelerates and stops. Continue to operate the cooling water unit while "TMS Higher Temp" is displayed after the pump stops.

If the temperature of the STP pump base unit is lower than the setting value by 10 °C (18 °F) or more due to the occurrence of an abnormality/error in the TMS heater or other fault, the "FAILURE" LED illuminates and the LCD displays the error message "TMS Lower Temp". The heater and the cooling water valve are switched OFF and the STP pump decelerates and stops.

Note: "TMS Lower Temp" is not detected for a certain time when the STP pump starts.

When an abnormality/error occurs in the TMS connection cable, the STP pump decelerates and stops. The heater and the cooling water unit are switched OFF. The "FAILURE" LED illuminates and the LCD displays the error message "T.Cable Disconnect".

7.1.10 Failure of the air-cooling fan

When the air-cooling fan in the SCU-800 locks and stops, the "FAILURE" LED illuminates and the LCD displays error message "Driver Failure" and "Driver Fan Failure". The STP pump decelerates and stops.

SCU-800 Control Unit for Turbomolecular Pump

7.2 "WARNING" message function

7.2.1 "WARNING" message display function

The SCU-800 is provided with a "WARNING" message to display when an overhaul is needed following a self test. When a "WARNING" appears in the upper left hand corner of the LCD, press the "ENTER" switch to display the warning message for seconds (The "ENTER" switch can also be used in REMOTE mode).

The warning signal is output from the remote output terminal of the remote connector X7 while the alert message is displayed (see Table 10). Overhaul the STP pump when "WARNING" message is displayed

Example:

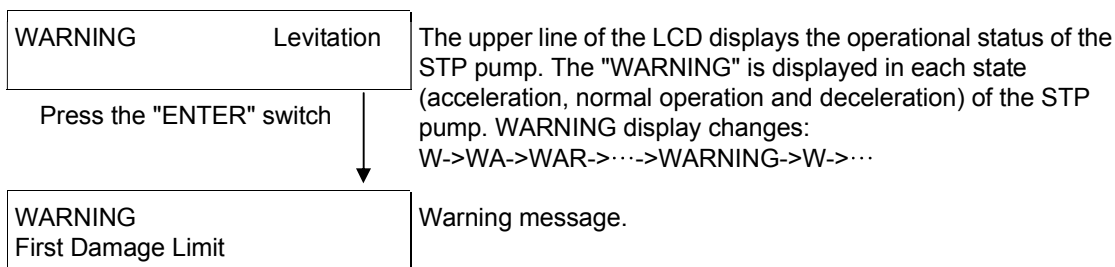

Note: The "WARNING" message cannot be reset by the "RESET" switch. See Section 7.3, "WARNING" message description" for the resetting the "WARNING" message. The STP pump can operate even when the "WARNING" message is displayed except when the "Second Damage Limit" is displayed.

SCU-800 Control Unit for Turbomolecular Pump

7.3 "WARNING" message description

7.3.1 Damage point function

Impact of the STP pump rotor onto the touch-down bearing, such as by an unexpected in-rush of air from outside or in the event of power failure, can damage the touch-down bearings. The SCU-800 monitors these impacts and assigns damage points to the event of "Disturbance" or "Mains Failure". The damage point increases with the rotational speed up to 15 point for each "Disturbance", and 1 point for each touch-down at "Mains Failure".

Refer to Section 3.10, "Confirmation Mode" about confirmation method of damage point.

STP pump	Warning message	
	First Damage Limit	Second Damage Limit
STP-603/1003 series STP-H301/H451 series STP-H803/H1303 series STP-A803/A1303 series STP-A1603 series	120 or more	150 or more

Table 30 - Accumulated damage point and warning message

7.3.2 First damage limit

"First Damage Limit" is displayed when the accumulation point attains the setting value shown in Table 30. The rotating operation can be performed though "WARNING" message is displayed. It is recommended to have the STP pump overhauled as soon as possible.

7.3.3 Second damage limit

"Second Damage Limit" is displayed when continuing to operate the STP pump after "First Damage Limit" is displayed and the accumulation of the damage point attains the setting value by further "Disturbance" and "Mains Failure".

Overhaul the STP pump because the STP pump cannot perform the rotational operation when "Second Damage Limit" is displayed.

When operating the STP pump is needed after "Second Damage Limit" is displayed, disable the "Second Damage Limit". The rotating operation can be performed even though the "WARNING" message is displayed. Refer to Section 3.11 for the setting method.

SCU-800 Control Unit for Turbomolecular Pump

7.3.4 Imbalance X_H, X_B, Z

Imbalance of the rotor of the STP pump is always monitored. Either "Imbalance X_H", "Imbalance X_B" or "Imbalance Z" is displayed when imbalance of the synchronized rotor with the rotational speed exceeds the setting value.

When the deposit accumulates in the STP pump, with the increase of the STP pump operation hours, the rotor balance is lost and the imbalance increases gradually. An increase in the amount of deposit may lead to a malfunction of the STP pump. Perform the overhaul ahead usual case.

The setting value of the imbalance is fixed, and the user cannot set it.

Set the "WARNING" function of the Enable/Disable to Disable to release the "Imbalance X_H", "Imbalance X_B" or "Imbalance Z". (see Section 3.11, "Parameter Set Mode")

7.3.5 Pump run time over

The totalising counter adding up the rotation hours is installed in the SCU-800.

The counter value can be confirmed on the LCD. (see Section 3.10, "Confirmation Mode")

"Pump Run Time Over" is displayed when the counter value attains the setting value. When deposit accumulates inside the STP pump, this function can be used to consider the time of the overhaul. The setting value is user-definable. Refer to "3.11 Parameter Set Mode" for the setting method. "Pump Run Time Over" warning can be reset by setting the warning function to disable after it is occurred. (see Section 3.11, "Parameter Set Mode")

7.3.6 Pump overload

"Pump Overload" is displayed when the state that the motor current exceeding the setting value continues during the fixed time. The state that the STP pump rotational speed drops below the setting value continues during the fixed time. However, the motor current and the rotational speed are monitored only in the NORMAL state.

When the deposit accumulates in the STP pump, the load in NORMAL state may gradually grow with the operating time. Considering the time of the overhaul, this "WARNING" function can be used.

The current setting value and rotational speed setting value are user-definable. "Pump Overload" warning can be released by setting the warning function to disable after it is occurred. (see Section 3.11, "Parameter Set Mode")

7.3.7 Low RTC battery

The lithium battery for the display function of the date/time is installed in the SCU-800. "Low RTC Battery" is displayed when the decrease in the voltage of the battery is detected.

The STP pump can operate though some failure occurs such as the time of the error history is not correct when the voltage of the battery is low.

"Low RTC Battery" message cannot be released without exchanging the battery.

Contact us when exchanging the battery. The decomposition of the SCU-800 is necessary.

SCU-800 Control Unit for Turbomolecular Pump

7.4 "WARNING" function setting

The following "WARNING" functions can be set to Enable or Disable. Refer to Section 3.11, "Parameter Set Mode" for the setting method. See Table 31 and Table 32 for the default setting.

7

MAINTENANCE

Message	Default setting	User setting	User setting change (threshold)
WARNING First Damage Limit	Enable	Enable	Disable
WARNING Second Damage Limit	Enable	Enable	Disable
WARNING Imbalance X_H, Imbalance X_B, Imbalance Z	Enable	Enable	Disable
WARNING Pump Run Time Over	Disable	Enable	Enable
WARNING Pump Overload	Disable	Enable	Enable
WARNING Low RTC Battery	Enable	Disable	Disable

Table 31 - Default setting of "WARNING" function

Message	Default setting		User setting	User setting change (threshold)
WARNING Pump Run Time Over	0 hour		0 to 30 million hours	It can be set in units of 100 hours. 0 is not counted.
WARNING Pump Overload	Motor current	100%	0 to 100%	The ratio to the rated current value. Smaller value has high possibility to get "WARNING".
	Rotational speed	0%	0 to 100%	The rate to the rated current value. Larger value has high possibility to get "WARNING".

Table 32 - Factory setting and variable range

SCU-800 Control Unit for Turbomolecular Pump

7.5 Error at self test state

When an abnormality/error occurs during the self test while operating the ON switch, the safety function operates, the "FAILURE" LED illuminates and an alarm signal is output from the REMOTE X7 connector (see Table 10). An error message showing "CAUTION" on the upper line and the contents of the error are displayed on the lower line of the LCD. If an abnormality/error is found, take measures in accordance with Table 33.

LCD Messages	Probable causes	Countermeasures	Referred section
CAUTION Coupling is Changed	The different STP pump is used after the tuning is performed.	Perform tuning.	Section 4.2.2 Section 3.9.1
CAUTION Different Pump ID	Failure of the SCU-800 or STP pump.	Contact Service office.	
CAUTION PCB is Initialized	Failure of the SCU-800.	Contact Service office.	
CAUTION Pump is Initialized	Failure of the SCU-800 or STP pump.	Contact Service office.	
CAUTION Pump Type is Changed	The STP pump of a different model is used after the tuning is performed.	Perform tuning.	Section 4.2.2 Section 3.9.1
CAUTION Pump&PCB are Initialized	Failure of the SCU-800 or STP pump.	Contact Service office.	
CAUTION PumpType is Mismatch	The inappropriate STP pump is used.	Confirm if the appropriate STP pump is connected.	Section 2.1
CAUTION Tuning Error 1 : : Tuning Error 19	Tuning failure	After turning OFF and ON, perform turning. If the RESET operation does not reset error message, contact Service office.	Section 3.9.1
CAUTION Tuning Not Completed	Turning is not completed.	Perform tuning.	Section 3.9.1
Please contact a service centre	The control parameter is not in the memory of the STP pump.	Contact Service office.	

Table 33 - Error messages at self test state

SCU-800 Control Unit for Turbomolecular Pump

7

MAINTENANCE

7.5.1 Error after self test

If an abnormality/error occurs after the self test, the safety function operates, the "FAILURE" LED and an alarm signal is output from the REMOTE X7 connector (see Table 10). An error message showing the number of the error in the form "Error No. **/**" and the contents of the error are displayed alternately on the lower line of the LCD.

7.5.2 Error messages

The first number of "**/**" is the order of detected errors (the earliest error is number 1) and the second number shows the number of errors that have occurred. Thus, a "1/3" would denote the earliest error of 3 errors. Press the "UP" or "DOWN" switch to scroll through the LCD display menu to view the contents of the next or previous error message. (The "UP" or "DOWN" switch can also be used in REMOTE mode)

Example:

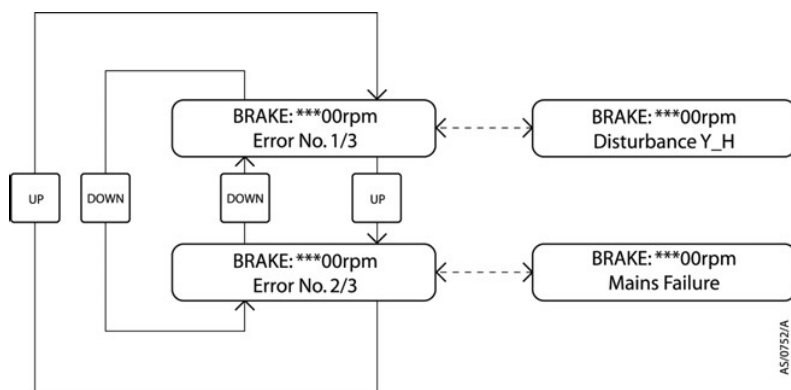

Note: The upper message on the LCD shows the current STP pump operation state. The lower message on the LCD is alternately displayed.

7.5.3 Troubleshooting immediately after power failure occurs

It is recommended to establish a procedure so that the power can be supplied to the SCU-800 immediately after a power recovery.

SCU-800 Control Unit for Turbomolecular Pump

7.5.4 Troubleshooting immediately after other abnormality/errors occur

	<p style="text-align: center;">WARNING</p> <p>When disconnecting cables from the STP pump and/or the SCU-800 to perform troubleshooting and take the necessary action, confirm that the STP pump has stopped, power off the primary power (turn the MAIN POWER "OFF") and isolate (Lockout/Tagout) the electrical energy source water and gas and other energy sources on the vacuum equipment. Failure to do so may result in the inadvertent rotation of the STP pump which may result in an accident, an electric shock or damage to equipment. Moreover, an accident caused by water leaks or gas leak may occur.</p>
---	--

<p style="text-align: center;">CAUTION</p> <p>If the RESET operation does not extinguish the "FAILURE" LED, confirm that the STP pump has stopped, turn OFF the primary power (Switch the MAIN POWER "OFF"), then turn ON the primary power again (turn the MAIN POWER "ON").</p>
--

Refer to Section 4.4.4.

- After confirming the "BRAKE" LED has extinguished and the STP pump stops, remove the probable cause of the abnormality. When the LCD displays an error message, take the necessary action according to Table 34 to Table 40.
- Perform the RESET operation, to turn off the "FAILURE" LED.
- Perform the START operation. Check if the STP pump operates correctly.

SCU-800 Control Unit for Turbomolecular Pump

LCD Messages	Occurrence condition	Pump operation	Probable causes	Countermeasures	Referred section
Aberrant Accel	Rotational speed rises when deteriorating or stopping.	Decelerate and stop, then Touch down. The magnetic bearing output stops and the rotor is descended on the protection bearing.	Atmospheric air flows the STP pump.	Check the vacuum piping system for leakage. Check the exhaust sequence.	
Aberrant Brake	When the rated operation does not stop approx. 30 min. after start operation is executed.	Free run. ¹	Failure of the SCU-800.	Contact Service office.	
Accel Malfunction	Accelerate up to 500 rpm or less.	Stop	1. Malfunction by external noise. 2. Failure of the SCU-800.	1. Turn on the power after resetting. 2. Contact Service office.	
Amp Overcurrent	Excessive magnetic bearing electric current.	Touch down. The magnetic bearing output stops and the rotor is descended on the protection bearing.	Short-circuit or ground fault in the connection cable or at the connector part.	Contact Service office.	
CAUTION: CNT heat ¹	Overheat inside the SCU-800.	Continuance of rotation.	1. High ambient temperature. 2. Insufficient cooling of the SCU-800.	1. Set the ambient temperature to 40 °C (104 °F) or less. 2. Remove obstacle from the ventilation port.	3.4.1 3.4.3
CNT Overheat 1	Overheat inside the SCU-800.	Decelerate and stop.	1. High ambient temperature. 2. Insufficient cooling of the SCU-800.	1. Set the ambient temperature to 40 °C (104 °F) or less. 2. Remove obstacle from the ventilation port.	3.4.1 3.4.3

¹ The driver output stops and the rotor continues rotating by inertia. It may take several hours to stop. To stop the STP pump quickly, close the vacuum valve at the outlet port flange and introduce gas from the purge port into the STP pump.

Table 34 - Error messages after self test

SCU-800 Control Unit for Turbomolecular Pump

LCD Messages	Occurrence condition	Pump operation	Probable causes	Countermeasures	Referred section
Disturbance X_B Disturbance X_H Disturbance Y_B Disturbance Y_H Disturbance Z	Excessive imbalance.	Contact noise and vibration of the rotor are generated from the STP pump. Decelerate and stop.	Abnormal magnetic bearing: 1. Change of the cable length. 2. Disconnection of the STP connection cable or control circuit error. Excessive vibration applied externally to the STP pump: 1. External vibration/impact. 2. Atmospheric air flows into the STP pump. 3. Foreign matter falls into the STP pump.	1. When changing the cable length, perform tuning. 2. Contact Service office.	3.9 Instruction Manual(A)
Driver Com Failure	Failure of serial communication.	Decelerate and stop.	Failure of the SCU-800.	Contact Service office.	
Driver CPU Error	Abnormal CPU operation.	Free run. ^{*1}	Failure of the SCU-800.	Contact Service office.	
Driver Failure	Abnormal driver operation.	Decelerate and stop.	Failure of the SCU-800.	Contact Service office.	
Driver FAN Failure	Cooling fan come to a stop.	Decelerate and stop.	1. Wear-out of the cooling water bearing. 2. Failure of the cooling fan drive circuit.	1. Contact Service office. 2. Contact Service office.	
Driver Overcurrent	Driver over current.	Free run. ^{*1}	1. Short of the STP connection cable. 2. STP pump failure.	1. Contact Service office. 2. Contact Service office.	

^{*1} The driver output stops and the rotor continues rotating by inertia. It may take several hours to stop. To stop the STP pump quickly, close the vacuum valve at the outlet port flange and introduce gas from the purge port into the STP pump.

Table 35 - Error messages after self test (continued)

SCU-800 Control Unit for Turbomolecular Pump

LCD Messages	Occurrence condition	Pump operation	Probable causes	Countermeasures	Referred section
Driver Overload	ACCELERATION state continues for approximately 30 minutes.	Decelerate and stop.	<ol style="list-style-type: none"> High pressure at the inlet port. High pressure at the outlet port. Leakage of the piping system. Failure of the backing-pump. 	<ol style="list-style-type: none"> Use the maximum working pressure or less. Use the allowable backing pressure or less. Check the vacuum piping system for leakage. Check the backing-pump for its capacity and START state. (use a backing-pump with the recommended capacity or more) 	Instruction Manual(B)
Driver Overvoltage	Driver overvoltage.	Free run. ^{*1}	Failure of the SCU-800.	Contact Service office.	
Driver PWM Trouble	Failure of the driver circuit.	Free run. ^{*1}	Failure of the SCU-800.	Contact Service office.	
DSP Initialize Fail	Abnormal CPU operation.	Touch down. The magnetic bearing output stops and the rotor is descended on the touch down bearing.	Failure of the SCU-800.	Contact Service office.	
DSP->PCB Com Fail	Serial communication failure.	Decelerate and stop.	Failure of the SCU-800.	Contact Service office.	
E.valve disconnect	Disconnection of the emergency valve cable.	Decelerate and stop.	<ol style="list-style-type: none"> Disconnection of the emergency vent valve cable. Incorrect setting of the emergency vent valve. 	<ol style="list-style-type: none"> Connect the cable correctly. If the cable is not locked, lock it securely. Set "Leak Valve Option" to "DISABLE". 	3.11

^{*1} The driver output stops and the rotor continues rotating by inertia. It may take several hours to stop. To stop the STP pump quickly, close the vacuum valve at the outlet port flange and introduce gas from the purge port into the STP pump.

Table 36 - Error messages after self test (continued)

SCU-800 Control Unit for Turbomolecular Pump

LCD Messages	Occurrence condition	Pump operation	Probable causes	Countermeasures	Referred section
Inordinate Current	Excessive magnetic bearing electric current continues for 30 sec.	Touch down. The magnetic bearing output stops and the rotor is descended on the touch down bearing.	1. Failure of the STP pump. 2. Failure of the SCU-800.	1. Contact Service office. 2. Contact Service office.	
Insufficient Supply	Connection of the STP pump not corresponding to the input power supply (100V).	Touch down. The magnetic bearing output stops and the rotor is descended on the touch down bearing.	Incorrect connection of the input power supply.	Change the AC input voltage 200V.	
M_Temp Sensor Lost	Disconnection of the temperature sensor of the STP pump.	Decelerate and stop.	Failure of the STP pump.	Contact Service office.	
Mains Failure	Insufficient power supply.	Decelerate and stop.	1. Power failure. 2. Incorrect connection of the power cable. 3. Failure of the power cable. 4. Insufficient power supply voltage.	1. Check whether or not a power failure has occurred. 2. Connect the power cable correctly. 3. Replace the power cable. 4. Set the voltage to the rated voltage±10%.	7.1.1 3.6.3 Section 3.6.3 Section 2.1
Motor Overheat	Overheating inside the STP pump.	Decelerate and stop.	1. Overheating during baking. 2. Insufficient cooling. 3. Leakage of the vacuum piping system. 4. Repetition start/stop operations.	1. Set the temperature of the baking heater to 120 °C (248 °F) or less. 2. At the time of baking or gas pumping, always cool the STP pump. 3. Check the piping system for leakage. 4. Repetitions start/stop operations may cause the STP pump to overheat.	Instruction manual(B) Instruction manual(B) 4.1.1 4.1.2

Table 37 - Error messages after self test (continued)

SCU-800 Control Unit for Turbomolecular Pump

LCD Messages	Occurrence condition	Pump operation	Probable causes	Countermeasures	Referred section
Motor Resistor Lost	Motor resistance measurement is impossible.	Stop, rotation is inoperative.	Failure of the SCU-800.	Contact Service office.	
Overspeed 1 Overspeed 2 Overspeed 3	Rotational speed exceeds rated speed.	Breaker OFF. Decelerate and stop.	Failure of the SCU-800.	Contact Service office.	
P.Cable Disconnected	Disconnection of the STP connection cable.	Touch down. The magnetic bearing output stops and the rotor is descended on the touch down bearing.	1. Incorrect connection of the STP connection cable. 2. Failure of the STP connection cable.	1. Connect the cable correctly. If the cable is not locked, lock it securely. 2. Contact Service office.	3.6.1
PCB Record Failure	Failure of record in memory.	Decelerate and stop.	Failure of the SCU-800.	Contact Service office.	
PCB->DSP Com Fail	Failure of serial communication.	Decelerate and stop.	Failure of the SCU-800.	Contact Service office.	
Power Supply Failure	Abnormal power circuit.	Decelerate and stop.	Failure of the SCU-800.	Contact Service office.	
Pump Record Failure	Failure of record in memory.	Decelerate and stop.	Failure of the STP pump.	Contact Service office.	
Ram Error	Abnormal memory.	Decelerate and stop.	Failure of the SCU-800.	Contact Service office.	
R-Unit Com Failure	Failure of serial communication.	Decelerate and stop.	Failure of the SCU-800.	Contact Service office.	
R-Unit Failure	Abnormal board connection.	Decelerate and stop.	Failure of the SCU-800.	Contact Service office.	
Second Damage Limit	When the extent of the damage on the touch down bearing exceeds the second damage limit.	Decelerate and stop.	Frequency of "Disturbance" or "Mains Failure" error.	Overhaul is needed. Contact Service office.	

Table 38 - Error messages after self test (continued)

SCU-800 Control Unit for Turbomolecular Pump

LCD Messages	Occurrence condition	Pump operation	Probable causes	Countermeasures	Referred section
Speed Pulse Lost	Abnormal rotational speed detection.	Free run ^{*1}	1. STP pump failure. 2. Failure of the SCU-800.	1. Contact Service office. 2. Contact Service office.	
START NOT ALLOWED	"Second Damage Limit" occurs.	Rotation is inoperative.	Frequency of "Disturbance" or "Mains Failure" error.	Overhaul is needed. Contact Service office. Set "Warning Damage Point" to "DISABLE" to release the error and continue operation temporarily.	Section 7.3.3 and 3.12
T. Cable Disconnect	TMS connection cable is not connected when the state "TMS Function" is set to "ENABLE".	Decelerate and stop.	1. Disconnection of the TMS connection cable. 2. Failure of the TMS connection cable. 3. Incorrect setting of the TMS function.	1. Connect the cable correctly. If the cable connector is not locked, lock it securely. 2. Contact Service office. 3. When the TMS function is not in use, set the TMS function to "DISABLE".	Section 3.6.2 Section 3.11.3
TMS Higher Temp	TMS temperature control error (when the TMS unit detection temperature becomes higher than the setting value by 10°C (+18°F) or more.	Decelerate and stop.	1. Cooling failure of TMS unit. 2. Failure of TMS unit.	1. Connect the electromagnetic cooling water valve correctly. Check the volume of water and water temperature. 2. Contact Service office.	Instruction manual(B)

*1 The driver output stops and the rotor continues rotating by inertia. It may take several hours to stop. To stop the STP pump quickly, close the vacuum valve at the outlet port flange and introduce gas from the purge port into the STP pump.

Table 39 - Error messages after self test (continued)

SCU-800 Control Unit for Turbomolecular Pump

LCD Messages	Occurrence condition	Pump operation	Probable causes	Countermeasures	Referred section
TMS Lower Temp	TMS temperature control error (when the TMS unit detection temperature becomes lower than the setting value by 10°C (-18 °F) or more. Error is not detected for a certain time after the STP pump starts.	Decelerate and stop.	1. Failure of the TMS heater. 2. Failure of the TMS unit.	1. Contact Service office. 2. Contact Service office.	Instruction manual(B)
TMS Sensor Lost	TMS sensor is not connected when the state "TMS Function" is "ENABLE".	Decelerate and stop.	1. Disconnection of the TMS sensor. 2. Incorrect setting of the TMS function. 3. Disconnection of the TMS connection cable. 4. Failure of the TMS connection cable.	1. Contact Service office. 2. When the TMS function is not in use, set the TMS function to "DISABLE". 3. Connect the cable correctly. If the cable connector is not locked, lock it securely. 4. Contact Service office.	3.11.3 3.6.2
Tuning Error 1 : : Tuning Error 19	Tuning failure.	Touch down. The magnetic bearing output stops and the rotor is descended on the touch down bearing.	1. Failure of the STP pump. 2. Failure of the SCU-800.	1. Perform tuning after power ON/OFF operation. 2. When the error is displayed after tuning, contact Service office.	3.9.1

Table 40 - Error messages after self test (continued)

SCU-800 Control Unit for Turbomolecular Pump

7.6 When error message is not displayed on LCD

When the "FAILURE" LED illuminates and the LCD displays an error message, refer to Table 33 to Table 40.

7.6.1 Abnormalities when powering ON

No.	Symptom	Probable cause	Countermeasures	Referred section
1	The "POWER" LED does not illuminate.	Incorrect connection of power cable.	Connect the power cable correctly.	Section 3.6.3
		Abnormal power voltage.	Set the voltage to rated voltage \pm 10%.	Section 2.1 Section 3.6.3
		Power failure.	Check if a power failure has occurred.	Section 7.1.1

Table 41 - Troubleshooting when powering ON

7.6.2 Abnormalities when performing rotational operation

No.	Symptom	Probable causes	Countermeasures	Referred section
1	The "ACCEL." LED does not illuminate.	The "MANUAL/ REMOTE" changeover switch is not in the correct position.	Slide the "MANUAL/ REMOTE" changeover switch to the correct position.	Section 3.2 Section 4.4 Section 4.5
		Rotation INHIBIT signal input pins (REMOTE X7 (1)-(5)) are open.	When not using this function, short the circuit between (1)-(5), or set "Inhibit Command" to "DISABLE". If these pins are open, the STP pump will not rotate after performing the start operation.	Section 4.5.1 Section 3.11

Table 42 - Troubleshooting when performing the STP pump start operation

SCU-800 Control Unit for Turbomolecular Pump

7.6.3 Other abnormalities

No.	Symptom	Probable causes	Countermeasures	Referred section
1	The STP pump stops.	Rotation INHIBIT signal input pins (REMOTE X7 (1)-(5)) are open.	When not using this function, short the circuit between (1)-(5), or set "Inhibit Command" to "DISABLE". If these pins are open, the STP pump will not rotate after performing the start operation.	Section 4.5.1 Section 3.11
2	The TMS unit does not function.	Incorrect settings of TMS function.	When using the TMS unit, set "TMS Function" to "ENABLE".	Section 3.11
3	Rotation INHIBIT signal does not function correctly.	Incorrect settings of inhibit function.	When using the rotation INHIBIT signal, set "Inhibit Command" to "ENABLE".	Section 3.11

Table 43 - Troubleshooting while the STP pump is rotating

7.7 "Error Record" message display function

The SCU-800 can display the contents of up to the last 10 errors on the LCD.

To view the error record, press the "SELECT" switch several times (refer to Section 3.10).

The error number of up to the last 10 errors is displayed on the upper line of the LCD in the form "Error Record n **/", and the error message is displayed on the lower line.

The first number of "**/**" shows the order of detected errors (the most recent error is number 1) and the second number shows the number of errors that have occurred up to 10. Thus, a "1/3" would denote the most recent error out of 3. Press the "UP" or "DOWN" switch to scroll through the list and display the contents of the next or previous error message in the error record. The date of the detected error is displayed as long as "ENTER" switch is pressed. (The "UP", "DOWN" and "ENTER" switch can also be used in Remote Mode, refer to Section 3.10.)

SCU-800 Control Unit for Turbomolecular Pump

7.8 Maintenance and inspection

	<p>WARNING</p> <p>Before carrying out any maintenance or inspections on the STP pump and/or the SCU-800, power off the primary power (turn the MAIN POWER "OFF"), confirm that the LED and LCD are extinguished, and isolate (Lockout/Tagout) the electrical energy source, water and gas, and other energy sources on the vacuum equipment. Failure to do so may result in the inadvertent rotation of the STP pump which may result in an accident, an electric shock or damage to equipment. Moreover, an accident caused by water leaks or gas leak may occur.</p>
---	---

	<p>WARNING</p> <p>DO NOT remove the connector while the pump is rotating. The voltage might be output to connector according to the rotational speed, and it causes the electric shock or the failure.</p>
---	---

<p>CAUTION</p> <p>DO NOT touch any place other those specified when performing maintenance or inspecting the pump and NEVER open any panel because it could cause shock, malfunction, or short circuit.</p>
--

Power OFF the peripheral equipments such as a baking heater before performing maintenance and inspections.

Only Edwards will replace the maintenance parts and will execute repair and overhaul. Contact Service office.

7.8.1 Replacing the fuses

<p>CAUTION</p> <p>Remove the probable causes of the blown fuse (Ex. a ground fault of TMS heater, etc.) before replacing the fuse. Always use specified and rated fuses.</p>

Protection fuses F1 and F2 for TMS (optional accessory) are equipped to the rear panel of the STP control unit. (F1, F2 rating: 4A, 250V, 5×20mm, Fast Acting, 217 004 Littelfuse)

Note: If fuses are blown frequently even after they are replaced, contact us.

SCU-800 Control Unit for Turbomolecular Pump

7

MAINTENANCE

7.8.2 Cleaning

The method of cleaning the SCU-800 is shown below.

- Clean the outside of the SCU-800 with a dry wipe as required.
- When dust has accumulated in the ventilation port, wipe off or vacuum it with the cleaner. In this case, dust must not enter in the SCU-800.
- Clean off with a pure gas when dust has accumulated in the connector.
- When the label of the SCU-800 has been damaged, contact Service office.

7.8.3 Overhaul

The air-cooling fan used in the SCU-800 will deteriorate after long-term use. It is recommended to overhaul the SCU-800 once every two or three years as a target. This overhaul includes inspection and cleaning. Overhaul costs will be at your own charge. The costs of parts that need to be replaced because of deterioration or abrasion will be at your own charge. When overhaul of the SCU-800 is needed, contact Service office.

8 STORAGE, TRANSPORTATION AND DISPOSAL

8.1 Storage of the SCU-800

When planning not to use the SCU-800 over a long period (more than a few months), follow the precautions below:

1. Store the SCU-800 in a horizontal position.
2. DO NOT store the SCU-800 in the following areas:
 - Areas of high humidity, (if it must be stored in a place of high humidity, insulate it from the outside and use a dehumidifying agent.)
 - Areas prone to temperature extremes. High temperatures of no more than + 55 °C (131 °F), and low temperatures of less than –25 °C (13 °F).
 - Areas which will be subjected to direct sunlight.
 - Areas where corrosive gases may exist.
 - Areas subjected to water/dampness.
 - Areas subjected to excessive dust.
 - Areas with insufficient ventilation.
 - Areas subjected to strong magnetic and electric fields or radiation.
 - Areas subjected to electric noise and vibration.

8.1.1 Transporting for repair or overhaul

	WARNING Ensure you follow the "Return Procedure" to prevent an accident during the transportation, repair or overhaul.
---	--

CAUTION Edwards will not be responsible for any damage or problems that may occur when returning the SCU-800.

Always contact Service office before returning the SCU-800 for repairs, overhaul or other purposes.

When returning the SCU-800 to Service office, use the original packing to prevent external damage. If you do not have the original packing, use similar or superior packaging material.

"Return Procedure" and the "Malfunction Information" are in the end of the Instruction Manual. When additional sheet is needed, contact Service office.

Note: When returning the SCU-800 to Service office, fill in the necessary items in the "Return Declaration" and fax it to Service office.

SCU-800 Control Unit for Turbomolecular Pump

8.2 Disposal

Dispose of the SCU-800 as industrial waste in accordance with all local and national safety and environmental standards.

Note: Edwards will not be responsible for problems during or after disposal.

9 SERVICE, SPARES AND ACCESSORIES

9.1 Introduction

Edwards products, spares and accessories are available from Edwards companies and from a network of distributors, which are listed on the last page of this document. A majority of these centres employ Service Engineers who have undergone comprehensive Edwards training courses. Order spare parts and accessories from your nearest Edwards company or distributor. When you order, state for each part required:

- Model and parts number of your STP pump
- Serial number (if any)
- Item number and description of part

9.2 Service

Edwards products are supported by a world-wide network of Edwards Service office. Each Service office offers a wide range of options including: equipment decontamination; service exchange; repair; rebuild and testing to factory specifications. Equipment, which has been serviced, repaired or rebuilt, is returned with a full warranty.

Your local Service office can also provide Edwards engineers to support on-site maintenance, service or repair of your equipment.

For more information about service options, contact your nearest Service office or Edwards.

9.3 Spares

Air-cooling fan: When exchanging, contact Service Office. Air-cooling fan should be replaced in Service office.

The possession periods of maintenance parts is for at least 7 years after the products is discontinued.

Contact Service office, when replacement is required.

SCU-800 Control Unit for Turbomolecular Pump

9.4 Accessories

The following is a list of accessories that can be purchased by contacting Edwards.

Items	Application purpose	Remarks
Instruction Manual (A) ^{*1}	Generic Instruction Manual	Supplied with STP pump
Instruction Manual (B) ^{*1}	Pump Specific Information	Supplied with STP pump
Instruction Manual (C) ^{*1}	Control unit Instruction Manual applicable to your STP pump	This manual Supplied with STP control unit
STP pump	STP pump	Refer to the STP pump Instruction Manual (B) for the applicable STP control unit.
Power cable	Primary input power	Standard cable length is 5 m. 10 m and 20 m versions are available. Contact Edwards for further information.
STP connection cable	Connection cable between the STP pump and the STP control unit	Standard cable length is 5m. 10 m and 20 m versions are available. Contact Edwards for further information.
TMS unit ^{*2}	Control the STP pump temperature	Except STP-603/1003 series
Air-cooling unit ^{*2}	For cooling the STP pump	
Baking heater ^{*2}	For baking the STP pump	

^{*1} STP pump consists of the three-volumed Instruction Manuals.

^{*2} Optional accessory