

# Instruction Manual

## iGX Dry Pumping Systems



Description	Description
iGX100L 200 V - 230 V 50/60 Hz	A546-10-958
iGX100L 380 V - 460 V 50/60 Hz	A546-10-959
iGX100L 200 V - 230 V 50/60 Hz SS	A548-10-958
iGX100L 380 V - 460 V 50/60 Hz SS	A548-10-959
iGX600L 200 V - 230 V 50/60 Hz	A546-30-958
iGX600L 380 V - 460 V 50/60 Hz	A546-30-959
iGX600L 200 V - 230 V 50/60 Hz SS	A548-30-958
iGX600L 380 V - 460 V 50/60 Hz SS	A548-30-959
iGX100N 200 V - 230 V 50/60 Hz	A546-11-958
iGX100N 380 V - 460 V 50/60 Hz	A546-11-959
iGX100N 200 V - 230 V 50/60 Hz SS	A548-11-958
iGX600N 200 V - 230 V 50/60 Hz	A546-31-958
iGX600N 380 V - 460 V 50/60 Hz	A546-31-959

Description	Description
iGX1000N 200 V - 230 V 50 Hz	A546-81-958
iGX1000N 380 V - 460 V 50 Hz	A546-81-959
iGX1000N 200 V - 230 V 50/60 Hz SS	A548-81-958
iGX100M 200 V - 230 V 50/60 Hz	A546-12-958
iGX100M 380 V - 460 V 50/60 Hz	A546-12-959
iGX100M 200 V - 230 V 50/60 Hz SS	A548-12-958
iGX100MTi 200 V - 230 V 50/60 Hz	A546-48-958
iGX100MTi 380 V - 460 V 50/60 Hz	A546-48-959
iGX100MTi 200 V - 230 V 50/60 Hz SS	A548-48-958
iGX600M 200 V - 230 V 50/60 Hz	A546-32-958
iGX600M 380 V - 460 V 50/60 Hz	A546-32-959
iGX600M 200 V - 230 V 50/60 Hz SS	A548-32-958

# Declaration of Conformity

We,



declare under our sole responsibility that the product(s):

iGX100L 200-230V 50/60Hz	A546-10-958	iGX100N 200-230V 50/60Hz	A546-11-958	iGX100M 200-230V 50/60Hz	A546-12-958
iGX100L 380-460V 50/60Hz	A546-10-959	iGX100N 380-460V 50/60Hz	A546-11-959	iGX100M 380-460V 50/60Hz	A546-12-959
iGX100L 200-230V 50/60Hz SS	A548-10-958	iGX100N 200-230V 50/60Hz SS	A548-11-958	iGX100M 200-230V 50/60Hz SS	A548-12-958
iGX100 380-460V 50/60Hz SS	A548-10-959	iGX600N 200-230V 50/60Hz	A546-31-958	iGX100MTi 200-230V 50/60Hz	A546-48-958
iGX600L 200-230V 50/60Hz	A546-30-958	iGX600N 380-460V 50/60Hz	A546-31-959	iGX100MTi 380-460V 50/60Hz	A546-48-959
iGX600L 380-460V 50/60Hz	A546-30-959	iGX1000N 200-230V 50/60Hz	A546-81-958	iGX100MTi 200-230V 50/60Hz SS	A548-48-958
iGX600L 200-230V 50/60Hz SS	A548-30-958	iGX1000N 380-460V 50/60Hz	A546-81-959	iGX600M 200-230V 50/60Hz	A546-32-958
iGX600L 200-230V 50/60Hz SS	A548-30-959	iGX1000N 200-230V 50/60Hz SS	A548-81-958	iGX600M 380-460V 50/60Hz	A546-32-958
				iGX600M 200-230V 50/60Hz SS	A548-32-958

to which this declaration relates is in conformity with the following standard(s) or other normative document(s):

EN1012-2 (1997)	Compressor and Vacuum Pumps Safety Requirements; Part 2 - Vacuum Pumps.
EN61010-1 (2001)	Safety Requirements for Electrical Equipment for Measurement, Control and Laboratory Use; Part 1 - General Requirements.
EN61326 (1998 + A2:2001)	Electrical Equipment for Measurement, Control and Laboratory Use - EMC Requirements (Industrial locations immunity - Class A equipment emissions).

when installed in accordance with the instruction manual supplied with the pump,



following the provisions of:

73/023/EEC	Low Voltage Directive.
89/336/EEC	Electromagnetic Compatibility Directive.
98/37/EC	Machinery Safety Directive.

*This product has been manufactured under a quality system registered to ISO9001*

**Product Manual Addendum - Equipment types:**

iH Vacuum Pump Range	GX Vacuum Pump Range	DiHxK Vacuum Pump Range
iF Vacuum Pump Range	iHxK Vacuum Pump Range	DiFxK Vacuum Pump Range
iGX Vacuum Pump Range	iFxK Vacuum Pump Range	EPX Vacuum Pump Range
IPX Vacuum Pump Range	iQ/QDP/QMB Vacuum Pump Ranges	iL Vacuum Pump Range

Product Label	Overshipper Label	Pallet Marking
	 CB	 NW
Indicates toxic or hazardous substance contained in at least one of the homogeneous materials used for this part is above the limit requirement in SJ/T11363-2006. Environmental Protection Period is 20 years	Recyclable Cardboard	Recyclable Natural Wood

**Materials Content Declaration & Environmental Protection Use Period**

The Chinese regulatory requirement on the Control of Pollution Caused by Electronic Information Products No. 39 (also known as 'China RoHS') mandates that manufacturers of certain categories of electronic products sold in China after 1st March 2007 –

- Mark the product and packaging
- Define the Product's Environment Protection Use Period (EPUP)
- Provide a Materials Content Declaration.

**Environmental Protection Use Period (EPUP)**

This is the period in years during which the toxic or hazardous substances or elements contained in this product will not leak or mutate under normal operating conditions so that the use of such electronic information products will not result in any severe environmental pollution, any bodily injury or damage to any assets.

The Environmental Protection Use Period is **20** years for this product.

For the purposes of EPUP, normal operating conditions are considered to be use in accordance with the product's instruction manual.

**Materials Content Declaration**

Part name	Toxic or Hazardous Substances and Elements					
	Lead (Pb)	Mercury (Hg)	Cadmium (Cd)	Hexavalent Chromium (Cr (VI))	Poly brominated biphenyls (PBB)	Poly brominated diphenyl ethers (PBDE)
Cartridge	○	○	x	x	○	○
Enclosure	○	○	x	x	○	○
Electronics and Controls	X	○	x	x	○	○
Cooling System	○	○	x	x	○	○
Purge System	○	○	x	x	○	○
○: Indicates that this toxic or hazardous substance contained in all of the homogeneous materials for this part is below the limit requirement in SJ/T11363-2006. X: Indicates that this toxic or hazardous substance contained in at least one of the homogeneous materials used for this part is above the limit requirement in SJ/T11363-2006.						

Note 1. Table applies to all product types listed above.

# Contents

Section	Page
<b>1 Introduction</b> .....	<b>1</b>
1.1 Scope and definitions .....	1
1.2 Applications .....	2
1.3 The iGXL system .....	2
1.4 Priority of control .....	4
1.5 Active utility control .....	5
<b>2 Technical Data</b> .....	<b>7</b>
2.1 General technical data .....	7
2.2 Electrical Data .....	8
2.3 Loading .....	8
2.4 Connections .....	9
2.5 General Data .....	10
<b>3 Installation</b> .....	<b>11</b>
3.1 Locate the dry pumping system .....	12
3.2 Lubrication .....	13
3.3 Connect the iGX system to your vacuum/exhaust system and interstage connection (if fitted) .....	13
3.4 Connect to your factory extraction system (optional) .....	14
3.5 Connect the nitrogen supply (if provided) .....	14
3.5.1 Flammable/pyrophoric materials .....	14
3.5.2 Gas Purges .....	15
3.6 Leak-test the iGX system .....	15
3.7 Connect the electrical supply .....	16
3.8 Connect an additional RF earth (ground) (optional) .....	18
3.9 Connect to your emergency stop circuit .....	18
3.10 Connect the cooling-water hoses .....	19
3.11 Accessories .....	19
3.12 Commission the iGX system .....	20
3.13 Install additional safety equipment .....	22
<b>4 OPERATION</b> .....	<b>23</b>
4.1 Start-up .....	23
4.2 Status indicators .....	24
4.3 Manual shut-down .....	24
4.4 Automatic shut-down .....	25
4.5 Unplanned shutdown and alarms .....	25
4.6 Emergency stop .....	25
4.7 Restart the pump after an emergency stop or automatic shut-down .....	26
4.8 Single equipment monitor (SEM) .....	26
<b>5 MAINTENANCE</b> .....	<b>27</b>
5.1 Safety and maintenance frequency .....	27
5.2 Relocate the system for maintenance .....	28
5.3 Draining the cooling-water .....	29
5.4 Cleaning the pump .....	30
<b>6 TRANSPORTATION, STORAGE AND DISPOSAL</b> .....	<b>31</b>
6.1 Transportation .....	31
6.2 Storage .....	31

6.3	Disposal .....	31
7	<b>SERVICE, SPARES AND ACCESSORIES .....</b>	<b>33</b>
7.1	Introduction .....	33
7.2	Service .....	33
7.3	Ordering accessories .....	34

For return of equipment, complete the HS Forms at the end of this manual.

## Illustrations

<b>Figure</b>		<b>Page</b>
1	iGX Applications chart .....	2
2	The controls/connectors .....	3
3	The rear status panel LED indicators .....	4
4	The front panel controls .....	4
5	Priority of control .....	5
6	Centre of gravity and levelling foot loads .....	8
7	System arrangement to reduce effective footprint (if required) .....	12
8	High and low volt coding pin arrangement .....	17
9	Method for connecting phase wires .....	18
10	Connections to emergency stop circuit (systemable) .....	18
11	Installing 3/8" quick connect fittings (provided) .....	20
12	Gas module access panel .....	21
13	Flow tube (14 slm) .....	21
14	Flow tube (4 slm) .....	22

## Tables

Table	Page
1 Technical data .....	7
2 Technical data .....	7
3 Electrical data .....	8
4 Centre of gravity and levelling foot loads (Refer to <a href="#">Figure 6</a> ) .....	8
5 iGX connector types .....	9
6 Technical data .....	10
7 Safety sensors .....	25
8 Accessories .....	34

## Associated publications

Publication title	Publication number
Vacuum pump and vacuum system safety	P300-20-000

# 1 Introduction

## 1.1 Scope and definitions

This manual provides installation, operation and maintenance instructions for the Edwards iGX dry pumping systems. You must use your pump as specified in this manual.

Read this manual before you install and operate your pump. Important safety information is highlighted as WARNING and CAUTION instructions; you must obey these instructions. The use of WARNINGS and CAUTIONS is defined below.



### WARNING

Warnings are given where failure to observe the instruction could result in injury or death to people.

### CAUTION

Cautions are given where failure to observe the instruction could result in damage to the equipment, associated equipment and process.

The units used throughout this manual conform to the SI international system of units of measurement in accordance with the recommendations of IEC1010, the following warning labels are on the pump:



Warning - refer to accompanying documentation.



Warning - risk of electric shock.



Warning - hot surfaces.



Warning - moving parts present.



Warning - heavy object.



Warning - pressurised.



RF earth (ground).



PE Protective earth (ground).



Warning - use protective equipment.



Warning - Risk of explosion.

The Pressurised and Risk of explosion warnings only appear in this manual.

Material Safety Data Sheets for chemicals supplied by Edwards can be obtained by contacting Edwards.

## 1.2 Applications

If you use the iGX system on an application for which it is not suitable (refer to [Figure 1](#)), you may invalidate your warranties. If in doubt, contact Edwards who will advise you as to the suitability of the iGX system for any particular application.

Figure 1 - iGX Applications chart

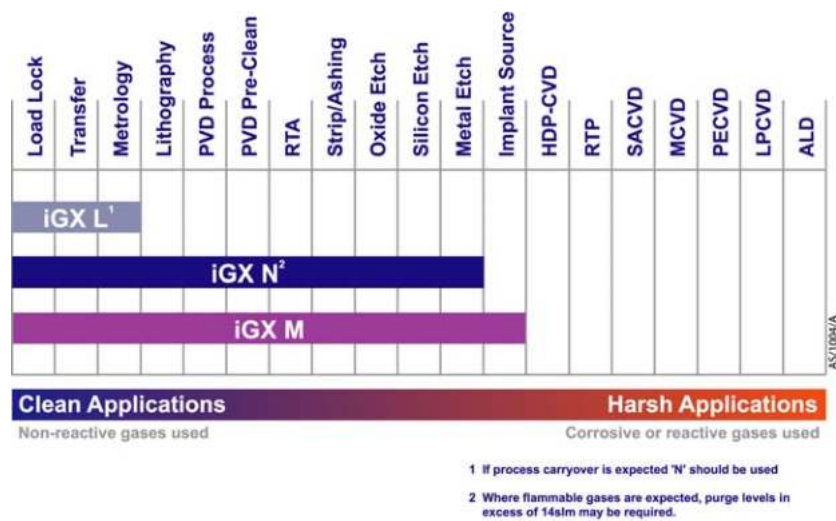

## 1.3 The iGXL system

Pumping a chemical that will attack the materials in contact with these process materials may, over time, result in the internal contents of the pump becoming exposed to the external environment, which may constitute a safety hazard. If in doubt, contact Edwards who will advise you as to the suitability of this pump for any particular application.

It is also a feature of this pump design that process gases are contained within the gearbox. This pump is not suitable for use with flammable, hazardous, toxic or corrosive gases or material.



Figure 2 - The controls/connectors

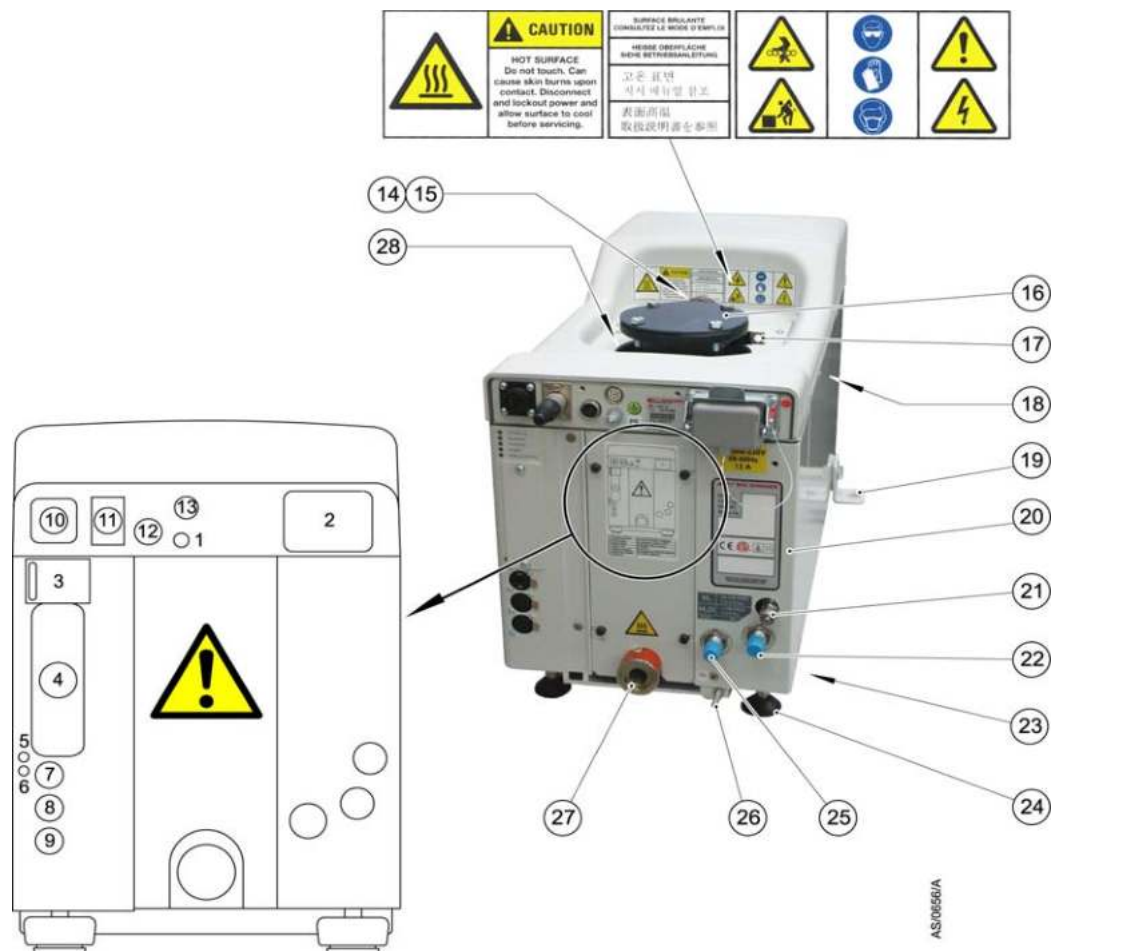

Item	Control/connector identification	Item	Control/connector identification	Item	Control/connector identification	Item	Control/connector identification
1	Protective earth (ground) M5	8	Comms 2 - LON module connection	15	Lifting eyebolt	22	Cooling-water supply connection
2	Electrical supply connection	9	Comms 1 - System control/PDT 2 connection	16	Pumped gas inlet connection	23	Castors (3 off)
3	Rear status panel	10	Gate valve interface (EMO on T variant)	17	RF earth (ground) cable	24	Levelling feet (4 off)
4	Comms 4 - MicroTIM connection (if fitted)	11	Accessory module interface*	18	Interstage connection (if fitted)	25	Cooling-water return connection
5	Ethernet active LED	12	GRC interface*	19	Seismic bracket (if fitted, 4 off)	26	RF earth (ground) stud M6
6	Ethernet installed LED	13	Extraction port	20	Gas Module access panel	27	Exhaust gas outlet connection
7	Comms 3 Ethernet connection	14		21	Nitrogen purge port	28	Leak-test port

\* not on T variants

Figure 3 - The rear status panel LED indicators

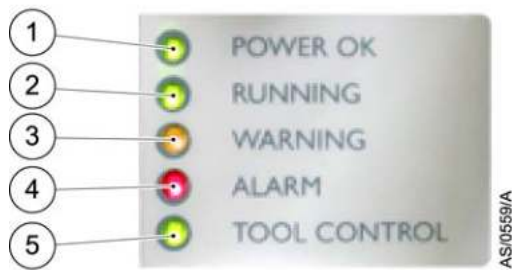

Item	Indication
1	Power OK (green)
2	Running (green)
3	Warning (Amber)
4	Alarm (Red)
5	Tool control (Green)

Figure 4 - The front panel controls



Item	Indication	Item	Indication
1	EMS button*	6	Alarm LED (red)
2	Start button	7	Warning LED (amber)
3	Stop button	8	Running LED (green)
4	AUC LED (green)	9	Power OK LED (green)
5	Local control button/LED (green)	10	Comms 5 pump display terminal (PDT 1) connection

\* Not on T variants

## 1.4 Priority of control

The iGX system can be controlled by a number of modules: the Pump Display Terminal (PDT), from the tool through the MicroTIM, or from the front panel local control membrane (refer to Figure 4). Only one of these can have control of the iGX system at any one time. That is, once one of these has control of the iGX system, control requests from the other are denied.

The PDT indicates who is in control. LEDs are also provided on the rear panel, front panel or PDT, which illuminate to indicate 'in control'. Please refer to Figure 5.

## 1.5 Active utility control

Active Utility Control (AUC) is available on the iGX system. This function reduces the power of the iGX system while on stand-by. The power reduction is achieved by reducing the rotational speed of the iGX pump. This function also reduces the nitrogen purge of M variant systems while in stand-by mode.

Advanced Active Utility Control (AAUC) is also available. This function, in addition to AUC, can reduce the water flow of the iGX system while on stand-by, therefore allowing further reductions in power. Contact Edwards for advice.

The AUC functionality is controlled by the on/off process signal from the Tool Interface Module (TIM).

Figure 5 - Priority of control

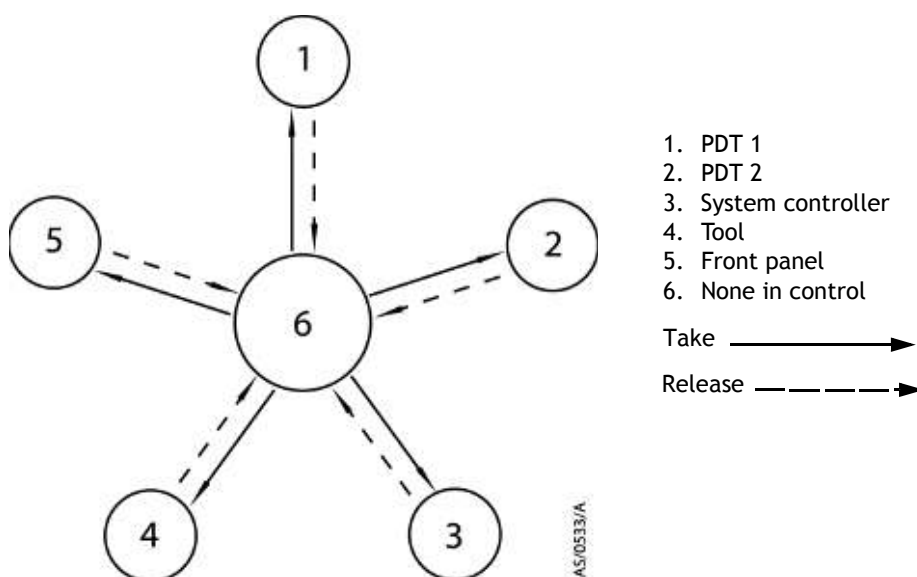

## 2 Technical Data

### 2.1 General technical data

**Table 1 - Technical data**

Type	Characteristics	100	300	600	1000	Units
General	Dimensions (L x W x H)*	695 x 280 x 395	695 x 280 x 695	695 x 280 x 695	695 x 280 x 695	mm
	Mass (excluding packaging)	120	200	220	230	kg
	Noise level (at ultimate)†	< 60	< 55	< 55	< 55	dB(A)
	Vibration level at inlet	< 1.5	< 1.5	< 1.5	< 1.5	mm s <sup>-1</sup>
	Vibration to the floor (when docked)	< 0.05	< 0.05	< 0.05	< 0.05	mm s <sup>-1</sup>
	Initial force to push the pump	0.06	0.09	0.10	0.11	kN
	Sustained force to push the pump	0.04	0.06	0.07	0.07	kN
	Warm up time to nominal pumping performance	15	15	15	15	minute s
	Minimum warm up time to process gas pumping	2	2	2	2	hours
Performance	Typical to peak pumping speed (no gas purge/cold pump)	100	300	600	800	m <sup>3</sup> h <sup>-1</sup>
	Ultimate (shaft seal purge only)	0.005	0.0007	0.0007	0.0007	mbar
Water-cooling system	Minimum flow rate required	1	2	2	2	l min <sup>-1</sup>
	Typical heat removed from the system	1	1.6	1.6	1.7	kW
Connections	Pump inlet flange (bolted)	ISO63	ISO63	ISO100	ISO100	
	Exhaust gas outlet	NW25	NW25	NW25	NW25	
	Extraction port	50	50	50	50	mm dia

\* Refer to Web for installation drawings

† Check valve accessory fitted

**Table 2 - Technical data**

Type	Characteristics	L	N	M	Units
Gas system	Nitrogen supply pressure range		2.5 to 6.9	2.5 to 6.9	bar gauge
	Stability of supply		± 1.4	± 1.4	bar gauge
	Nitrogen supply quality		<0.01	<0.01	µm
	Nitrogen flow rate		14	44	slm
	Gas module pressure		2	2	bar gauge
	Pressure transducer accuracy			± 0.04 @ 0.41	bar gauge
	Mass flow transducer accuracy			± 4.3	slm
Interstage (I)	Peak pumping speed, interstage	25		25	m <sup>3</sup> h <sup>-1</sup>
	Ultimate, interstage	0.1		0.5	mbar
	Pump interstage flange	NW16		NW16	

## 2.2 Electrical Data

Table 3 - Electrical data

Supply voltage and frequency	200/230 50/60 Hz				380/460 50/60Hz			
	100	300	600	1000	100	300	600	1000
Full load (A)	12	22	22	22	8	14	14	14
Booster motor rating (kW)		1.9	1.9	1.9		1.9	1.9	1.9
Pump motor rating (kW)	1.9	1.9	1.9	1.9	1.9	1.9	1.9	1.9

## 2.3 Loading

Table 4 - Centre of gravity and levelling foot loads (Refer to Figure 6)

		100	300	600	1000
Centre of gravity	A	510	510	510	510
	B	246	266	243	243
	C	103	107	108	108
	D	216	216	216	216
	E	167	287	311	310
Levelling foot loads	1	26	45	56	56
	2	35	58	55	55
	3	28	43	61	61
	4	31	54	48	48

Figure 6 - Centre of gravity and levelling foot loads

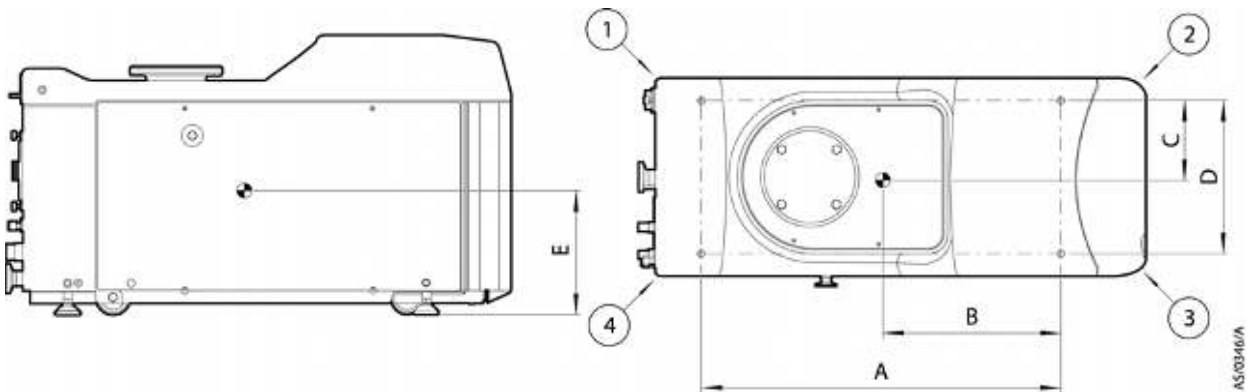

## 2.4 Connections

Table 5 - iGX connector types

Description	Mating connector description/ external supply rating	Internal supply rating
PDT1	XLR type 5-way plug	24 V d.c. 0.75 A
Mains connection	Weidmuller HDC 16D free socket, PG21, 6 mm <sup>2</sup> stranded wire, 13-18 mm cable OD	
Ethernet connection	Standard RJ45 type or Neutrik Ethercon RJ45	IEE802.3 10BaseT Ethernet
LON module connection	XLR type 4-way plug	24 V d.c. 0.75 A
PDT2	XLR type 5-way plug	24 V d.c. 0.75 A
Gate valve interface*	CPC 9-way plug, standard gender, socket contacts	24 V d.c. (48 V peak), 100 mA
EMO (on T variant only) 6 - common and 7 - normally closed	CPC 7-way plug, standard gender, socket contacts 30 V d.c. 0.5 A	
EMS* External emergency stop switch 1 - supply, 2 - return Internal emergency stop switch 3 - common, 4 - normally open Comms supply 5 - supply, 6 - return	XLR type 6-way plug  30 V a.c. 1 A 60 V d.c. 0.55 A	24 V d.c. 100 mA   24 V d.c. 0.5 A
Accessory module interface*	Preh locking DIN 8-way plug	24 V d.c. 1.3 A
GRC interface* 1 - Normally open and 3 - common 2 - Normally open and 4 - normally closed 5 - Normally open and 6 - common	DIN type 6-way plug 30 V a.c. 1 A 30 V d.c. 1 A 60 V d.c. 0.5 A	

## 2.5 General Data

Table 6 - Technical data

Item	Description	Rating	Units
Electrical	Supply voltage 3-phase	200/230 V, 50/60 Hz a.c. 380/460 V, 50/60 Hz a.c.	V
	Recommended fuse/isolator rating	Full load current rating, refer to Table 3. Class CC fuse rated to 600 V.	
	Voltage tolerance range	+ 10%	V
	Installation category	II (IEC 664)	
	Earth leakage	≤ 6	mA
	Harmonic voltage distortion factor	5%	
Water-cooling system	Maximum supply pressure	100	psig
	Minimum supply pressure	36	psig
	Minimum flow rate required	Refer to Table 1	l min <sup>-1</sup>
	Cooling-water supply temperature range	10 - 30	°C
	Maximum particle size	0.03	mm <sup>2</sup>
	Acidity	6.5 to 8.0	pH
	Hardness	< 100	ppm
	Resistivity	> 1	k cm
	Solids (turbidity)	< 100	ppm
	Materials in contact with cooling-water	Stainless steel, PTFE, copper, brass and fluoroelastomer.	
Connections	Cooling-water	¼" BSPT male	
	Nitrogen	¼" tube fitting	
Materials in contact with process gas	Pump, shafts and rotors	Cast SG iron, steel, aluminium	
	Seals	PTFE and fluoroelastomer	
Operating conditions	Intended Use:	Indoor use	
	Ambient temperature range:		
	Operating	+5 to +40	°C
	Storage	-45 to +55	°C
	Relative humidity	10 to 90	%
	Maximum operating altitude	2000	m
Pollution degree	2 (IEC 61010)		

## 3 Installation



### WARNING

Obey the safety instructions given below and take the appropriate precautions. If you do not, you can cause injury to people and damage to equipment.



### WARNING

The system should not be operated with the Edwards panels removed.

Potential hazards on the dry pumping system include electricity, hot surfaces, process chemicals, Fomblin<sup>®</sup> oil, nitrogen and water under pressure.

Detailed safety information is given in Edwards Publication Number P300-20-000 'Vacuum Pump and Vacuum System Safety'.

- Only Edwards engineers may install the dry pumping system. Users can be trained by Edwards to conduct the tasks described in this manual, contact your local service centre or Edwards for more information.
- Do not remove the temporary cover or blanking plate from the dry pumping system inlet and exhaust until you are ready to connect the dry pumping system to your vacuum or exhaust-extraction system. Do not operate the dry pumping system unless the inlet and exhaust are connected to your vacuum and exhaust-extraction system.
- Vent and purge the process system (if the dry pumping system is to replace an existing pumping system) with nitrogen for 15 minutes before you start installation work. Refer to [Section 4](#).
- Disconnect the other components in the process system from the electrical supply so that they cannot be operated accidentally.
- Electrical, nitrogen and water supplies are all potentially hazardous energy sources. Before carrying out any maintenance the supply of these sources should be locked and tagged out.
- Route and secure cables, hoses and pipework during installation to avoid possible trip hazards.
- The pump system includes provision for ventilation extraction and secondary containment of oil and water leaks. Any unintended overflows or spills must be removed immediately to avoid risk of slips.
- Obey all national and local rules and safety regulations when you install the dry pumping system. Consult Edwards Publication Number P300-20-000 (Vacuum Pump and Vacuum System Safety) before you pump hazardous materials. This publication is available on request: contact your supplier or Edwards.



### 3.1 Locate the dry pumping system



#### WARNING

You must use suitable lifting equipment to move the system. It is too heavy to lift by hand.



#### WARNING

Do not exceed the topple angle of 10 ° when moving the pump. Wheel the system on its castors to move it into its operating position. The system should only be wheeled short distances over flat surfaces. If the floor surface is uneven or has obstacles the system should be lifted with suitable lifting equipment.

Use the following procedure to locate the iGX system in its operating position. The iGX system must be located on a firm, level surface, to ensure that the system is not damaged.

1. Use suitable lifting equipment (refer to [Figure 2](#)) attached to the lifting eyebolt (15) to move the iGX system close to its final operating position.
2. Adjust the levelling feet (24) to make sure that the iGX system is level and is not supported by the castors. The lifting eyebolt must be retained for future use with this system.
3. If required, the iGX system can be secured to the floor by fitting suitable bolts or studs (not supplied) through the M10 docking points on the chassis.  
If vibration transmission to the floor is a concern, suitable vibration isolators (not supplied) should be fitted between the docking points and the bolt or stud, if doing this the levelling feet will need to be removed.
4. If preferred, the lifting eyebolt can be removed and replaced with the lifting eyebolt hole plug supplied with the systems.
5. Ensure that access is possible to the emergency stop button (refer to [Figure 4](#), item 1), if not use an iGX Disconnect Box (refer to [Section 7.3](#)).

**Figure 7 - System arrangement to reduce effective footprint (if required)**

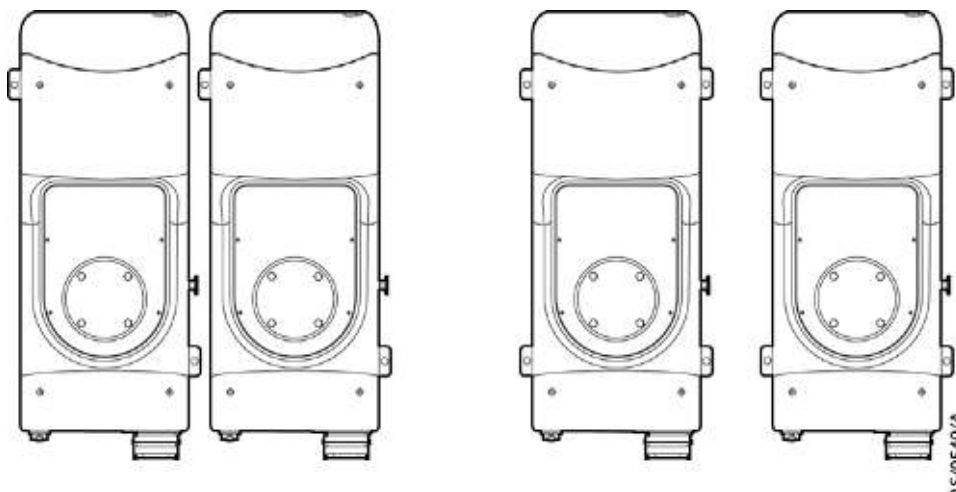

If you want to secure the iGX in place to prevent inadvertent movement (for example, during an earthquake), take note of the following:

- The iGX system seismic brackets ([Figure 2](#), item 19) are designed to withstand a level 4 earthquake in a ground floor installation.

- The iGX system can be secured to the floor by fitting suitable bolts or studs (not supplied) through the 17.5 mm hole in the seismic brackets.
- If vibration transmission to the floor is a concern, suitable vibration isolators (not supplied) should be fitted between the seismic brackets and the bolt or stud.
- Although the iGX system is supplied with four seismic brackets, two brackets are capable of protecting the system during an earthquake. The system can therefore be secured as shown in [Figure 7](#) for example, to reduce the effective system footprint if required.
- If all four seismic brackets are to be used, ensure that the bolt spacing is adequate for the floor strength and loads anticipated.

## 3.2 Lubrication

The iGX system is given a charge of oil before it leaves the factory. There is no requirement to check and adjust the oil level.

## 3.3 Connect the iGX system to your vacuum/exhaust system and interstage connection (if fitted)



### WARNING

Pipe the exhaust to a suitable treatment plant to prevent the discharge of dangerous gases or vapours to the surrounding atmosphere.



### WARNING

Do not operate the system with the exhaust pipeline blocked. If the exhaust pipeline is blocked, the system can generate exhaust pipeline pressures of up to 7 bar ( $7 \times 10^5$  Pa).

Do not reuse any O-ring or O-ring assembly and do not allow debris to get into the iGX system during installation.

When you connect your iGX system to your vacuum system, take note of the following:

- To get the best pumping speed, ensure that the pipeline which connects the vacuum system to the iGX system is the minimum length possible and has an internal diameter not less than the iGX system inlet-port.
- Ensure that all components in the vacuum pipeline have a maximum pressure rating which is greater than the highest pressure that can be generated in your system.
- Incorporate flexible pipelines in the vacuum pipeline to reduce the transmission of vibration and to prevent loading of coupling-joints. We recommend that you use Edwards braided flexible pipelines. The pipelines should be suitable for 110 °C.
- Adequately support vacuum/exhaust pipelines to prevent the transmission of stress to pipeline coupling-joints.
- Incorporate a pressure gauge in the inlet pipeline, so that you determine that the iGX system operates correctly.
- You must be able to isolate the iGX system inlet from the atmosphere and from your vacuum system if you have pumped or produced corrosive chemicals.

The outlet of the exhaust pipe can have a check-valve (optional accessory) fitted which prevents the suck-back of exhaust vapours after the iGX system is shutdown. The check-valve also provides additional attenuation of the pulses in exhaust pressure.

Refer to [Figure 2](#), items 16, 18 and 27. Use the following procedure to connect the inlet and exhaust of the iGX system to your vacuum inlet and exhaust pipeline:

1. Remove the temporary cover or blanking plate from the inlet of the iGX system. Retain the nuts, bolts, washers and blanking plate for future use. Retain the temporary cover for future use on non-contaminated pumps only.
2. Use the O-ring supplied and suitable nuts, bolts and washers (not supplied) to connect the inlet-flange ([Figure 2](#), item 16) of the iGX system to your vacuum system.
3. Use the NW25 trapped O-ring and clamp supplied to connect the exhaust outlet ([Figure 2](#), item 27) on the exhaust pipe, to your exhaust extraction system.
4. Use the NW16 trapped O-ring and clamp supplied to connect the interstage connection ([Figure 2](#), item 18) if fitted.

### 3.4 Connect to your factory extraction system (optional)

Refer to [Figure 2](#), item 27.

### 3.5 Connect the nitrogen supply (if provided)

---

#### CAUTION

Ensure that your nitrogen supply conforms to the requirements given in the Technical Data Section. If it doesn't flow, the sensors may not operate correctly, the gas pipelines may become blocked or the iGX system may be damaged.

---

Refer to [Figure 2](#), item 21.

*Note:* For optimum nitrogen, ensure that your nitrogen supply complies with [Table 2](#).

#### 3.5.1 Flammable/pyrophoric materials



---

#### WARNING

You must obey the instructions and take note of any precautions given below to ensure that pumped gases do not enter their flammable ranges.

---

When flammable or pyrophoric materials are present within the equipment you must:

- Not allow air to enter the equipment
- Ensure that the system is leak tight
- Ensure that pumped gases do not enter their flammable range. This can be achieved by diluting flammable gases/vapours or oxidisers in the pump by supplying sufficient inert gas purge, for example dilution with nitrogen to below one quarter LEL (lower explosive limit) or, if that is not practical, to below 60% LOC (limiting oxidant concentration).
- For further information please refer to Semiconductor Pumping Application Guide (Publication no. P411-00-090) or contact Edwards: refer to the address page at the rear of this manual for details of your nearest Edwards company.

### 3.5.2 Gas Purges



#### WARNING

If you use inert gas purges to dilute dangerous gases to a safe level, ensure that the pump is shut down if an inert gas supply fails.

Switch on the inert gas purge to remove air from the pump and the exhaust pipeline before the process starts. Switch off the purge flow at the end of the process only after the remaining flammable gases or vapours have been purged from the exhaust pipeline.

If liquids that produce flammable vapours could be present in the pump foreline, then the inert gas purge to the dry pumping system should be left on all the time this liquid is present. Flammable liquids could be present in the foreline as a result of condensation or may be carried over from the process.

When calculating the flow rate of inert gas required for dilution, consider the maximum flow rate for the flammable gases/vapours that could occur. For example, if a mass flow controller is being used to supply flammable gases to the process, you should assume a flow rate for flammable gases that could arise if the mass flow controller is fully open.

Continually measure the inert gas flow rate: if the flow rate falls below that required, then the flow of flammable gases or vapours to the pump must be stopped.

## 3.6 Leak-test the iGX system



#### WARNING

Leak test the system after installation and seal any leaks found to prevent leakage of dangerous substances out of the system and leakage of air into the system.

**Note:** If you need further information on leak-testing, look it up on the Edwards website at [www.edwardsvacuum.com](http://www.edwardsvacuum.com), or contact your supplier or Edwards for advice.

Refer to Figure 2, item 28.

### 3.7 Connect the electrical supply



#### WARNING

This equipment is suitable for Installation Category II as defined in IEC 60664-3. Connect the system to the electrical supply through a suitably rated isolator/connector for your dry pumping system.



#### WARNING

Ensure that the system and your electrical supply cable are suitably protected against earth (ground) faults and that the earth (ground) conductor of the electrical supply cable is longer than the phase conductors in the connector. You must fit a second protective earth (ground) conductor (with a cross-sectional area at least equal to phase conductor size) to the protective earth (ground) stud.



#### WARNING

All connections to the interface control must be double insulated or have equivalent protection. Do not connect voltages greater than 30 V a.c. or 60 V d.c. to the control/interface connections. If you do, the interface control will not provide protection against electric shock.



#### WARNING

There is no overload protection provided on the Systemable (T variant) system.

#### CAUTION

This is an industrial (Class A) product as defined by EN61326. To ensure compliance with European Electromagnetic Compatibility (EMC) requirements for EMC emissions, please note that it is not intended for use in domestic buildings, or in properties directly connected to an electrical supply network which also supplies domestic buildings.

#### CAUTION

Do not connect voltages greater than specified in Table 5 to the control/interface connections. If you do, the interface control may be damaged.

**Notes:** Edwards recommend that the electrical supply be connected to a suitable isolator, which is easily accessible for maintenance and clearly identified.

If you need further information on connecting the electrical supply, look it up on the Edwards website at [www.edwardsvacuum.com](http://www.edwardsvacuum.com), or contact your supplier or Edwards for advice.

Refer to Figure 2, item 2.

Use the following procedure to connect the electrical supply to the iGX system. When you make the electrical supply cable, ensure that the earth (ground) conductor is longer than the phase conductors. This will ensure that if the cable is accidentally dragged and the strain relief bush on the electrical supply connector mating-half fails, the earth (ground) conductor will be the last conductor to be pulled from the connector.

You must fit a secondary protective earth (ground) conductor (with a cross-sectional area at least equal to phase conductor size) to the protective earth (ground) stud.

**Remote:**

1. Attach the strain relief bush to the cover. Then pass a suitable cable through the strain relief bush and cover. The cross-sectional area of the cable wires should be 6 mm<sup>2</sup>. Phase wires must be bare ended without ferrules to ensure correct clamping in the connector block.
2. Fit the coding pins to the connector block according to the voltage variant as shown in Figure 8 'High and low volt coding pin arrangement'.
3. Connect the cable phase wires to the following connections on the connector block. Refer to Figure 9.
  - R/L1 to a1
  - S/L2 to a2
  - T/L3 to b1
  - Prepare the end of the 6 mm<sup>2</sup> wire as shown in Figure 9. Do not twist the wire further.
  - Insert the wire into the appropriate contact chamber.

Tighten the connection using a 2 mm allen key as shown in Figure 9 to a torque of 1 Nm. During tightening firmly hold the wire in position.

4. Connect the earth (ground) wire of the cable to one of the two earth (ground) connections on the connector block using the following procedure:
  - Prepare the end of the 6 mm<sup>2</sup> wire to a strip length of 10 mm. Twist strands or fit a ferrule.
  - Insert the wire into the earth terminal block.
  - Tighten the connection using a flat blade screwdriver.

5. Refit the cover to the connector block, then tighten the strain relief bush.

6. Connect the mating half to the electrical supply connector of the iGX system (Figure 2, item 2).

Connect the other end of the electrical supply cable to your electrical supply through a suitable isolator.

**Figure 8 - High and low volt coding pin arrangement**

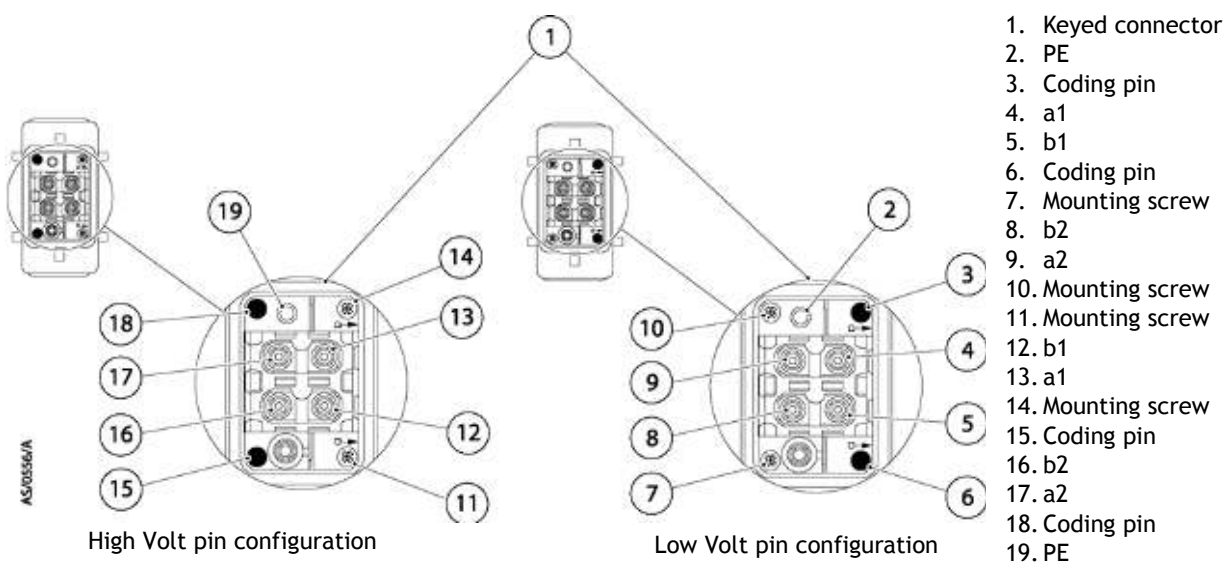
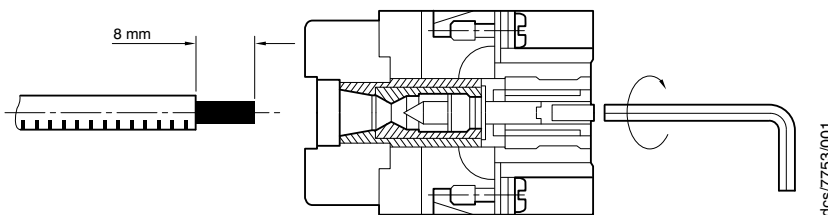

Figure 9 - Method for connecting phase wires



**Systemable (T variants):**

Connect the end of the supplied electrical supply cable to your electrical supply through a suitable isolator with overload protection in accordance with local regulations - refer to the Technical Data section for pump system rating.

### 3.8 Connect an additional RF earth (ground) (optional)

If you will operate the iGX system in an area subject to high RF (radio frequency) emissions, in accordance with good RF installation practice, we recommend that you:

- Use a star washer to connect the end of the earth (ground) cable (Figure 2, item 17) connected to the iGX inlet to one of the bolts that you use to secure the inlet-flange.
- Connect an additional earth (ground) cable to the RF earth (ground) stud (Figure 2, item 26). You must use a suitable low-impedance cable (for example, use braided cable).

### 3.9 Connect to your emergency stop circuit

**Systemable (T variants):**

The pump electrical supply (Figure 2, Item 2) must be connected to an emergency stop facility. The operation of the emergency stop function must immediately disconnect power from the pump when the emergency stop control is operated. Returning the emergency stop control to its normal position must not result in power being re-applied to the pump; a separate start or reset control must be used for this.

The EMO connector (Figure 2, item 10) must also be connected to an emergency stop facility to stop the pump immediately, in the same way as the emergency stop function. Refer to Figure 10 and Table 5 for connection details.

Figure 10 - Connections to emergency stop circuit (systemable)

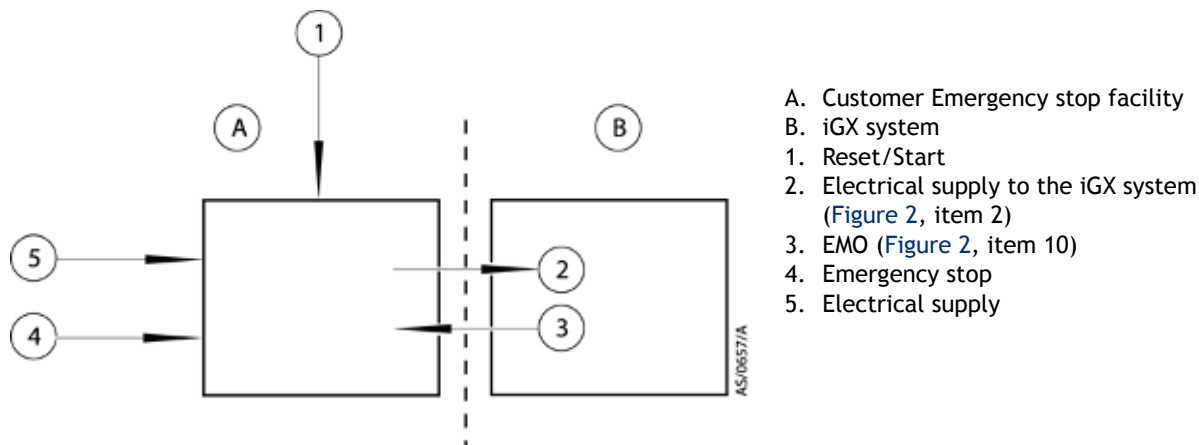

**Remote (optional):**

**Note:** If you do not connect to your own control equipment, you must fit the external EMS shorting plug supplied to the EMS connector (Figure 2, item 11) on the rear of the iGX system. If you do not, you will not be able to operate the iGX system.

If required, you can connect your own control equipment to the iGX system to shut it down in an emergency using the EMS connection (Figure 2, item 11 and Table 5). The emergency stop control must be compliant with IEC 60947-5-1 (This should be a red self latching mushroom push button on a yellow background).

### 3.10 Connect the cooling-water hoses

**WARNING**

Do not leave the cooling-water supply turned on until after you complete the electrical installation of the pump. If you do, condensation may form inside the enclosure and there may be a risk of electric shock.

**Note:** For optimum water-cooling, ensure that your cooling-water supply complies with the data given in Table 1 and that they are connected in parallel. Refer to Figure 11. Edwards recommend that quick connectors (provided) be used to reduce the risk of water spillage during connection/disconnection.

Connect the cooling-water supply as follows:

1. Remove the dust-caps from the cooling-water inlet and outlet.
2. Apply Loctite 577 (not supplied) to all male threads prior to installation.
3. Connect the reducing bushing (3) to the threaded end of the coupler (2).
4. Connect this sub-assembly to the water return port on the pumping system (4).
5. Connect the threaded end of the nipple (1) to the customer water return line.
6. Connect the reducing bushing (3) to the threaded end of the nipple (1).
7. Connect this sub-assembly to the water supply port on the pumping system (5).
8. Connect the threaded end of the coupler (2) to the customer water supply line.
9. Connect the customer supply and return hoses to the pump.
10. Turn on the cooling-water supply.
11. Inspect the water hoses, pipelines and connections and check that there are no leaks.

Turn off the water supply while you complete the remainder of the installation procedures.

### 3.11 Accessories

Refer to the individual accessories manuals for installation, information, refer to Section 7.3.

The disconnect box when fitted, is used to energize and isolate the power supply to the system. It also allows the isolation of the electrical supply during an emergency, and for maintenance and trouble shooting the system, thereby satisfying SEMI S2 requirements. The photohelic switch/gauge when fitted, allows monitoring for loss of extraction from the enclosure, thereby satisfying SEMI S2 requirements.



### 3.12 Commission the iGX system



#### WARNING

During some application cycles it is possible that the system may exceed OSHA 1910.95 Occupational Noise Exposure Limits, the EU noise directive 2003/10/EC or other regional noise limits dependant upon the process, duty cycle, installation or environment in which being operated. A sound pressure survey must be conducted after installation and, if necessary, controls implemented to ensure that the relevant limits are not exceeded during operation and that adequate precautions are taken to prevent personnel from exposure to high noise levels during operation.

1. Switch on the external electrical supply and check that the power OK LED (Figure 4, item 9) goes on. If the LED does not go on, Contact Edwards or refer to the Edwards website.
2. Switch on the cooling-water and nitrogen supplies.
3. Ensure that the exhaust-extraction system is not blocked (for example, that valves in the exhaust-extraction system are open).
4. Ensure that all openings to atmospheric pressure in the foreline vacuum system are closed.
5. Press local control button (Figure 4, item 5). The green LED will illuminate. Then press the Start button (Figure 4, item 2).
6. If the iGX system starts and continues to operate, continue at Step 7. If a warning or alarm condition is indicated:
  - Shut-down the iGX system: refer to Section 4.3.
  - Contact Edwards or refer to the Edwards website.

Figure 11 - Installing 3/8" quick connect fittings (provided)

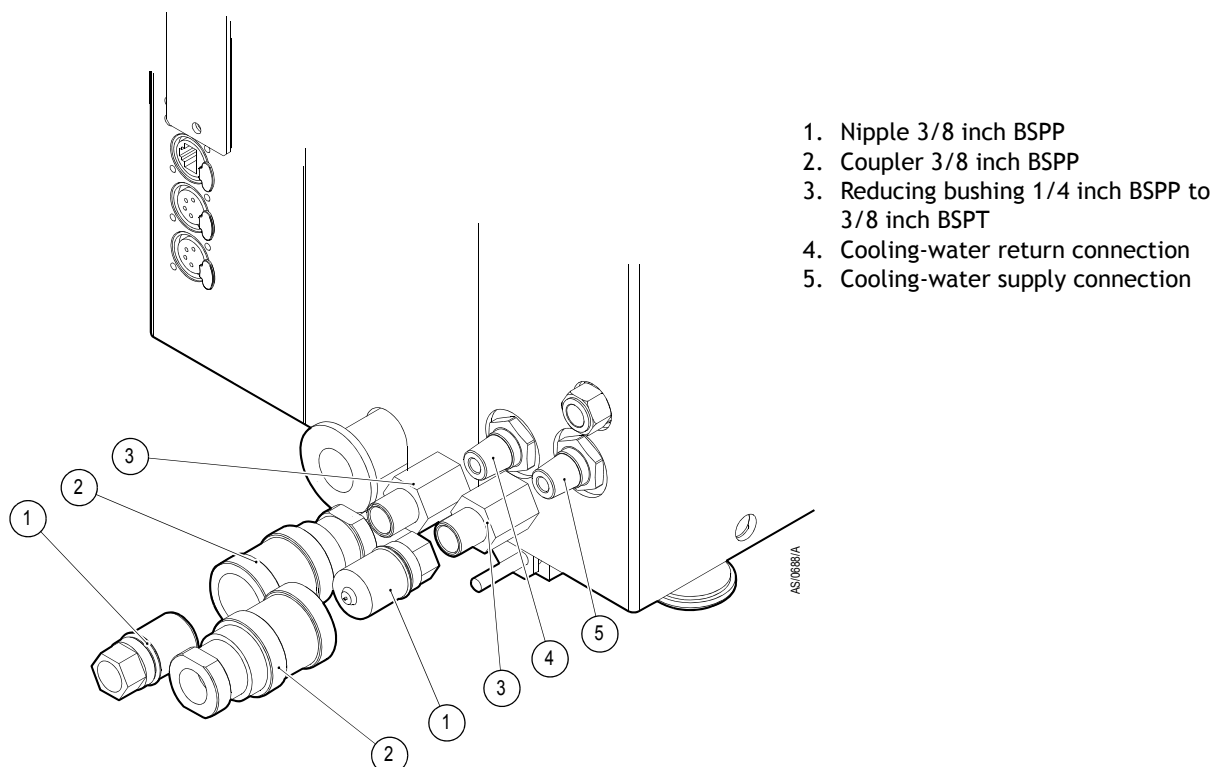

1. Nipple 3/8 inch BSPP
2. Coupler 3/8 inch BSPP
3. Reducing bushing 1/4 inch BSPP to 3/8 inch BSPT
4. Cooling-water return connection
5. Cooling-water supply connection

7. If your iGX system is an L or M variant, continue at step 8.

For N variants, the nitrogen purge flow should be checked as follows;

- i. Open the gas module access panel by removing the securing screw. Refer to [Figure 12](#) for the iGX100, (same location for iGX600).
- ii. Confirm the flow is 14 slm (factory default setting). The centre of the ball should be aligned to the 14 slm marking on the flow tube (refer to [Figure 13](#)).

If not, then proceed at step (iii);

- iii. Close (clockwise) the 4/5 variable restrictor (marked 4/5) and confirm the flow rate is 4 slm. If not, then adjust the shaft seals variable restrictor (marked SS) until the flow tube indicates a flow rate of 4 slm (refer to [Figure 14](#)).
- iv. Open (anti-clockwise) the 4/5 variable restrictor until the flow tube indicates a total flow of 14 slm (refer to [Figure 13](#)).
- v. Replace the gas module access panel.

**Figure 12 - Gas module access panel**

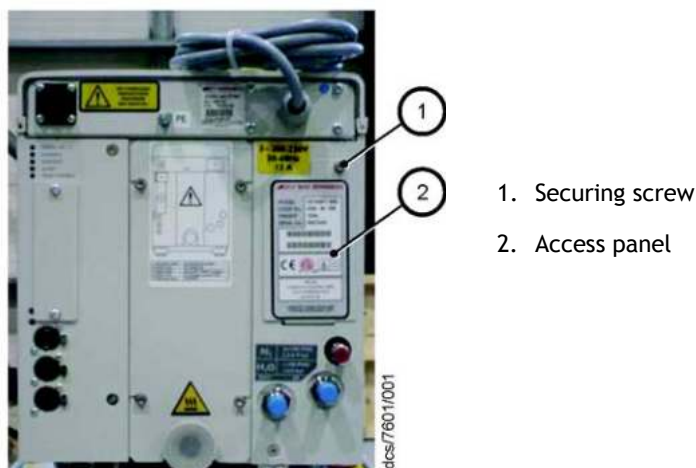

1. Securing screw
2. Access panel

**Figure 13 - Flow tube (14 slm)**



Figure 14 - Flow tube (4 slm)



If a different nitrogen flow rate is required please contact Edwards for further advice.

8. After you have commissioned the iGX system:

- If you want to continue to operate the iGX system, refer to [Section 4.1](#), step 4.
- Otherwise, shut-down the system: refer to [Section 4.3](#).

### 3.13 Install additional safety equipment



#### WARNING

If your Process Tool/control system needs to know the total flow rate of nitrogen to the system for safety reasons, install suitable measurement equipment in the nitrogen supply pipeline.



#### WARNING

If you use the nitrogen purges to dilute dangerous gases to a safe level, ensure that the system shuts down if the nitrogen supply to the system fails.

If the sensors or microprocessors fail, the total flow rate of nitrogen displayed or output by the iGX system may be incorrect. If you need to know the total flow rate of nitrogen to the dry pump for safety reasons, you should therefore fit suitable measurement equipment in the nitrogen supply pipeline. If you fit a rotameter, ensure that it is suitable for use with nitrogen and that it is correctly calibrated.

If the nitrogen supply to the iGX system fails, a warning message will be shown on the Pump Display Terminal (if fitted) and will be sent to the Interface Module(s) connected to the iGX system. Ensure that your installation is configured so that it remains safe if there is a failure of the nitrogen supply to the iGX system.

If an alarm condition is detected (and the iGX system is not configured to 'run til crash' refer to [Section 4.4](#)) the iGX system will shutdown automatically. You must ensure that your installation remains safe if the iGX system shuts down automatically.

## 4 OPERATION



### WARNING

Do not operate the system with any enclosure panels removed or damaged and do not touch any parts of the pump(s) when the system is on. Surfaces of the pump(s) are very hot and can cause injury to people.



### WARNING

Do not operate the system with any enclosures removed or damaged. If you do there may be a risk of an electric shock.

### 4.1 Start-up



### WARNING

Ensure that it is safe to start the system. If you do not (and, for example, maintenance is being performed on components downstream of the system), you could cause injury to people.



### WARNING

After the power is applied, the contactors will pull in automatically and all mains circuits will be energised.

### CAUTION

The system is designed to ride through short term power interruption and to automatically restart once the power is restored.

### CAUTION

Do not operate the pump if the pipeline is restricted or blocked as the pump will not operate correctly and may be damaged.

Refer to [Section 1.2](#).

1. Switch on the cooling-water supply.
2. Switch on the electrical supply.
3. Check that the exhaust-extraction system is not restricted, and that any valves in the exhaust-extraction system are open.

The pump can be started using either the MicroTIM, the PDT or the front panel local control membrane.

Front panel local control membrane operation:

4. To operate the system using the front panel local control membrane (refer to [Figure 4](#));
  - Press and hold the 'Local Control' button ([Figure 4](#), item 5). The Green LED will illuminate when control is taken. The message 'Keys in Control' will be displayed on the PDT if connected.
  - Press and hold the Start button ([Figure 4](#), item 2) until pumps starts and the Running LED ([Figure 4](#), item 8) is illuminated.

**MicroTIM operation:**

5. Use your control equipment to set the pump start/stop signal to the interface connector and check that the Running LED is illuminated.
  - Control must be taken with the MicroTIM. The message 'MicroTIM IN CONTROL' will be displayed on the PDT if connected.

**PDT operation:**

6. If the system is to be operated using the PDT;
  - Connect the PDT to the required PDT connection, front (Figure 4, item 10) rear (Figure 2, item 9)
  - Control must be taken with the PDT - press 'Control' button. The message 'PDT1 IN CONTROL' will be displayed if the front connection is used and the message 'PDT2 IN CONTROL' will be displayed if the rear connection is used.
  - Press Start button.
  - Press ENTER.
  - The system will start and the Running LEDs will be illuminated.

## 4.2 Status indicators

Refer to Figure 3 and 4.

## 4.3 Manual shut-down



### WARNING

If you shut the system down and don't isolate it from the electrical supply, do not disconnect the Pump Display Terminal or release control from the Pump Display Terminal or front panel. If you do the system could be started by another Module.



### WARNING

Do not remove the inlet connections until the pump has been allowed to stop rotating and the power has been isolated. The pump can take up to three minutes to completely stop.

The pump can be shutdown using either the MicroTIM, the PDT or the front panel local control membrane. Note that only the item in control can stop the pump (refer to Section 1.4).

**Front panel local control membrane operation:**

Press and hold the stop button (Figure 4, item 3) until the running LED (Figure 4, item 8) flashes. The running LED will then turn off when the pump has shutdown.

**MicroTIM operation:**

Use your control equipment to reset the pump start/stop signal to the interface connector. The Running LED (Figure 4, item 8) will then go off, and the pump running status output signal will open.

**PDT operation:**

Selecting either 'normal' or 'fast' shutdown will shut the pump down immediately.

If the pump is not going to be required for some time, switch off the electrical supply and the cooling-water supply.

## 4.4 Automatic shut-down

### CAUTION

If you select 'Run 'til crash', the pump(s) can be damaged and you may invalidate any warranties on the iGX system equipment.

Normally, if an alarm condition exists, the iGX control system will shutdown the iGX system. If required you can request 'run 'til crash' operation. In this mode of operation, most alarm conditions will be ignored and the pump(s) will continue to operate. For safety reasons the following alarms will shut-down the iGX system even if you have selected 'run til crash':

**Note:** 'Run 'til crash' is automatically reset to 'off' when the electrical supply is removed.

- POWERLOSS
- EMS
- DP ACTUAL SPEED
- DP THERMISTOR HIGH
- EXHAUST PRESSURE \*
- DP STATUS
- MB ACTUAL SPEED
- MB STATUS
- MB THERMISTOR HIGH

**Note:** \* M variants only

Table 7 - Safety sensors

Safety sensor	Shut-down condition
Dry pump motor thermal snap switch (PTO)	Power is shut-off to the motor if the motor winding temperature exceeds 150°C.
Inverter thermistor	Power is shut-off to the motor if the temperature exceeds 110°C.
Dry pump body temperature sensor*	Power is shut-off to the motor if the pump body temperature exceeds 160°C (Warning at 150°C).
Water circuit temperature sensor	Power is shut-off to the motor if the temperature exceeds 70°C (Warning at 60°C).

\* N and M variants only.

## 4.5 Unplanned shutdown and alarms

The iGX system is fitted with a number of pump protection sensors (refer to Table 7) that will give warnings and alarms. The decision on whether or not to shutdown the pump is left with the tool.

If the iGX system has an unplanned shutdown, ensure that the cause of the shutdown is identified and rectified before restarting. If you are in any doubt, please call a Edwards Service Engineer.

## 4.6 Emergency stop

**Note:** The emergency stop switch is not an electrical isolator.

To shut down the iGX system in an emergency, press the emergency stop switch (Figure 4, item 1). Alternatively, you can operate the emergency stop controls in your own control system if you have connected your emergency stop circuit to the iGX system as described in Section 3.9.

When emergency stop is selected:

- The pump (and the booster pump) is switched off.
- The solenoid-valve(s) in the Gas Module close, to switch off the supply of nitrogen to the pump.
- The solenoid-valve(s) in the temperature control manifold(s) de-energise with loss of temperature control.
- The Pump Display Terminal will display 'STOP ACTIVATED'. (If connected)
- The Running LED will go off.
- The Alarm LED illuminates.

## 4.7 Restart the pump after an emergency stop or automatic shut-down

**Note:** *If the iGX system has automatically shut down because of high pump power, check that the pump is free to rotate before you restart the iGX system: Contact Edwards or refer to the Edwards website.*

If you have used the emergency stop switch on the front panel to shut down the iGX system, you must reset the emergency stop switch before you can restart the iGX system. Turn the emergency stop switch to reset it, then restart the iGX system as described in [Section 4.1](#).

If the iGX system has been automatically shut down because of an alarm condition, the alarm condition must be rectified before you can restart the iGX system. Restart the iGX system as described in [Section 4.1](#).

## 4.8 Single equipment monitor (SEM)

---

### CAUTION

Ensure that you use the correct configuration setpoints for your application. If you do not, the iGX system may be damaged during operation.

---

If there is an SEM connected to your iGX system, you are able to download configuration sets, which contain preset configuration values, for example setpoints. Contact Edwards or go to the Edwards website for more details.

## 5 MAINTENANCE



### WARNING

Only personnel specially trained to perform electrical maintenance should attempt troubleshooting inside electrical enclosures. These enclosures contain hazardous voltages and are not operator areas.



### WARNING

Leak test the system after installation and seal any leaks found to prevent leakage of dangerous substances out of the system and leakage of air into the system.

### 5.1 Safety and maintenance frequency



### WARNING

Only personnel specially trained to perform electrical maintenance should attempt troubleshooting inside electrical enclosures. These enclosures contain hazardous voltages and are not operator areas.



### WARNING

Personal protection equipment should be checked and used as specified by its supplier. Hazardous chemicals that have been pumped are located within the pumps and piping. Use of suitable protective gloves and clothing along with a respirator is recommended if contact with substances is anticipated.

Particular caution should be exercised when working with Fomblin<sup>®</sup> oil which may have been exposed to temperatures greater than 260 °C. Refer to Edwards Material Safety Data Sheets for detailed information.

- Ensure that the maintenance technician is familiar with the safety procedures which relate to the products pumped.
- Allow the pumps to cool to a safe temperature before you fit lifting bolts or start maintenance work.
- Vent and purge the dry pumping system with nitrogen before you start any maintenance work.
- Isolate the dry pumping system and other components in the process system from the electrical supply so that they cannot be operated accidentally. Note that the emergency stop switch on the dry pumping system is **not** an electrical isolator, unless a disconnect box accessory is installed.
- Wait for at least four minutes after you have switched off the electrical supply before you touch any electrical component on the dry pumping system.
- Route and secure cables, hoses and pipelines during maintenance to avoid possible risk of trips or entrapment.
- Ensure that any oil or water collected in the secondary containment drip tray is removed before moving the system.
- The enclosure panels should only be removed with the use of a special tool, when the system has been switched off and allowed to cool sufficiently (as an indication the system should be left for one hour with cooling water still connected at the flow rate specified in [Table 1](#)).



- Wear the appropriate safety-clothing when you come into contact with contaminated components. Dismantle and clean contaminated components inside a fumecupboard.
- Take care to protect the sealing-faces from damage.
- Do not touch or inhale the thermal breakdown products of fluorinated materials which may be present if the iGX system has been overheated to 260 °C and above. These breakdown products are very dangerous. Fluorinated materials in the iGX system may include oils, greases and seals. The iGX system may have overheated if it was misused, if it malfunctioned or if it was in a fire. Edwards Material Safety Data Sheets for fluorinated materials used in the pump are available on request: contact your supplier or Edwards (refer to the address page at the rear of this manual for contact details).

The iGX system requires little user maintenance. Safety sensors fitted to the iGX system do not require routine maintenance. The maintenance operations you can carry out are described in the following sections, any other maintenance must be carried out by Edwards service centres (refer to [Section 7](#)). The frequency of maintenance operations depends on your process. Adjust the frequency of maintenance operations according to your experience.

When you maintain the iGX system, use Edwards maintenance and service kits. These contain all of the necessary seals and other components necessary to complete maintenance operations successfully. Ensure that your nitrogen and cooling-water supplies comply with the data given in [Section 2.1](#) and that they are connected in parallel. Contact Edwards or refer to the Edwards website.

## 5.2 Relocate the system for maintenance



### WARNING

The substances that accumulate in the exhaust-pipe, elbow and check-valve (supplied separately) can be dangerous. Do not allow these substances to come into contact with your skin or eyes. Do not inhale vapours from these substances. Fit blanking caps to the inlet and outlet flanges when you move the exhaustpipe, elbow or check-valve around your workplace.



The majority of synthetic oils/grease can cause inflammation of the skin (dermatitis). Safety precautions must be taken to prevent prolonged skin contact with these substances. Use of suitable protective gloves and clothing along with a respirator is recommended if contact with the substance is anticipated.



System process gases and residue can be highly toxic. Take all necessary precautions when handling components that have, or could have, come into contact with them, including O-rings, lubricants and all exhaust accessories.



### WARNING

You must use suitable lifting equipment to move the system. It is too heavy to lift by hand.



### WARNING

Do not exceed the topple angle of 10° when moving the pump. Wheel the system on its castors to move it into its operating position. The system should only be wheeled short distances over flat surfaces. If the floor surface is uneven or has obstacles the system should be lifted with suitable lifting equipment.

### CAUTION

Drain the cooling-water from the iGX system as stated in [Section 5.3](#), if you will transport or store it in conditions where the cooling-water could freeze. If you do not, cooling-water may freeze in the iGX system and damage the pump(s) and/or the cooling-water pipelines.

If you want to remove the iGX system from its operating location and move it to another location where you will do maintenance, use the following procedure:

1. Purge the iGX system and shut down the iGX system as described in [Section 4](#) and allow the iGX system to cool down.
2. Isolate the power by disconnecting the mating-half from the electrical supply connector, then isolate the water and the gas purge supply.
3. Switch off your nitrogen and cooling-water supplies. Disconnect the nitrogen supply, taking care as any trapped gas under pressure is released. Disconnect the cooling-water supply followed by the cooling-water return.
4. Disconnect the inlet and outlet from the vacuum and exhaust systems and fit blanking caps.
5. If necessary, disconnect the iGX air-extraction port from your factory extraction system.
6. If necessary disconnect any accessories from the iGX system.
7. Adjust the levelling feet so that the iGX system rests on the castors.
8. Move the iGX system to the location where you will do maintenance.

After maintenance is complete, re-install the iGX system as described in [Section 2](#).

### 5.3 Draining the cooling-water



#### WARNING

Personal protection equipment should be checked and used as specified by its supplier. Use of suitable protective gloves and eye protection is recommended when carrying out this procedure.

1. Relocate the system for maintenance as stated in [Section 5.2](#).
2. Connect a regulated clean dry air supply (20 psig) to the cooling-water supply connection ([Figure 2](#), item 22). Do not turn on the air supply yet.
3. Connect a drain hose to the cooling-water return connection ([Figure 2](#), item 25). Position the open end of the drain hose in a suitable collection container.
4. Turn on the clean dry air supply.
5. Monitor the drain hose outlet until no further cooling-water is purged. If the system is a load-lock (L) the procedure is complete. If the system is an N or M variant continue at step 6.
6. Connect the iGX system to a suitable mains electrical supply. The iGX control system will now energise each temperature control valve in sequence for a period of ten seconds, purging the cooling-water from all flow paths. After a period of one minute from connection of the electrical supply, ensure no further cooling-water is being purged. If there is, repeat the entire procedure.
7. The cooling-water drain procedure is now complete. Disconnect the air supply, electrical supply and the drain hoses. Dispose of the drained cooling-water accordingly.

## 5.4 Cleaning the pump

---

### *CAUTION*

Do not use cleaning materials based on strong alkalis, aggressive or chlorinated solvents. Do not use cleaning materials containing abrasives.

---

Inspect the pump monthly and, if necessary, wipe the outside clean with a soft lint free cloth and a proprietary cleaning material based on demineralised water or isopropanol.

## 6 TRANSPORTATION, STORAGE AND DISPOSAL

### 6.1 Transportation



#### WARNING

Do not drain the oil from the pump(s) whether dangerous substances have been pumped or not. You must fit blanking plates to seal all vacuum inlet and outlet ports (to prevent possible oil leakage). You must ensure that the system is correctly labelled, if in doubt contact Edwards.

Follow the procedure laid out in [Section 6.2](#) and then read form HS1 and fill out form HS2, which can be found at the back of this manual.

### 6.2 Storage

#### CAUTION

Drain the cooling-water from the iGX system, if you will transport or store it in conditions where the cooling-water could freeze. If you do not, the cooling-water may freeze in the iGX system and damage the pump(s) and/or the cooling-water pipelines.

Store the iGX system as follows:

1. Follow the procedure set out in [Section 5.2](#).
2. Store the iGX system in clean dry conditions until required.
3. When required for use, prepare and install the iGX system as described in [Section 3](#) of this manual.

### 6.3 Disposal



#### WARNING

Dispose of the system and any components safely and in accordance with all local and national safety and environmental requirements.

Edwards products are supported by a world-wide network of Edwards Service Centres. Each Service Centre offers a wide range of options including disposal. Refer to [Section 7.2](#) for more information.

Pump system materials suitable for recycling include cast iron, steel, SG iron, PTFE, stainless steel, brass, aluminium, zinc alloy, nickel, mild steel, ABS.

Take particular care with the following:

- Fluoroelastomers which may have decomposed as the result of being subjected to high temperatures
- Components which have been contaminated with dangerous process substances
- Lithium battery.

## 7 SERVICE, SPARES AND ACCESSORIES

### 7.1 Introduction



#### WARNING

Whenever you return the dry pumping system to a Edwards Service Centre or other Edwards company, you must comply with the requirements of the Return of Edwards Equipment Procedure (refer to forms HS1 and HS2 at the rear of this manual).

**Notes:** Whenever you return the iGX system to a Edwards Service Centre or other Edwards company, you must comply with the requirements of [Section 7](#) and with the requirements of the Return of Edwards Equipment Procedure (refer to forms HS1 and HS2 at the rear of this manual).

*You must not drain the oil from the iGX pump. You must clearly state the pump is full of oil when you complete form HS2.*

Edwards products, spares and accessories are available worldwide from Edwards's companies and our network of distributors. Please refer to the back page of this manual or [www.edwardsvacuum.com](http://www.edwardsvacuum.com) for contact information. The majority of these centres employ service engineers who have undergone comprehensive Edwards training courses.

Order spare parts and accessories from your nearest Edwards company or distributor. When you order, please state for each part required:

- Model and Item Number of your equipment
- Serial number (if any)
- Item Number and description of the part.

### 7.2 Service

Edwards products are supported by a world-wide network of Edwards Service Centres. Each Service Centre offers a wide range of options including: equipment decontamination; service exchange; repair; rebuild and testing to factory specifications.

Equipment that has been serviced, repaired or rebuilt is returned with a full warranty. Your local Service Centre can also provide Edwards engineers to support on-site maintenance, service or repair of your equipment.

For more information about service options, contact your nearest Service Centre or other Edwards company.

## 7.3 Ordering accessories

Table 8 - Accessories

Accessory	Item number
iGX photohelic switch/gauge kit	A507-27-000
iGX disconnect box 200/230 V, 50/60 Hz a.c.	A507-28-000
EMS module*	
SPI	D373-70-310
MCM	D373-70-320
LAM Alliance	D373-70-350
C3	D373-70-360
MicroTim	
SPI	D373-60-310
MCM	D373-60-320
TEL	D373-60-330
E73	D373-60-340
LAM Alliance	D373-60-350
C3	D373-60-360
Hitachi	D373-60-370
Gate valve connection lead*	A532-08-403
Pump Display Terminal 5-way XLR plug(PDT)	D372-80-700
Extension cables	
5 way XLR, 3 m	D373-70-591
5 way XLR, 5 m	D373-70-592
5 way XLR, 10 m	D373-70-595
5 way XLR, 15 m	D373-70-596
5 way XLR, 25 m	D373-70-597
Stainless steel water quick disconnects	
1/4" BSPP straight Snap-tite	A507-17-000
1/4" BSPP straight Parker	A507-18-000
1/4" BSPP 90° Snap-tite	A507-19-000
1/4" BSPP 90° Parker	A507-20-000
3/8" BSPP straight Snap-tite	A507-21-000
3/8" BSPP straight Parker	A507-22-000
3/8" BSPP 90° Snap-tite	A507-23-000
3/8" BSPP 90° Parker	A507-24-000
Brass water quick disconnects	
3/8" BSPP 90° Snap-tite	A507-48-000
Flow control valve	
1 lpm (100 only)	A507-38-000
2 lpm (3/100, 6/100 and 10/100 only)	A507-39-000
PDT holster	D372-09-800

**Table 8 - Accessories (continued)**

Accessory	Item number
PDT Adaptor, 5-way XLR plug/RJ12 socket	D373-70-526
Exhaust enclosure kits	
iGX check valve loadlock (L)	A507-43-000
iGX check valve process (N and M)	A507-44-000
iGX check valve with enclosure loadlock (L)	A507-45-000
iGX check valve with enclosure process (N and M)	A507-46-000
Accessory Support Module (ASM)	D373-70-761
iGX Water flow switch kit (Pump) <sup>†</sup>	A507-16-000
iGX Water flow switch kit (Combination) <sup>†</sup>	A507-25-000
iGX Water flow monitor kit <sup>†</sup>	A507-26-000

\* Not on T variant

<sup>†</sup> ASM required